



lightsup
yourway

2017

	0501		53		3094	REG. 70 ECE/ONU E	85		3117	E	18
	202.01		50		3095	REG. 70 ECE/ONU E	85		3118	E	46
	236		84		3096	E	84V		3119	E	72/73
	3002	E	81		3096	DGV	85		3120	E	67
	3003	E	81		3097	E	84		3121	E	28
	3004	E	81		3098	E	84		3122	E	50
	3006	E	81		3101	E	51		3123	E	50
	3007	E	82		3104	E	80		3124	E	52
	3009	E	82		3107	E	80		3125	E	44
	3010	E	82		3108	E	79		3126	E	44
	3011		82		3110	E	66		3127	E	36
	3012	E	82		3111	E	43		3128	E	49
	3013	E	83		3112		80		3129	E	60
	3014	E	83		3113	E	52		3130	E	67
	3015	E	83		3114	E	45		3131	E	76
	3016	E	83		3115		74		3132	E	47
	3092	DIN 11030/TPESC	84		3116	E	45		3132	E	48

3133 (E) LED 76	3157 (E) LED WATER PROOF DUAL VOLTAGE 56	3170 (E) NEW PRODUCT 71
3134 (E) 76	3158 (E) LED WATER PROOF DUAL VOLTAGE 57	3171 LED DUAL VOLTAGE 75
3135 (E) LED WATER PROOF 78	3159 (E) LED WATER PROOF DUAL VOLTAGE 39	3172 (E) 38
3136 (E) LED WATER PROOF 77	3160 (E) 26	3173 (E) 51
3137 (E) LED 78	3161 (E) 16	3174 (E) LED WATER PROOF DUAL VOLTAGE NEW PRODUCT 71
3138 (E) 14/15	3162 (E) 17	3175 (E) 10/11
3139 (E) 34	3163 (E) 12	3177 (E) NEW PRODUCT 24/25
3141 (E) LED WATER PROOF DUAL VOLTAGE 58/59	3164 (E) 40	3179 (E) LED WATER PROOF DUAL VOLTAGE 39
3144 74	3164 (E) LED WATER PROOF DUAL VOLTAGE 42	3180 (E) LED WATER PROOF DUAL VOLTAGE 40
3145 (E) 35	3164 (E) LED DUAL VOLTAGE 43	3181 (E) LED WATER PROOF DUAL VOLTAGE 63
3146 (E) 68	3165 (E) LED DUAL VOLTAGE 19	3182 (E) LED WATER PROOF DUAL VOLTAGE 54/55
3147 (E) 68	3166 (E) 46	3185 (E) NEW PRODUCT 37
3148 (E) 61	3167 (E) LED DUAL VOLTAGE 49	3186 (E) LED WATER PROOF 64
3149 (E) LED DUAL VOLTAGE 30/31	3168 (E) LED WATER PROOF DUAL VOLTAGE 62	3187 (E) LED WATER PROOF DUAL VOLTAGE 87
3150 (E) 32/33	3168 (E) LED DUAL VOLTAGE 70	3188 (E) LED WATER PROOF DUAL VOLTAGE NEW PRODUCT 41
3152 (E) 44	3168 (E) LED WATER PROOF DUAL VOLTAGE 79	3189 (E) LED WATER PROOF DUAL VOLTAGE NEW PRODUCT 87
3155 (E) 13	3169 (E) 27	3190 (E) LED NEW PRODUCT 08/09

	3191	NEWPRODUCT LED 12/24 VOLTAGE	75		3216		93		4205	E		95
	3192	NEWPRODUCT E LED 12/24 VOLTAGE	20/21		3217	E	93		4206	E		98
	3193	E LED 12/24 VOLTAGE	22/23		3218		92		4207			101
	3194	E LED WATER PROOF 12/24 VOLTAGE	65		3220		92		4208			100
	3195	NEWPRODUCT E LED 12/24 VOLTAGE	38		3223		97		4209	E		99
	3197	NEWPRODUCT E LED	29		3224	E	97		4210	E		95
	3199	NEWPRODUCT E LED WATER PROOF 12/24 VOLTAGE	69		3225	E	90		4211	LED 12/24 VOLTAGE		95
	3201	E	94		3226	E	90		4212	NEWPRODUCT LED WATER PROOF 12/24 VOLTAGE		95
	3205	E	94		3227	E LED	88	Cablagens Cables Faisceau				07
	3206		94		3228	E LED	89	Barras de sinalização Rear lighting bars Plaque de signalisation				07
	3208		94		3229	E LED	91	Embalagem Packing Emballage				105-106
	3210	E	91		4192		86	Lâmpadas Bulbs Ampoules				104
	3211	E	91		4193		86	Telas retroreflectoras Retro-reflective markings Marqueurs rétro-réfléchissants				84
	3212		92		4201	E	102/103	Suportes vários para aplicação Different support to apply Différents supports pour application				07 86
	3213	E	93		4202		97					
	3214		96		4203		97					
	3215		93		4204		96					

Instalações completas para todo o tipo de carroçarias
 Complete wiring sets for all types of trailers and semi-trailers
 Kits électriques complètes pour tous les types de carrosseries

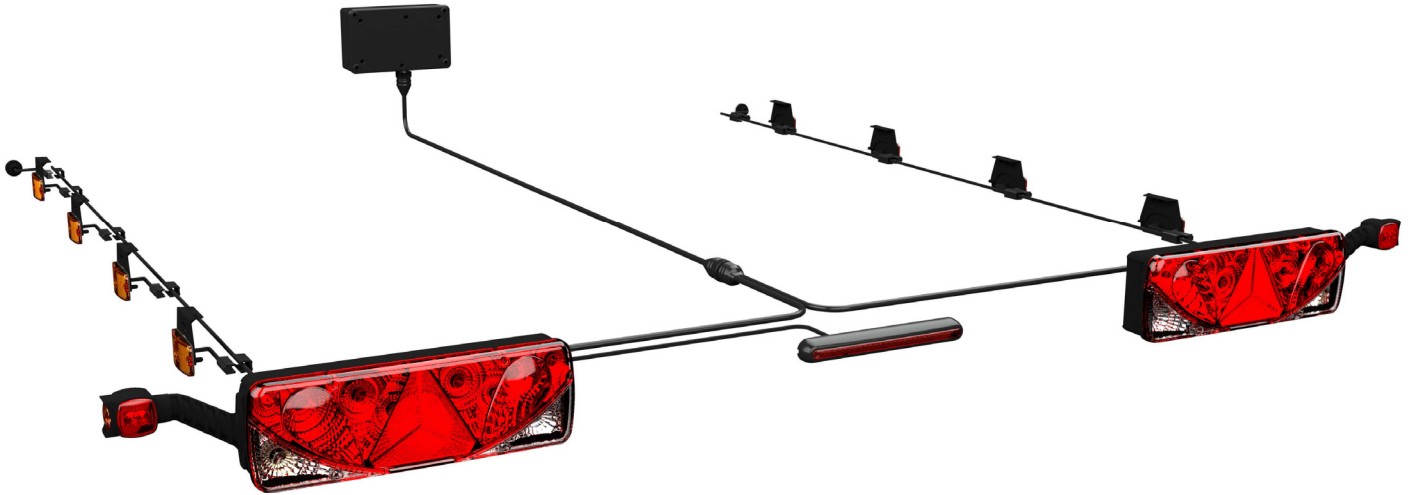

Barras de sinalização em PVC
 PVC rear lighting bars
 Plaque de signalisation pour remorque

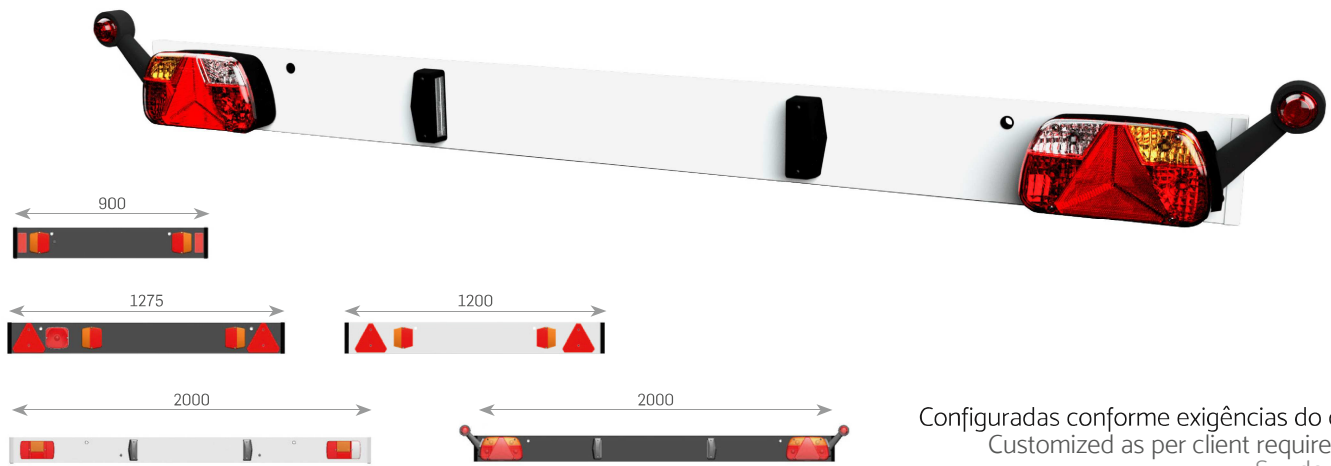

Configuradas conforme exigências do cliente
 Customized as per client requirements
 Sur demande



Junction box
 5101.0000000



Front box
 5110.0032000



15 Pins Coil Plug
 Max. length: 3m
 4.37.05.91.001



7 Pins Coil Plug
 White
 Max. length: 3m
 4.37.05.91.003



7 Pins Coil Plug
 Black
 Max. length: 3m
 4.37.05.91.002



1.399.01.0111

1.399.01.0011

3190

Refletor redondo
Round reflex reflector
Catadioptré rond

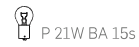

NEWPRODUCT

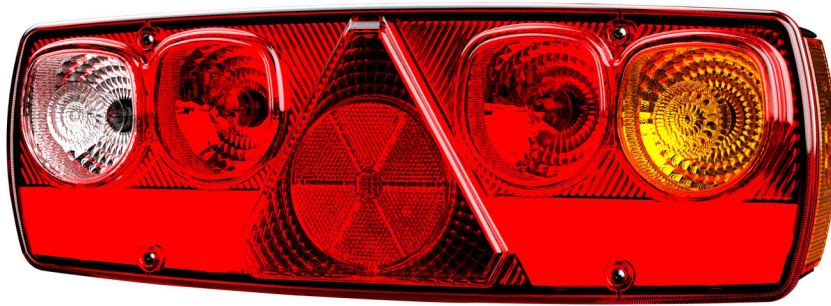

Referência Part N° Référence	Esquerdo Left Gauche	Direito Right Droit	Iluminação Chapa Matricula Registration Plate Light Éclairage de Plaque	Luz de Posição Lateral Side-Marker Lamp Feu de Position Lateral	Delimitador Lâmpada End Outline Bulb Feu de Gabarit Ampoule	Delimitador LED End Outline LED Feu de Gabarit LED	Sem Luz Posição Lateral Ou Delimitador Without Side-Marker Or End Outline Sans Feu de position Lateral Feu De Gabarit
3190.X0004Y0	•						
3190.X0005Y0	•		•	Y = 5	Y = 7	Y = 8	Y = 0
3190.X0006Y0		•					
3190.X0007Y0		•	•				

Peças de Reposição
Spare parts
Pièces de rechange

Vidro • Lens • Cabochon	3190.0000010
Delimitador lâmpada esquerdo 24V • LH end outline bulb 24V • Feu de gabarit ampoule gauche 24V	3170.0001004
Delimitador lâmpada direito 24V • RH end outline bulb 24V • Feu de gabarit ampoule droit 24V	3170.0001104
Delimitador LED esquerdo • LH end outline LED • Feu de gabarit LED gauche	3174.0001000
Delimitador LED direito • RH end outline LED • Feu de gabarit LED droit	3174.0001100

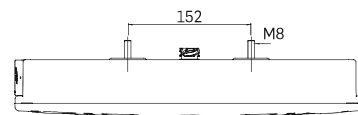
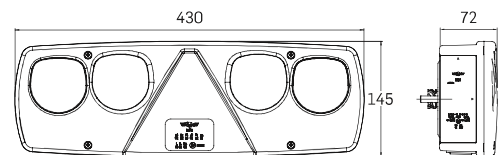

Conexão
Plug
Connection



X = 1
Compatível com MAN
Compatible with MAN
Compatible avec MAN



X = 2
Conetor DIN posterior
Back DIN plug
Connecteur DIN postérieur

Disponível com conetores de derivação
Available with junction plug
Disponible avec fiche de derivation



X = 4
Universal com rosca
Universal w/ cable entry nut plug
Universel avec presse-étoupe



X = 7
Conetor 7T
7T plug
Connecteur 7T



X = 8
Compatível com DAF
Compatible with DAF
Compatible avec DAF

Exemplo: X = 2, Y = 8

3190.2000780

Farolim direito com iluminação de chapa de matrícula, conetor DIN posterior e delimitador LED
RH lamp with registration plate light, back DIN plug and end outline LED
Feu arrière droit avec éclairage de plaque, connecteur DIN postérieur et feu de gabarit LED

P 21W BA 15s
 R 10W BA 15s



Refletor triangular
 Triangular reflex reflector
 Catadioptré triangulaire

3190

NEWPRODUCT



Referência Part N° Référence	Esquerdo Left Gauche	Direito Right Droit	Iluminação Chapa Matricula Registration Plate Light Éclairage de Plaque	Luz de Posição Lateral Side-Marker Lamp Feu de Position Lateral	Delimitador Lâmpada End Outline Bulb Feu de Gabarit Ampoule	Delimitador LED End Outline LED Feu de Gabarit LED	Sem Luz Posição Lateral Ou Delimitador Without Side-Marker Or End Outline Sans Feu de position Lateral Feu De Gabarit
3190.X0000Y0	•						
3190.X0001Y0	•		•	Y = 5	Y = 7	Y = 8	Y = 0
3190.X0002Y0		•					
3190.X0003Y0		•	•				

Peças de Reposição
 Spare parts
 Pièces de rechange

Vidro • Lens • Cabochon	3190.0000010
Delimitador lâmpada esquerdo 24V • LH end outline bulb 24V • Feu de gabarit ampoule gauche 24V	3170.0001004
Delimitador lâmpada direito 24V • RH end outline bulb 24V • Feu de gabarit ampoule droit 24V	3170.0001104
Delimitador LED esquerdo • LH end outline LED • Feu de gabarit LED gauche	3174.0001000
Delimitador LED direito • RH end outline LED • Feu de gabarit LED droit	3174.0001100

Conexão
 Plug
 Connection



X = 1
 Compatível com MAN
 Compatible with MAN
 Compatible avec MAN



X = 2
 Conetor DIN posterior
 Back DIN plug
 Connecteur DIN postérieur



X = 4
 Universal com rosca
 Universal w/ cable entry nut plug
 Universel avec presse-étoupe



X = 7
 Conetor 7T
 7T plug
 Connecteur 7T



X = 8
 Compatível com DAF
 Compatible with DAF
 Compatible avec DAF

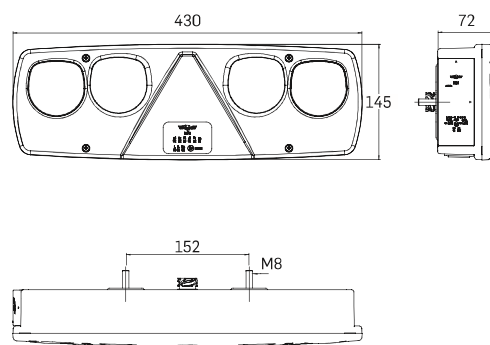

Disponível com conetores de derivação
 Available with junction plug
 Disponible avec fiche de derivation

Example: X = 2, Y = 8

3190.2000380

Farolim direito com iluminação de chapa de matrícula, conetor DIN posterior e delimitador LED
 RH lamp with registration plate light, back DIN plug and end outline LED
 Feu arrière droit avec éclairage de plaque, connecteur DIN postérieur et feu de gabarit LED

3175

Refletor redondo
Round reflex reflector
Catadioptre rond



P 21/5W BAY 15d



P 21W BA 15s



PY 21W BAU 15s



R 10W BA 15s



Referência Part N° Référence	Esquerdo Left Gauche	Direito Right Droit	Iluminação Chapa Matricula Registration Plate Light Éclairage de Plaque	Luz de Posição Lateral Side-Marker Lamp Feu de Position Lateral	Delimitador Lâmpada End Outline Bulb Feu de Gabarit Ampoule	Delimitador LED End Outline LED Feu de Gabarit LED	Sem Luz Posição Lateral Ou Delimitador Without Side-Marker Or End Outline Sans Feu de position Lateral Feu De Gabarit
3175.X0004Y0	•						
3175.X0005Y0	•		•	Y = 5	Y = 7	Y = 8	Y = 0
3175.X0006Y0		•					
3175.X0007Y0		•	•				

Peças de Reposição
Spare parts
Pièces de rechange

Vidro • Lens • Cabochon	3175.0000010
Delimitador lâmpada esquerdo 24V • LH end outline bulb 24V • Feu de gabarit ampoule gauche 24V	3170.0001004
Delimitador lâmpada direito 24V • RH end outline bulb 24V • Feu de gabarit ampoule droit 24V	3170.0001104
Delimitador LED esquerdo • LH end outline LED • Feu de gabarit LED gauche	3174.0001000
Delimitador LED direito • RH end outline LED • Feu de gabarit LED droit	3174.0001100

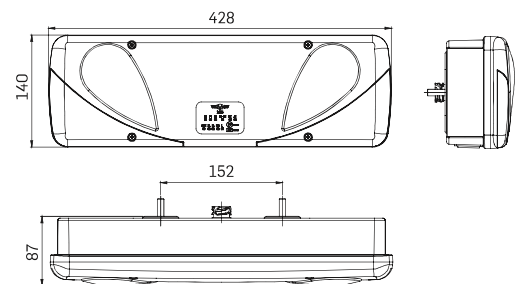

Conexão
Plug
Connection



X = 1
Compatível com MAN
Compatible with MAN
Compatible avec MAN



X = 2
Conetor DIN posterior
Back DIN plug
Connecteur DIN postérieur



X = 4
Universal com rosca
Universal w/ cable entry nut plug
Universel avec presse-étoupe



X = 7
Conetor 7T
7T plug
Connecteur 7T



X = 8
Compatível com DAF
Compatible with DAF
Compatible avec DAF

Disponível com conetores de derivação
Available with junction plug
Disponible avec fiche de derivation

Example: X = 4, Y = 0

3175.4000700

Farolim direito com iluminação de chapa de matrícula e conetor universal com rosca
RH lamp with registration plate light and plug universal with cable entry nut
Feu arrière droit avec éclairage de plaque et connecteur universel avec presse-étoupe

P 21/5W BAY 15d
 P 21W BA 15s
 PY 21W BAU 15s
 R 10W BA 15s



Refletor triangular
 Triangular reflex reflector
 Catadioptré triangulaire

3175



Referência Part N° Référence	Esquerdo Left Gauche	Direito Right Droit	Iluminação Chapa Matrícula Registration Plate Light Éclairage de Plaque	Luz de Posição Lateral Side-Marker Lamp Feu de Position Lateral	Delimitador Lâmpada End Outline Bulb Feu de Gabarit Ampoule	Delimitador LED End Outline LED Feu de Gabarit LED	Sem Luz Posição Lateral Ou Delimitador Without Side-Marker Or End Outline Sans Feu de position Lateral Feu De Gabarit
3175.X0000Y0	•						
3175.X0001Y0	•		•	Y = 5	Y = 7	Y = 8	Y = 0
3175.X0002Y0		•					
3175.X0003Y0		•	•				

Peças de Reposição
 Spare parts
 Pièces de rechange

Vidro • Lens • Cabochon	3175.0000010
Delimitador lâmpada esquerdo 24V • LH end outline bulb 24V • Feu de gabarit ampoule gauche 24V	3170.0001004
Delimitador lâmpada direito 24V • RH end outline bulb 24V • Feu de gabarit ampoule droit 24V	3170.0001104
Delimitador LED esquerdo • LH end outline LED • Feu de gabarit LED gauche	3174.0001000
Delimitador LED direito • RH end outline LED • Feu de gabarit LED droit	3174.0001100

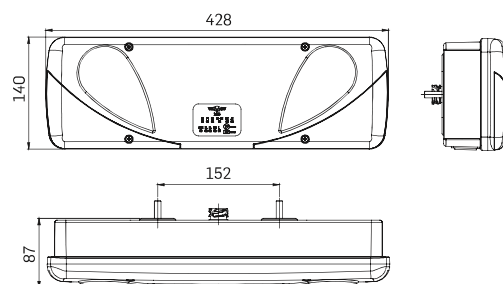

Disponível com conetores de derivação
 Available with junction plug
 Disponible avec fiche de dérivation

Conexão
 Plug
 Connection



X = 1
 Compatível com MAN
 Compatible with MAN
 Compatible avec MAN



X = 2
 Conetor DIN posterior
 Back DIN plug
 Connecteur DIN postérieur



X = 4
 Universal com rosca
 Universal w/ cable entry nut plug
 Universel avec presse-étoupe



X = 7
 Conetor 7T
 7T plug
 Connecteur 7T



X = 8
 Compatível com DAF
 Compatible with DAF
 Compatible avec DAF

Example: X = 4, Y = 0

3175.4000300

Farolim direito com iluminação de chapa de matrícula e conetor universal com rosca
 RH lamp with registration plate light and plug universal with cable entry nut
 Feu arrière droit avec éclairage de plaque et connecteur universel avec presse-étoupe

3163



P 21W BA 15s
 R 5W BA 15s
 R 10W BA 15s



Referência Part N° Référence	Esquerdo Left Gauche	Direito Right Droit	Iluminação Chapa Matrícula Registration Plate Light Éclairage de Plaque	Luz de Posição Lateral Side-Marker Lamp Feu de Position Lateral	Refletor Triangular Triangular Reflex Reflector Catadioptré Triangulaire	Refletor Retangular Rectangular Reflex Reflector Catadioptré Rectangulaire
3163.X000150	•		•	•	•	
3163.X000250		•	•	•	•	
3163.X000350	•		•	•		•
3163.X000550		•	•	•		•

Peças de Reposição
Spare parts
Pièces de rechange

Refletor triangular Triangular Reflex Reflector Catadioptré Triangulaire	Vidro esquerdo • Left Lens • Cabochon Gauche	3163.0000110
	Vidro direito • Right Lens • Cabochon Droit	3163.0000210
Refletor retangular Rectangular Reflex Reflector Catadioptré Rectangulaire	Vidro • Lens • Droit	3163.0000310

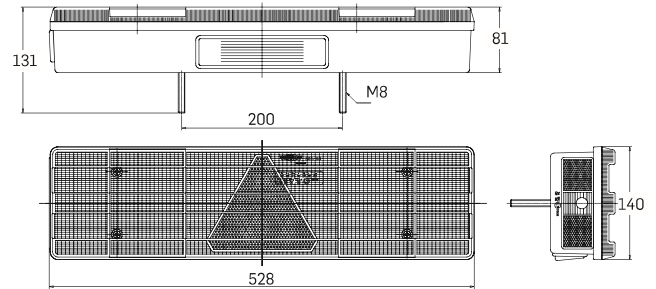

Conexão
Plug
Connection



X = 2
Conetor DIN posterior
Back DIN plug
Connecteur DIN postérieur



X = 3
Conetor DIN lateral
Side DIN plug
Connecteur DIN latérale



X = 4
Universal com rosca
Universal w/ cable entry nut plug
Universel avec presse-étoupe

Example: X = 3
3163.3000250

Farolim direito com Refletor triangular, iluminação de chapa de matrícula, luz de posição lateral e conetor DIN lateral
RH lamp with triangular reflex reflector, registration plate light, side-marker lamp and side DIN plug
Feu arrière droit avec catadioptré triangulaire, éclairage de plaque, feu de position lateral et connecteur DIN latérale

P 21W BA 15s
 R 5W BA 15s



3155



Referência Part N° Référence	Esquerdo Left Gauche	Direito Right Droit	Iluminação Chapa Matricula Registration Plate Light Éclairage de Plaque	Luz de Posição Lateral Side-Marker Lamp Feu de Position Lateral	Fixação Fitting Fixation
3155.X000050	•		•	•	A
3155.X000060	•		•	•	B
3155.X000250		•	•	•	A
3155.X000260		•	•	•	B
3155.X000550	•		•	•	C
3155.X000750		•	•	•	C

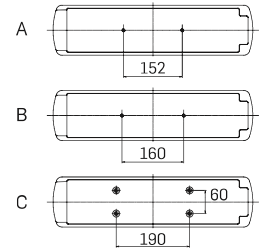

Peças de Reposição
 Spare parts
 Pièces de rechange

Vidro • Lens • Cabochon 3155.0000010

Conexão
 Plug
 Connection



X = 1
 Furação lateral inferior
 Hole down side
 Trou côle inférieur



X = 2
 Conector DIN posterior
 Back DIN plug
 Connecteur DIN postérieur



X = 4
 Universal com rosca
 Universal w/ cable entry nut plug
 Universel avec presse-étoupe



X = 0
 Compatível com VOLVO
 Compatible with VOLVO
 Compatible avec VOLVO



X = 8
 Compatível com SCANIA R
 Compatible with SCANIA R
 Compatible avec SCANIA R

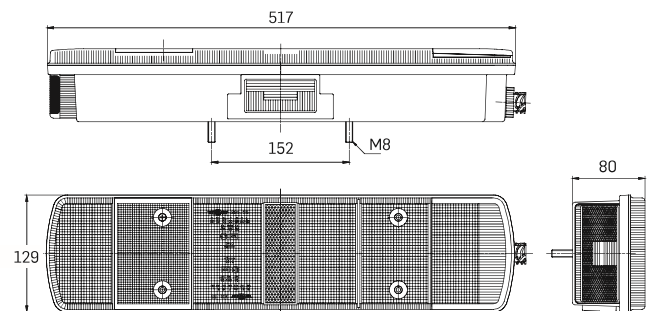
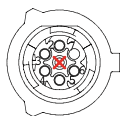

Example: **X = 0**
 3155.0000250

Farolim direito com iluminação de chapa de matrícula, luz de posição lateral e conector compatível com VOLVO - fixação 152mm
 RH lamp with registration plate light, side-marker lamp and plug compible with VOLVO - fitting 152mm
 Feu arrière droit avec éclairage de plaque, feu de position lateral et connecteur compatible avec VOLVO - fixation 152mm

3138

Refletor retangular
Rectangular reflex reflector
Catadioptre rectangulaire



P 21W BA 15s

R 5W BA 15s

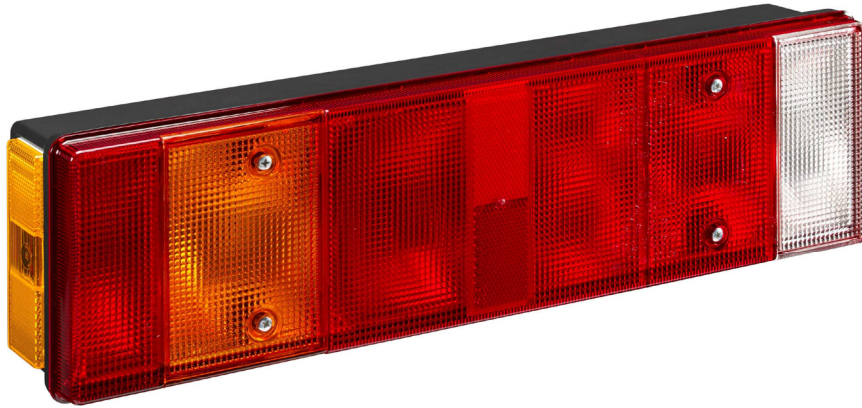

Referência Part N° Référence	Esquerdo Left Gauche	Direito Right Droit	Iluminação Chapa Matrícula Registration Plate Light Éclairage de Plaque	Luz de Posição Lateral Side-Marker Lamp Feu de Position Lateral
3138.X000300	•		•	
3138.X000350	•		•	•
3138.X000400	•			
3138.X000450	•			•
3138.X000500		•	•	
3138.X000550		•	•	•
3138.X000600		•		
3138.X000650		•		•

Peças de Reposição
Spare parts
Pièces de rechange

Vidro • Lens • Cabochon 3138.0000010

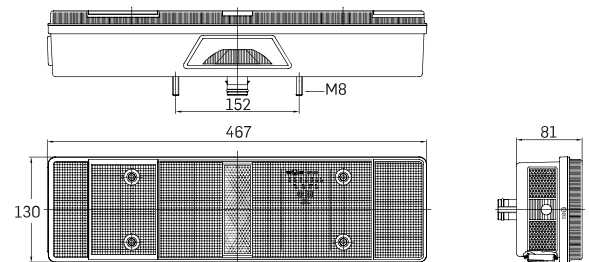

Conexão
Plug
Connection



X = 0
Compatível com IVECO
Compatible with IVECO
Compatible avec IVECO



X = 1
Compatível com MAN
Compatible with MAN
Compatible avec MAN



X = 2
Conetor DIN posterior
Back DIN plug
Connecteur DIN postérieur



X = 3
Conetor DIN lateral
Side DIN plug
Connecteur DIN latérale



X = 4
Universal com rosca
Universal w/ cable entry nut plug
Universel avec presse-étoupe



X = 8
Compatível com DAF
Compatible with DAF
Compatible avec DAF

Example: X = 1
3138.1000550

Farolim direito com iluminação de chapa de matrícula, luz de posição lateral e conetor compatível com MAN
RH lamp with registration plate light, side-marker lamp and plug compatible with MAN
Feu arrière droit avec éclairage de plaque, feu de position latéral et connecteur compatible avec MAN

P 21W BA 15s
 R 5W BA 15s



Refletor triangular
 Triangular reflex reflector
 Catadioptré triangulaire

3138



Referência Part N° Référence	Esquerdo Left Gauche	Direito Right Droit	Iluminação Chapa Matrícula Registration Plate Light Éclairage de Plaque	Luz de Posição Lateral Side-Marker Lamp Feu de Position Latéral
3138.X000150	•		•	•
3138.X000250		•	•	•

Peças de Reposição
 Spare parts
 Pièces de rechange

Vidro esquerdo • Left lens • Caboçon gauche	3138.0000110
Vidro direito • Right lens • Caboçon droit	3138.0000210

Conexão
 Plug
 Connection



X = 0
 Compatível com IVECO
 Compatible with IVECO
 Compatible avec IVECO



X = 1
 Compatível com MAN
 Compatible with MAN
 Compatible avec MAN



X = 2
 Conetor DIN posterior
 Back DIN plug
 Connecteur DIN postérieur



X = 3
 Conetor DIN lateral
 Side DIN plug
 Connecteur DIN latérale



X = 4
 Universal com rosca
 Universal w/ cable entry nut plug
 Universel avec presse-étoupe



X = 8
 Compatível com DAF
 Compatible with DAF
 Compatible avec DAF

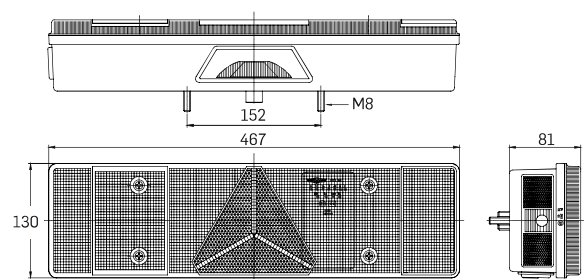

Example: **X = 1**
 3138.1000250

Farolim direito com iluminação de chapa de matrícula, luz de posição lateral e conetor compatível com MAN
 RH lamp with registration plate light, side-marker lamp and plug compatible with MAN
 Feu arrière droit avec éclairage de plaque, feu de position latéral et connecteur compatible avec MAN

3161





Referência Part N° Référence	Esquerdo Left Gauche	Direito Right Droit	Iluminação Chapa Matricula Registration Plate Light Éclairage de Plaque	Luz de Posição Lateral Side-Marker Lamp Feu de Position Lateral
3161.X000300	•		•	
3161.X000350	•		•	•
3161.X000400	•			
3161.X000450	•			•
3161.X000500		•	•	
3161.X000550		•	•	•
3161.X000600		•		
3161.X000650		•		•

Peças de Reposição
Spare parts
Pièces de rechange

Vidro • Lens • Cabochon

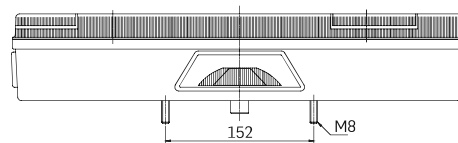
3161.0000310



Conexão
Plug
Connection



X = 0
Compatível com IVECO
Compatible with IVECO
Compatible avec IVECO



X = 1
Compatível com MAN
Compatible with MAN
Compatible avec MAN

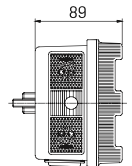
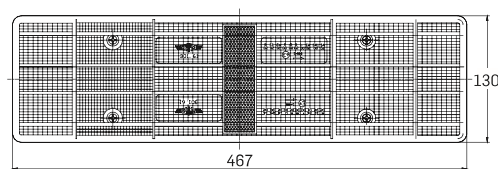

X = 2
Conetor DIN posterior
Back DIN plug
Connecteur DIN postérieur



X = 3
Conetor DIN lateral
Side DIN plug
Connecteur DIN latérale



X = 4
Universal com rosca
Universal w/ cable entry nut plug
Universel avec presse-étoupe

Exemplo: X = 1

3161.1000550

Farolim direito com iluminação de chapa de matrícula, luz de posição lateral e conetor compatível com MAN
RH lamp with registration plate light, side-marker lamp and plug compatible with MAN
Feu arrière droit avec éclairage de plaque, feu de position latéral et connecteur compatible avec MAN

P 21W BA 15s
 R 5W BA 15s



3162



Referência Part N° Référence	Esquerdo Left Gauche	Direito Right Droit	Iluminação Chapa Matrícula Registration Plate Light Éclairage de Plaque	Luz de Nevoeiro Fog Light Feu Anti-Brouillard	Luz de Marcha Atrás Reversing Light Feu de Recul
3162.X000000		•	•		•
3162.X000060		•			•
3162.X000100		•	•	•	
3162.X000160		•		•	
3162.X000200	•		•		•
3162.X000260	•				•
3162.X000300	•		•	•	
3162.X000360	•			•	

Peças de Reposição
 Spare parts
 Pièces de rechange

Vidro com marcha atrás • Lens with reversing light • Cabochon avec feu de recul 3162.0000010
 Vidro com nevoeiro • Lens with fog light • Cabochon avec feu anti-brouillard 3162.0000110

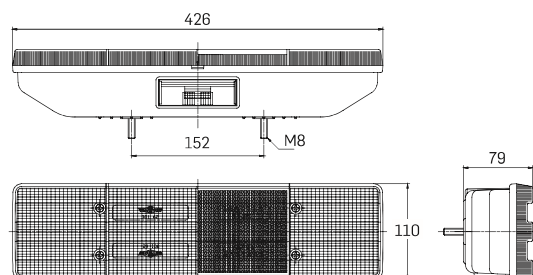

Conexão
 Plug
 Connection



X = 7
 Conetor original
 Original plug
 Connecteur original



X = 4
 Universal com rosca
 Universal w/ cable entry nut plug
 Universel avec presse-étoupe

Example: X = 4
 3162.4000300

Farolim esquerdo com nevoeiro, com iluminação de chapa de matrícula e conetor universal com rosca
 LH lamp with Fog Light, registration plate light and plug universal with cable entry nut
 Feu arrière gauche avec anti-brouillard, éclairage de plaque et connecteur DIN Postérieur Universel avec presse-étoupe

3117



P 21W BA 15s R 5W BA 15s



Referência Part N° Référence	Esquerdo Left Gauche	Direito Right Droit	Iluminação Chapa Matrícula Registration Plate Light Éclairage de Plaque	Luz de Posição Lateral Side-Marker Lamp Feu de Position Latéral
3117.X000000	•		•	
3117.X000050	•		•	•
3117.X000700	•			
3117.X000750	•			•
3117.X000800		•	•	
3117.X000850		•	•	•
3117.X000900		•		
3117.X000950		•		•

Peças de Reposição
Spare parts
Pièces de rechange

Vidro • Lens • Cabochon	7.3117.0000010
Vidro com vedantes • Lens with gasket • Cabochon avec joint	7.3117.0000028
Vidro com vedantes e parafusos • Lens with gasket and screws • Cabochon avec joint et vis	1.3117.0000028

Conexão
Plug
Connection



X = 0
Compatível com VOLVO
Compatible with VOLVO
Compatible avec VOLVO



X = 1
Universal com cabos
Universal with cables
Universel avec cable



X = 2
Universal sem cabos
Universal without cables
Universel sans cable

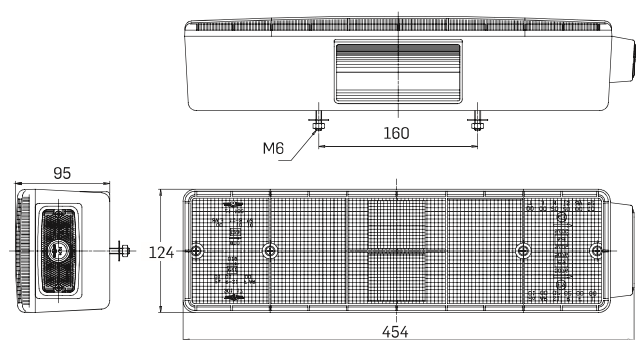

Example: X = 1
3117.1000050

Farolim esquerdo com iluminação de chapa de matrícula, luz de posição lateral e conexão universal com cabos
LH lamp with registration plate light, side-marker lamp and universal plug with cable
Feu arrière gauche avec éclairage de plaque, feu de position latéral et connection universel avec câbles

PTOTAL
9,6W - 12V
12W - 24V



3165



(64)



(11)

Referência Part N° Référence	Esquerdo Left Gauche	Direito Right Droit	Pres/STOP Pos/STOP Pos/STOP	Pisca Side-indicator Clignotant	Luz Nevoeiro Fog Light Feu Anti-brouillard	Marcha Atrás Reversing Light Feu de Recul	OFF OFF OFF	ON ON ON
3165.11X0000	•		•	•		•		
3165.11X0400	•		•	•	•	•		
3165.11X0500	•		•	•	•			
3165.11X2000		•	•	•		•		
3165.11X2400		•	•	•	•	•		
3165.11X2500		•	•	•	•			
3165.11X4000			•	•		•		
3165.11X4400			•	•	•	•		
3165.11X4500			•	•	•			
3165.64X0000	•		•	•		•		
3165.64X0400	•		•	•	•	•		
3165.64X0500	•		•	•	•			
3165.64X2000		•	•	•		•		
3165.64X2400		•	•	•	•	•		
3165.64X2500		•	•	•	•			
3165.64X4000			•	•		•		
3165.64X4400			•	•	•	•		
3165.64X4500			•	•	•			

Conexão
Plug
Connection



X = 2
Conetor DIN posterior
Back DIN plug
Connecteur DIN postérieur



X = 4
Universal com rosca
Universal w/ cable entry nut plug
Universel avec presse-étoupe



X = 5
Conetor de 5 pinos*
5 pins connector*
Connecteur à 5 broches*

*Sem luz de nevoeiro ou sem luz de marcha atrás
*Without fog light or without reversing light
*Sans feu anti-brouillard ou sans feu de recul.

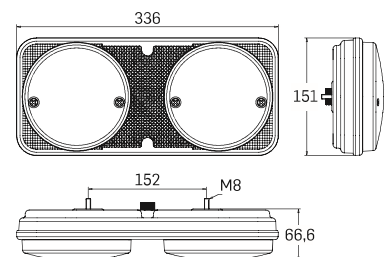

3192

Refletor redondo
Round reflex reflector
Catadioptrre rond



PTOTAL
5W - 12V
9W - 24V

NEWPRODUCT

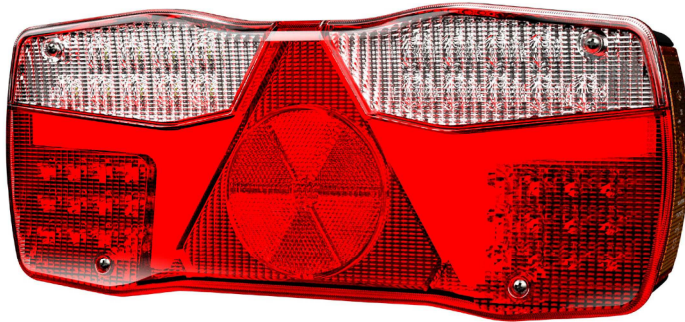

Referência Part N° Référence	Esquerdo Left Gauche	Direito Right Droit	Iluminação Chapa Matricula Registration Plate Light Éclairage de Plaque	Luz de Posição Lateral Side-Marker Lamp Feu de Position Lateral	Delimitador Lâmpada End Outline Bulb Feu de Gabarit Ampoule	Delimitador LED End Outline LED Feu de Gabarit LED	Sem Luz Posição Lateral Ou Delimitador Without Side-Marker Or End Outline Sans Feu de position Lateral Feu De Gabarit
3192.X0004Y0	•						
3192.X0005Y0	•		•	Y = 5	Y = 7	Y = 8	Y = 0
3192.X0006Y0		•					
3192.X0007Y0		•	•				

Peças de Reposição
Spare parts
Pièces de rechange

Vidro • Lens • Cabochon	3192.0000010
Delimitador lâmpada esquerdo 24V • LH end outline bulb 24V • Feu de gabarit ampoule gauche 24V	3170.0001004
Delimitador lâmpada direito 24V • RH end outline bulb 24V • Feu de gabarit ampoule droit 24V	3170.0001104
Delimitador LED esquerdo • LH end outline LED • Feu de gabarit LED gauche	3174.0001000
Delimitador LED direito • RH end outline LED • Feu de gabarit LED droit	3174.0001100

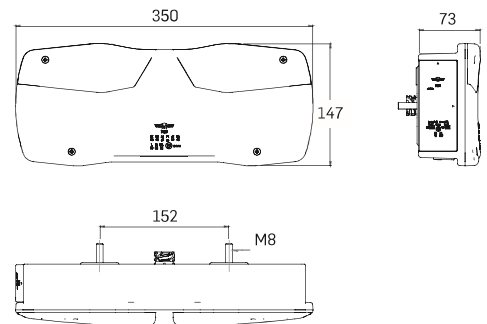

Conexão
Plug
Connection

	X = 1 Compatível com MAN Compatible with MAN Compatible avec MAN		X = 2 Conetor DIN posterior Back DIN plug Connecteur DIN postérieur		X = 4 Universal com rosca Universal w/ cable entry nut plug Universel avec presse-étoupe		X = 8 Compatível com DAF Compatible with DAF Compatible avec DAF
--	---	--	--	--	---	--	---

Example: X = 2, Y = 8

3192.2000780

Farolim direito com iluminação de chapa de matrícula, conetor DIN posterior e delimitador LED
RH lamp with registration plate light, back DIN plug and end outline LED
Feu arrière droit avec éclairage de plaque, connecteur DIN postérieur et feu de gabarit LED

PTOTAL
5W - 12V
9W - 24V



Refletor triangular
Triangular reflex reflector
Catadioptré triangulaire

3192

NEWPRODUCT

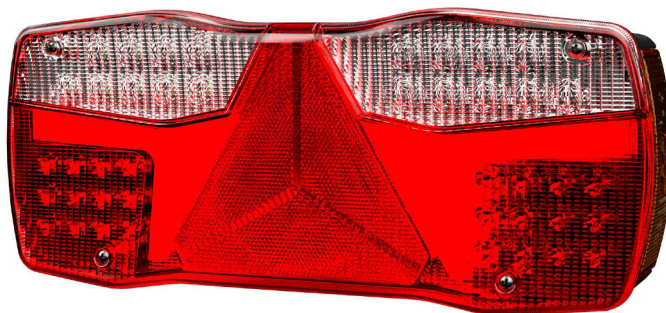

Referência Part N° Référence	Esquerdo Left Gauche	Direito Right Droit	Iluminação Chapa Matricula Registration Plate Light Éclairage de Plaque	Luz de Posição Lateral Side-Marker Lamp Feu de Position Lateral	Delimitador Lâmpada End Outline Bulb Feu de Gabarit Ampoule	Delimitador LED End Outline LED Feu de Gabarit LED	Sem Luz Posição Lateral Ou Delimitador Without Side-Marker Or End Outline Sans Feu de position Lateral Feu De Gabarit
3192.X0000Y0	•						
3192.X0001Y0	•		•	Y = 5	Y = 7	Y = 8	Y = 0
3192.X0002Y0		•					
3192.X0003Y0		•	•				

Peças de Reposição
Spare parts
Pièces de rechange

Vidro • Lens • Cabochon	3192.0000010
Delimitador lâmpada esquerdo 24V • LH end outline bulb 24V • Feu de gabarit ampoule gauche 24V	3170.0001004
Delimitador lâmpada direito 24V • RH end outline bulb 24V • Feu de gabarit ampoule droit 24V	3170.0001104
Delimitador LED esquerdo • LH end outline LED • Feu de gabarit LED gauche	3174.0001000
Delimitador LED direito • RH end outline LED • Feu de gabarit LED droit	3174.0001100

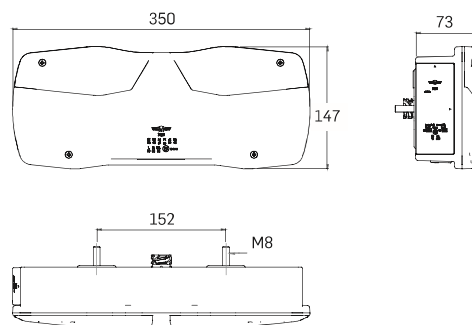

Conexão
Plug
Connection



X = 1
Compatível com MAN
Compatible with MAN
Compatible avec MAN



X = 2
Conetor DIN posterior
Back DIN plug
Connecteur DIN postérieur



X = 4
Universal com rosca
Universal w/ cable entry nut plug
Universel avec presse-étoupe



X = 8
Compatível com DAF
Compatible with DAF
Compatible avec DAF

Example: X = 2, Y = 8

3192.2000380

Farolim direito com iluminação de chapa de matrícula, conetor DIN posterior e delimitador LED
RH lamp with registration plate light, back DIN plug and end outline LED
Feu arrière droit avec éclairage de plaque, connecteur DIN postérieur et feu de gabarit LED

3193

Refletor redondo
Round reflex reflector
Catadioptre rond



Presença LED
Position LED
Veilleuse LED



Referência Part N° Référence	Esquerdo Left Gauche	Direito Right Droit	Iluminação Chapa Matricular Registration Plate Light Éclairage de Plaque	STOP LED STOP LED STOP LED	Luz de Posição Lateral Side-Marker Lamp Feu de Position Lateral	Delimitador Lâmpada End Outline Bulb Feu de Gabarit Ampoule	Delimitador LED End Outline LED Feu de Gabarit LED	Sem Luz Posição Lateral Ou Delimitador Without Side-Marker Or End Outline Sans Feu de position Lateral Feu De Gabarit
------------------------------------	----------------------------	---------------------------	--	----------------------------------	---	---	--	---

3193.X0004Y0	•							
3193.X0024Y0	•			•				
3193.X0005Y0	•		•					
3193.X0025Y0	•		•	•				
3193.X0006Y0		•			Y = 5	Y = 7	Y = 8	Y = 0
3193.X0026Y0		•		•				
3193.X0007Y0		•	•					
3193.X0027Y0		•	•	•				

Peças de Reposição
Spare parts
Pièces de rechange

Vidro • Lens • Cabochon	3193.0000010
Delimitador lâmpada esquerdo 24V • LH end outline bulb 24V • Feu de gabarit ampoule gauche 24V	3170.0001004
Delimitador lâmpada direito 24V • RH end outline bulb 24V • Feu de gabarit ampoule droit 24V	3170.0001104
Delimitador LED esquerdo • LH end outline LED • Feu de gabarit LED gauche	3174.0001000
Delimitador LED direito • RH end outline LED • Feu de gabarit LED droit	3174.0001100

Disponível com conetores de derivação
Available with junction plug
Disponible avec fiche de dérivation

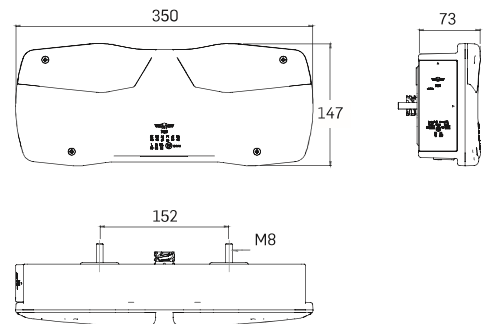

Conexão
Plug
Connection

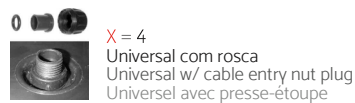

Exemplo: X = 2, Y = 8

3193.2000780

Farolim direito com iluminação de chapa de matrícula, conetor DIN posterior e delimitador LED
RH lamp with registration plate light, back DIN plug and end outline LED
Feu arrière droit avec éclairage de plaque, connecteur DIN postérieur et feu de gabarit LED

PY 21W BAU 15s
 P 21W BA 15s
 R 10W BA 15s



Refletor triangular
 Triangular reflex reflector
 Catadioptré triangulaire

3193



Presença LED
 Position LED
 Veilleuse LED

Referência Part N° Référence	Esquerdo Left Gauche	Direito Right Droit	Iluminação Chapa Matricula Registration Plate Light Éclairage de Plaque	STOP LED STOP LED STOP LED	Luz de Posição Lateral Side-Marker Lamp Feu de Position Lateral	Delimitador Lâmpada End Outline Bulb Feu de Gabarit Ampoule	Delimitador LED End Outline LED Feu de Gabarit LED	Sem Luz Posição Lateral Ou Delimitador Without Side-Marker Or End Outline Sans Feu de position Lateral Feu De Gabarit
------------------------------------	----------------------------	---------------------------	---	----------------------------------	---	---	--	---

3193.X0000Y0	•							
3193.X0020Y0	•			•				
3193.X0001Y0	•		•					
3193.X0021Y0	•		•	•				
3193.X0002Y0		•			Y = 5	Y = 7	Y = 8	Y = 0
3193.X0022Y0		•		•				
3193.X0003Y0		•	•					
3193.X0023Y0		•	•	•				

Peças de Reposição
 Spare parts
 Pièces de rechange

Vidro • Lens • Cabochon	3193.0000010
Delimitador lâmpada esquerdo 24V • LH end outline bulb 24V • Feu de gabarit ampoule gauche 24V	3170.0001004
Delimitador lâmpada direito 24V • RH end outline bulb 24V • Feu de gabarit ampoule droit 24V	3170.0001104
Delimitador LED esquerdo • LH end outline LED • Feu de gabarit LED gauche	3174.0001000
Delimitador LED direito • RH end outline LED • Feu de gabarit LED droit	3174.0001100

Disponível com conetores de derivação
 Available with junction plug
 Disponible avec fiche de derivation

Conexão
 Plug
 Connection

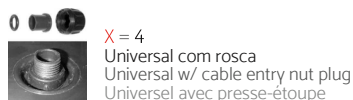
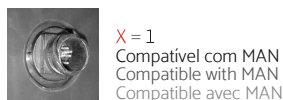
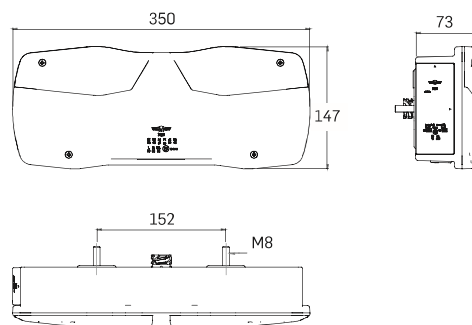

Example: X = 2, Y = 8

3193.2000380

Farolim direito com iluminação de chapa de matrícula, conetor DIN posterior e delimitador LED
 RH lamp with registration plate light, back DIN plug and end outline LED
 Feu arrière droit avec éclairage de plaque, connecteur DIN postérieur et feu de gabarit LED

3177

Refletor redondo
Round reflex reflector
Catadioptre rond

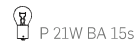

NEWPRODUCT



Referência Part N° Référence	Esquerdo Left Gauche	Direito Right Droit	Iluminação Chapa Matrícula Registration Plate Light Éclairage de Plaque	Luz de Posição Lateral Side-Marker Lamp Feu de Position Lateral	Delimitador Lâmpada End Outline Bulb Feu de Gabarit Ampoule	Delimitador LED End Outline LED Feu de Gabarit LED	Sem Luz Posição Lateral Ou Delimitador Without Side-Marker Or End Outline Sans Feu de position Lateral Feu De Gabarit
------------------------------------	----------------------------	---------------------------	---	---	---	--	---

3177.X0004Y0	•						
3177.X0005Y0	•		•	Y = 5	Y = 7	Y = 8	Y = 0
3177.X0006Y0		•					
3177.X0007Y0		•	•				

Peças de Reposição
Spare parts
Pièces de rechange

Vidro • Lens • Cabochon	3177.0000010
Delimitador lâmpada esquerdo 24V • LH end outline bulb 24V • Feu de gabarit ampoule gauche 24V	3170.0001004
Delimitador lâmpada direito 24V • RH end outline bulb 24V • Feu de gabarit ampoule droit 24V	3170.0001104
Delimitador LED esquerdo • LH end outline LED • Feu de gabarit LED gauche	3174.0001000
Delimitador LED direito • RH end outline LED • Feu de gabarit LED droit	3174.0001100

Disponível com conetores de derivação
Available with junction plug
Disponible avec fiche de derivation

Conexão
Plug
Connection

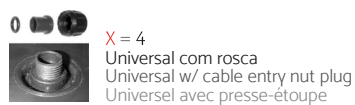
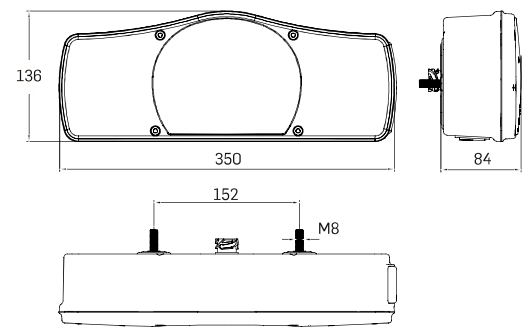

Example: X = 2, Y = 8

3177.2000780

Farolim direito com iluminação de chapa de matrícula, conetor DIN posterior e delimitador LED
RH lamp with registration plate light, back DIN plug and end outline LED
Feu arrière droit avec éclairage de plaque, connecteur DIN postérieur et feu de gabarit LED

PY 21W BAU 15s
 P 21W BA 15s
 R 10W BA 15s



Refletor triangular
 Triangular reflex reflector
 Catadioptré triangulaire

3177

NEWPRODUCT



Referência Part N° Référence	Esquerdo Left Gauche	Direito Right Droit	Iluminação Chapa Matrícula Registration Plate Light Éclairage de Plaque	Luz de Posição Lateral Side-Marker Lamp Feu de Position Lateral	Delimitador Lâmpada End Outline Bulb Feu de Gabarit Ampoule	Delimitador LED End Outline LED Feu de Gabarit LED	Sem Luz Posição Lateral Ou Delimitador Without Side-Marker Or End Outline Sans Feu de position Lateral Feu De Gabarit
------------------------------------	----------------------------	---------------------------	---	---	---	--	---

3177.X0000Y0	•						
3177.X0001Y0	•		•	Y = 5	Y = 7	Y = 8	Y = 0
3177.X0002Y0		•					
3177.X0003Y0		•	•				

Peças de Reposição
 Spare parts
 Pièces de rechange

Vidro • Lens • Cabochon	3177.0000010
Delimitador lâmpada esquerdo 24V • LH end outline bulb 24V • Feu de gabarit ampoule gauche 24V	3170.0001004
Delimitador lâmpada direito 24V • RH end outline bulb 24V • Feu de gabarit ampoule droit 24V	3170.0001104
Delimitador LED esquerdo • LH end outline LED • Feu de gabarit LED gauche	3174.0001000
Delimitador LED direito • RH end outline LED • Feu de gabarit LED droit	3174.0001100

Disponível com conetores de derivação
 Available with junction plug
 Disponible avec fiche de derivation

Conexão
 Plug
 Connection

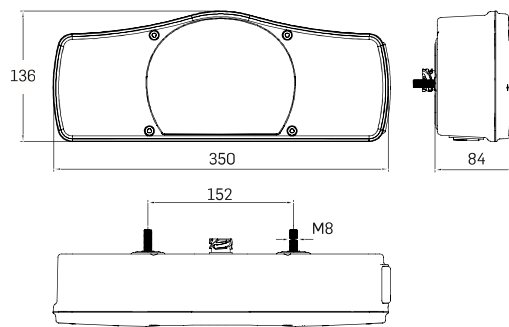

X = 2
 Conetor DIN posterior
 Back DIN plug
 Connecteur DIN postérieur

X = 4
 Universal com rosca
 Universal w/ cable entry nut plug
 Universel avec presse-étoupe

X = 7
 Conetor 7T
 7T plug
 Connecteur 7T

Example: X = 2, Y = 8

3177.2000380

Farolim direito com iluminação de chapa de matrícula, conetor DIN posterior e delimitador LED
 RH lamp with registration plate light, back DIN plug and end outline LED
 Feu arrière droit avec éclairage de plaque, connecteur DIN postérieur et feu de gabarit LED

3160



P 21W BA 15s R 10W BA 15s



Referência Part N° Référence	Esquerdo Left Gauche	Direito Right Droit	Iluminação Chapa Matricula Registration Plate Light Éclairage de Plaque	Luz de Posição Lateral Side-Marker Lamp Feu de Position Lateral	Homologação Horizontal/Vertical Horizontal/Vertical Mounting Approval Homologué Position Horizontal/Vertical
3160.X000000	•		•		H
3160.X000050	•		•	•	H
3160.X000100	•				H/V
3160.X000150	•			•	H
3160.X000200		•	•		H
3160.X000250		•	•	•	H
3160.X000300		•			H/V
3160.X000350		•		•	H
3160.X000450	•			•	V
3160.X000650		•		•	V

Peças de Reposição
Spare parts
Pièces de rechange

Vidro • Lens • Cabochon 3160.0000010

Conexão
Plug
Connection



X = 2
Conetor DIN posterior
Back DIN plug
Connecteur DIN postérieur



X = 4
Universal com rosca
Universal w/ cable entry nut plug
Universel avec presse-étoupe

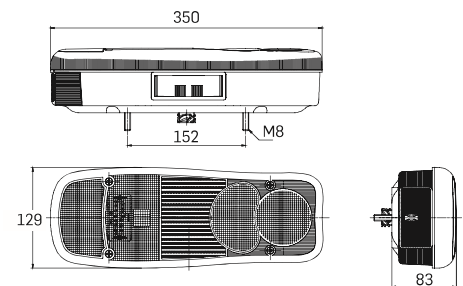

Example: X = 2
3160.2000250

Farolím direito com iluminação de chapa de matrícula, luz de posição lateral, conetor DIN posterior e homologação horizontal
RH lamp with registration plate light, side-marker lamp, back DIN plug and horizontal mounting approval
Feu arrière droit avec éclairage de plaque, feu de position latéral, connecteur DIN Postérieur et homologué position horizontal

P 21W BA 15s R 10W BA 15s



3169



Referência Part N° Référence	Esquerdo Left Gauche	Direito Right Droit	Iluminação Chapa Matricula Registration Plate Light Éclairage de Plaque	Luz de Posição Lateral Side-Marker Lamp Feu de Position Lateral	Refletor Triangular Triangular Reflex Reflector Catadioptrre Triangulaire	Homologação Horizontal/Vertical Horizontal/Vertical Mounting Approval Homologué Position Horizontal/Vertical
3169.X000000	•		•			H
3169.X000050	•		•	•		H
3169.X000100	•					H/V
3169.X000150	•			•		H
3169.X000200		•	•			H
3169.X000250		•	•	•		H
3169.X000300		•				H/V
3169.X000350		•		•		H
3169.X000450	•			•		V
3169.X000500	•		•		•	H
3169.X000550	•		•	•	•	H
3169.X000650		•		•		V
3169.X000700	•				•	H
3169.X000750	•			•	•	H
3169.X000800		•	•		•	H
3169.X000850		•	•	•	•	H
3169.X000900		•			•	H
3169.X000950		•		•	•	H

Peças de Reposição
Spare parts
Pièces de rechange

Vidro esquerdo, Refletor triangular • Left lens, triangular reflex reflector • Cabochon gauche, catadioptrre triangulaire 3169.0000710

Vidro direito, Refletor triangular • Right lens, triangular reflex reflector • Cabochon droit, catadioptrre triangulaire 3169.0000810

Vidro direito/esquerdo, Refletor retangular • Right/left lens, rectangular reflex reflector 3169.0000010 (H)
 Cabochon droit/gauche, catadioptrre rectangulaire 3169.0000610 (V)

Conexão
Plug
Connection



X = 2
Conetor DIN posterior
Back DIN plug
Connecteur DIN postérieur



X = 4
Universal com rosca
Universal w/ cable entry nut plug
Universel avec presse-étoupe

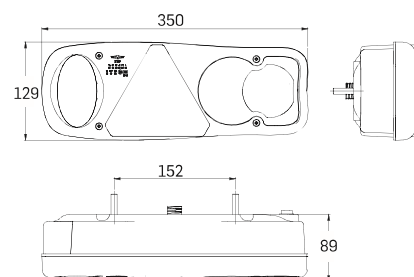

Example: X = 2
3169.2000250

Farolim direito com iluminação de chapa de matrícula, luz de posição lateral, conetor DIN posterior e homologação horizontal
RH lamp with registration plate light, side-marker lamp, back DIN plug and horizontal mounting approval
Feu arrière droit avec éclairage de plaque, feu de position latéral, connecteur DIN Postérieur et homologué position horizontal

3121

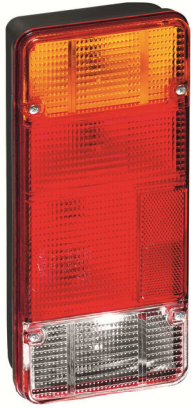
Referência Part N° Référence	Esquerdo Left Gauche	Direito Right Droit	Luz de Nevoeiro Fog Light Feu Anti-brouillard	Marcha Atrás Reversing Light Feu de Recul	Homologação Horizontal/Vertical Horizontal/Vertical Mounting Approval Homologué Position Horizontal/Vertical
3121.X000000		•		•	H
3121.X000100		•	•		H
3121.X000200	•			•	H
3121.X000300	•		•		H
3121.X000400	•			•	V
3121.X000600		•		•	V

Peças de Reposição
Spare parts
Pièces de rechange

Vidro esquerdo marcha atrás • Left lens reversing • Cabochon gauche recul	3121.0000210
Vidro esquerdo nevoeiro • Left lens fog • Cabochon gauche anti-brouillard	3121.0000310
Vidro direito marcha atrás • Right lens reversing • Cabochon droit recul	3121.0000010
Vidro direito nevoeiro • Right lens fog • Cabochon droit anti-brouillard	3121.0000110

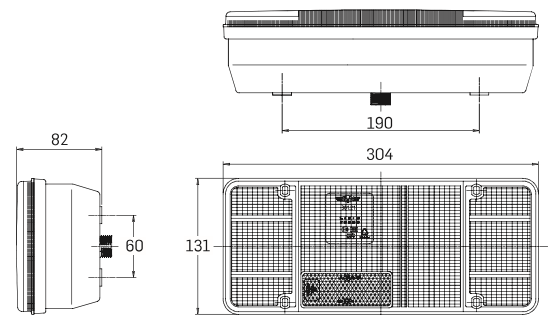

Conexão
Plug
Connection



X = 0
Compatível com IVECO
Compatible with IVECO
Compatible avec IVECO



X = 1
Universal com cabos
Universal with cables
Universel avec cable



X = 4
Universal com rosca
Universal w/ cable entry nut plug
Universel avec presse-étoupe

Example: X = 4
3121.4000100

Farolim direito com luz de nevoeiro, homologação horizontal e conexão universal com rosca.
RH lamp with fog light, and horizontal mounting approval and universal with cable entry nut plug
Feu arrière droit avec feu anti-brouillard, homologué position horizontal et connection universel avec presse-étoupe

PY 21W BAU 15s

P 21W BA 15s

R 10W BA 15s



Refletor triangular
Triangular reflex reflector
Catadioptre triangulaire

3197

NEWPRODUCT

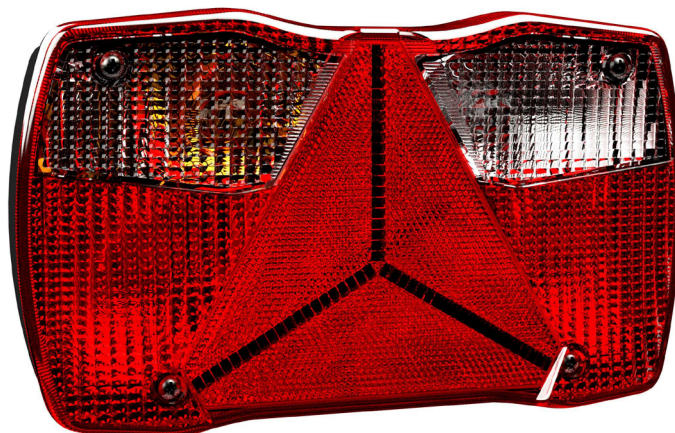

Referência Part N° Référence	Esquerdo Left Gauche	Direito Right Droit	Presença/STOP Position/STOP Veilleuse/STOP	Luz de Nevoeiro Fog Light Feu Anti-brouillard	Marcha Atrás Reversing Light Feu de Recul	Iluminação Chapa Matricula (inferior) Registration Plate Light (down side) Éclairage De Plaque (dessous)	Iluminação Chapa Matricula (lateral) Registration Plate Light (side) Éclairage De Plaque (latéral)
3197.X000000	•		BULB	•	•		
3197.X000080	•		BULB	•	•	•	
3197.X000090	•		BULB	•	•		•
3197.X000200		•	BULB	•	•		
3197.X000280		•	BULB	•	•	•	
3197.X000290		•	BULB	•	•		•
3197.X300000	•		LED	•	•		
3197.X300080	•		LED	•	•	•	
3197.X300090	•		LED	•	•		•
3197.X300200		•	LED	•	•		
3197.X300280		•	LED	•	•	•	
3197.X300290		•	LED	•	•		•

Conexão
Plug
Connection



X = 2
Conetor DIN posterior
Back DIN plug
Connecteur DIN postérieur



X = 4
Universal com rosca
Universal w/ cable entry nut plug
Universel avec presse-étoupe



X = 5
Conetor de 5 pinos
5 pins connector
Connecteur à 5 broches

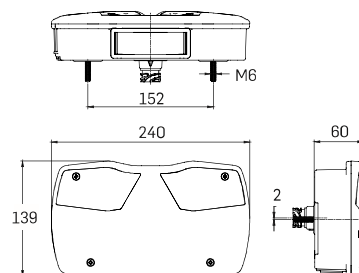

Example: X = 2
3197.2000200

Farolim direito com conetor DIN posterior
RH lamp with back DIN plug
Feu arrière droit avec connecteur DIN Postérieur

3149

Refletor retangular
Rectangular reflex reflector
Catadioptre rectangulaire



PTOTAL
9,5W - 12V
10W - 24V



B



A



Referência Part N° Référence	Esquerdo Left Gauche	Direito Right Droit	Nevoeiro Fog Light Anti-brouillard	Marcha Atrás Reversing Light Feu de Recul	Presença/Stop Position/Stop Veilleuse/Stop	Luz de Posição Lateral Side-Marker Lamp Feu de Position Lateral	Base Casing Cuvelage
3149.X000400	•		•	•	•		A
3149.X000451	•		•	•	•	•	B
3149.X000600		•	•	•	•		A
3149.X000651		•	•	•	•	•	B

Peças de Reposição
Spare parts
Pièces de rechange

Vidro esquerdo • Left lens • Cabochon gauche	3149.0000410
Vidro direito • Right lens • Cabochon droit	3149.0000610

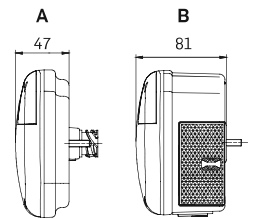
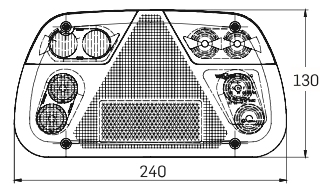
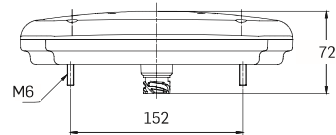

Conexão
Plug
Connection



X = 2
Conetor DIN posterior
Back DIN plug
Connecteur DIN postérieur



X = 4
Universal com rosca
Universal w/ cable entry nut plug
Universel avec presse-étoupe



X = 5
Conetor de 5 pinos*
5 pins connector*
Connecteur à 5 broches*

Example: X = 2
3149.2000600

Farolim direito com conetor DIN posterior • * Sem luz de nevoeiro ou sem luz de marcha atrás
Disponível com duas presenças (neste caso uma das funções de marcha atrás ou nevoeiro é eliminada)

RH lamp with back DIN plug • * Without fog light or without reversing light
Also available with two positions functions (in this case one of these functions fog or reverse is eliminated)

Feu arrière droit avec connecteur DIN Postérieur • * Sans feu anti-brouillard ou sans feu de recul.
Aussi disponible avec deux veilleuse (dans ce case, une des fonctions anti-brouillard ou feu de recul est éliminée)

PTOTAL
9,5W - 12V
10W - 24V



Refletor triangular
Triangular reflex reflector
Catadioptre triangular

3149



Referência Part N° Référence	Esquerdo Left Gauche	Direito Right Droit	Nevoeiro Fog Light Anti-brouillard	Marcha Atrás Reversing Light Feu de Recul	Presença/Stop Position/Stop Veilleuse/Stop	Luz de Posição Lateral Side-Marker Lamp Feu de Position Lateral	Base Casing Cuvelage
3149.X000000	•		•	•	•		A
3149.X000051	•		•	•	•	•	B
3149.X000200		•	•	•	•		A
3149.X000251		•	•	•	•	•	B

Peças de Reposição
Spare parts
Pièces de rechange

Vidro esquerdo • Left lens • Cabochon gauche	3149.0000010
Vidro direito • Right lens • Cabochon droit	3149.0000210

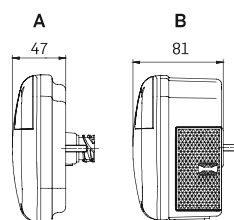
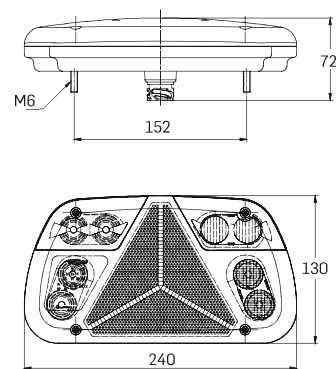

Conexão
Plug
Connection



X = 2
Conetor DIN posterior
Back DIN plug
Connecteur DIN postérieur



X = 4
Universal com rosca
Universal w/ cable entry nut plug
Universel avec presse-étoupe



X = 5
Conetor de 5 pinos*
5 pins connector*
Connecteur à 5 broches*

Example: X = 2
3149.2000200

Farolím direito com conetor DIN posterior • * Sem luz de nevoeiro ou sem luz de marcha atrás
Disponível com duas presenças (neste caso uma das funções de marcha atrás ou nevoeiro é eliminada)

RH lamp with back DIN plug • * Without fog light or without reversing light
Also available with two positions functions (in this case one of these functions fog or reverse is eliminated)

Feu arrière droit avec connecteur DIN Postérieur • * Sans feu anti-brouillard ou sans feu de recul.
Aussi disponible avec deux veilleuse (dans ce case, une des foncions anti-brouillard ou feu de recul est éliminée)

3150

Refletor retangular
Rectangular reflex reflector
Catadioptrre rectangulaire



P 21W BA 15s

R 5W BA 15s



Referência Part N° Référence	Esquerdo Left Gauche	Direito Right Droit	Iluminação Chapa Matricula Registration Plate Light Éclairage de Plaque	Luz de Posição Lateral Side-Marker Lamp Feu de Position Lateral	Delimitador End Outline Feu de Gabari
3150.X000400	•				
3150.X000450	•			•	
3150.X000460	•				•
3150.X000500	•		•		
3150.X000550	•		•	•	
3150.X000560	•		•		•
3150.X000600		•			
3150.X000650		•		•	
3150.X000660		•			•
3150.X000700		•	•		
3150.X000750		•	•	•	
3150.X000760		•	•		•

Peças de Reposição
Spare parts
Pièces de rechange

Vidro esquerdo • Left lens • Cabochon gauche	3150.0000410
Vidro direito • Right lens • Cabochon droit	3150.0000610

Conexão
Plug
Connection



X = 2
Conetor DIN posterior
Back DIN plug
Connecteur DIN postérieur



X = 4
Universal com rosca
Universal w/ cable entry nut plug
Universel avec presse-étoupe



X = 5
Conetor de 5 pinos*
5 pins connector*
Connecteur à 5 broches*

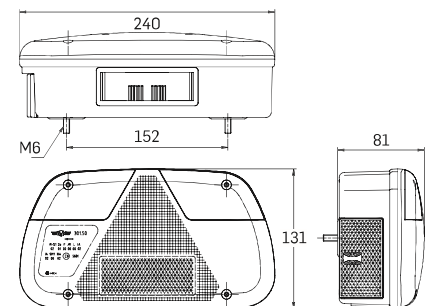

Example: X = 2
3150.2000750

Farolim direito com iluminação de chapa de matrícula, luz de posição lateral e conetor DIN posterior • * Sem luz de nevoeiro ou sem luz de marcha atrás
Disponível com duas presenças (neste caso uma das funções de marcha atrás ou nevoeiro é eliminada)

RH lamp with registration plate light, side-marker lamp and back DIN plug • *Without fog light or without reversing light
Also available with two positions functions (in this case one of these functions fog or reverse is eliminated)

Feu arrière droit avec éclairage de plaque, feu de position latéral et connecteur DIN postérieur • *Sans feu anti-brouillard ou sans feu de recul.
Aussi disponible avec deux veilleuse (dans ce case, une des foncions anti-brouillard ou feu de recul est éliminée)

3139



P 21/5W BAY 15d

P 21W BA 15s



Referência Part N° Référence	Esquerdo Left Gauche	Direito Right Droit	Luz de Nevoeiro Fog Light Feu Anti-brouillard	Marcha Atrás Reversing Light Feu de Recul	Iluminação Chapa Matricula Registration Plate Light Éclairage de Plaque
3139.X000000		•		•	•
3139.X000050		•		•	
3139.X000100		•	•		•
3139.X000150		•	•		
3139.X000200	•			•	•
3139.X000250	•			•	
3139.X000300	•		•		•
3139.X000350	•		•		

Peças de Reposição
Spare parts
Pièces de rechange

Vidro esquerdo marcha atrás • Left lens reversing • Cabochon gauche recul	3139.0000210
Vidro esquerdo nevoeiro • Left lens fog • Cabochon gauche anti-brouillard	3139.0000310
Vidro direito marcha atrás • Right lens reversing • Cabochon droit recul	3139.0000010
Vidro direito nevoeiro • Right lens fog • Cabochon droit anti-brouillard	3139.0000110

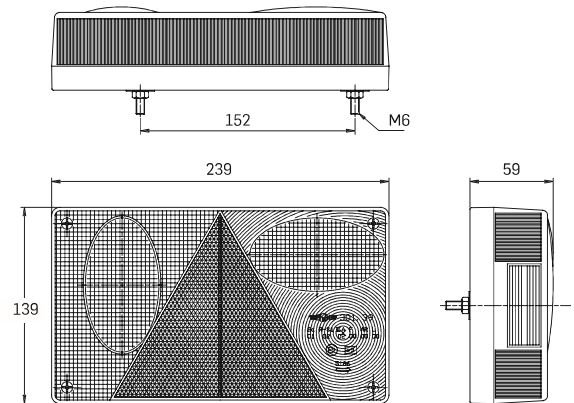

Conexão
Plug
Connection



X = 0
Conetor original
Original plug
Connecteur original



X = 1
Universal com cabo
Universal with cable
Universel avec cable



X = 2
Universal com passa-fios
Universal with grommet
Universel avec passe-fils



X = 5
Conetor de 5 pinos
5 pins connector
Connecteur à 5 broches

Example: X = 5
3139.5000300

Farolim esquerdo com luz de nevoeiro, iluminação de chapa de matrícula e conetor de 5 pinos
LH lamp with fog light, registration plate light and 5 pins plug
Feu arrière gauche avec feu anti-brouillard, éclairage de plaque et connecteur à 5 broches

P 21/5W BAY 15d
 P 21W BA 15s



3145



Referência Part N° Référence	Esquerdo Left Gauche	Direito Right Droit	Luz de Nevoeiro Fog Light Feu Anti-brouillard	Marcha Atrás Reversing Light Feu de Recul	Iluminação Chapa Matricula (lateral) Registration Plate Light (side) Éclairage De Plaque (latéral)	Iluminação Chapa Matricula (inferior) Registration Plate Light (down side) Éclairage De Plaque (dessous)
3145.00000X0		•		•	•	
3145.00001X0		•		•		
3145.00002X0		•		•		•
3145.00003X0		•	•		•	
3145.00004X0		•	•			
3145.00005X0		•	•			•
3145.10000X0	•			•	•	
3145.10001X0	•			•		
3145.10002X0	•			•		•
3145.10003X0	•		•		•	
3145.10004X0	•		•			
3145.10005X0	•		•			•

Vidro Lens Cabochon	Esquerdo Left Gauche	Direito Right Droit	Luz de Nevoeiro Fog Light Feu Anti-brouillard	Marcha Atrás Reversing Light Feu de Recul	Iluminação Chapa Matricula (lateral) Registration Plate Light (side) Éclairage De Plaque (latéral)	Iluminação Chapa Matricula (inferior) Registration Plate Light (down side) Éclairage De Plaque (dessous)
3145.0000010		•		•	•	
3145.0000110		•		•		
3145.0000210		•		•		•
3145.0000310		•	•		•	
3145.0000410		•	•			
3145.0000510		•	•			•
3145.1000010	•			•	•	
3145.1000110	•			•		
3145.1000210	•			•		•
3145.1000310	•		•		•	
3145.1000410	•		•			
3145.1000510	•		•			•

Conexão
 Plug
 Connection



X = 0
 Universal com passa-fios
 Universal with grommet
 Universel avec passe-fils



X = 5
 Conetor de 5 pinos
 5 pins connector
 Connecteur à 5 broches



X = 9
 Universal com cabo
 Universal with cable
 Universel avec cable

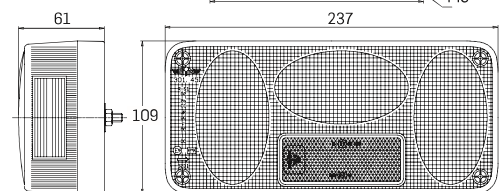

Example: **X = 0**
3145.1000500

Farolim esquerdo com luz de nevoeiro, iluminação de chapa de matrícula (inferior) com passa-fios.
 LH lamp with fog light, registration plate light (down side) and universal with grommet plug
 Feu arrière gauche avec feu anti-brouillard, éclairage de plaque (dessous) et connecteur universel avec passe-fils

3127



P 21/5W BAY 15d

P 21W BA 15s



Referência Part N° Référence	Esquerdo Left Gauche	Direito Right Droit	Luz de Nevoeiro Fog Light Feu Anti-brouillard	Marcha Atrás Reversing Light Feu de Recul	Iluminação Chapa Matricula (lateral) Registration Plate Light (side) Éclairage De Plaque (latéral)	Homologação Horizontal/Vertical Horizontal/Vertical Mounting Approval Homologué Position Horizontal/Vertical
3127.X100000		•		•	•	H
3127.X100090		•		•		H
3127.X100100	•		•		•	H
3127.X100190	•		•			H
3127.X100200		•	•		•	H
3127.X100290		•	•			H
3127.X100300	•			•	•	H
3127.X100390	•			•		H
3127.X200090		•		•		V
3127.X200190	•		•			V
3127.X200290		•	•			V
3127.X200390	•			•		V

Vidro Lens Gabochon	Esquerdo Left Gauche	Direito Right Droit	Cor Colour Couleur	Horizontal Horizontal Horizontal	Vertical Vertical Vertical
3127.0100010		•		•	
3127.0100110	•			•	
3127.0100210		•		•	
3127.0100310	•			•	
3127.0200010		•			•
3127.0200110	•				•
3127.0200210		•			•
3127.0200310	•				•

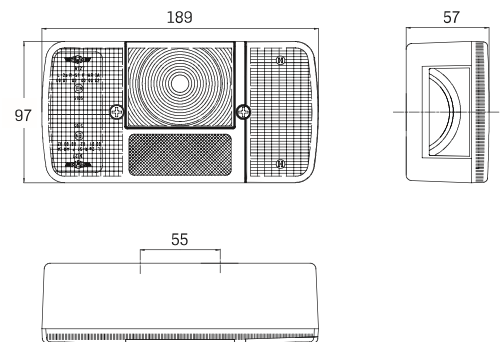

Conexão
Plug
Connection



X = 0
Universal com passa-fios
Universal with grommet
Universel avec passe-fils



X = 5
Conetor de 5 pinos
5 pins connector
Connecteur à 5 broches

Example: X = 5

3127.5100290

Farolim direito com luz de nevoeiro e conetor de 5 pinos
RH lamp with fog light and 5 pins plug
Feu arriere droit avec feu anti-brouillard et Connecteur à 5 broches

PTOTAL
4,3W - 12V
8,8W - 24V



3185

NEWPRODUCT

Referência Part N° Référence	Esquerdo Left Gauche	Direito Right Droit	Presença/ STOP Position/STOP Veilleuse/STOP	Marcha Atrás Reversing Light Feu de Recul	Pisca Side-indicator Clignotant
3185.X000000	•		LED	LED	LED
3185.X000200		•	LED	LED	LED

Peças de Reposição
Spare parts
Pièces de rechange

Vidro esquerdo • Left lens • Cabochon gauche	3185.0000110
Vidro direito • Right lens • Cabochon droit	3185.0000310

Conexão
Plug
Connection



X = 5
Conetor de 5 pinos
5 pins connector
Connecteur à 5 broches

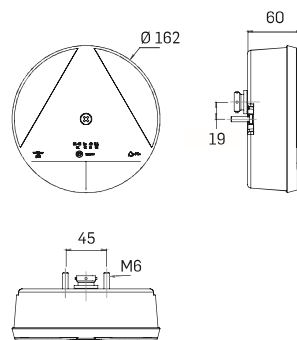

Example: X = 5
3185.5000200

Farolim direito com conetor de 5 pinos
RH lamp with 5 pins plug
Feu arriere droit avec connecteur à 5 broches

P 21W BA 15s P21/5W BAY 15d



3185

NEWPRODUCT

Referência Part N° Référence	Esquerdo Left Gauche	Direito Right Droit	Presença/ STOP Position/STOP Veilleuse/STOP	Marcha Atrás Reversing Light Feu de Recul	Pisca Side-indicator Clignotant
3185.X000030	•		LED	BULB	BULB
3185.X000230		•	LED	BULB	BULB
3185.X000020	•		BULB	BULB	BULB
3185.X000220		•	BULB	BULB	BULB

Peças de Reposição
Spare parts
Pièces de rechange

Vidro esquerdo • Left lens • Cabochon gauche	3185.0000010
Vidro direito • Right lens • Cabochon droit	3185.0000210

Conexão
Plug
Connection



X = 5
Conetor de 5 pinos
5 pins connector
Connecteur à 5 broches

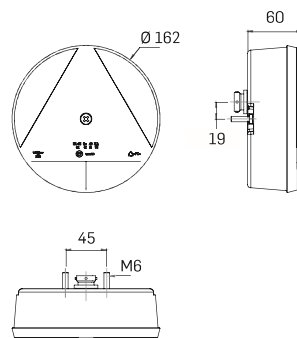

Example: X = 5
3185.5000230

Farolim direito com presença/STOP LED e conetor de 5 pinos
RH lamp with position/STOP LED and 5 pins plug
Feu arriere droit avec veilleuse/STOP LED et connecteur à 5 broches

3172



P 21/5W BAY 15d P 21W BA 15s



Esquerdo
Left
Gauche

Direito
Right
Droit

Referência Part N° Référence	Esquerdo Left Gauche	Direito Right Droit	Luz de Nevoeiro Fog Light Feu Anti-brouillard	Marcha Atrás Reversing Light Feu de Recul
3172.X000000	•			•
3172.X000100	•		•	
3172.X000200		•		•
3172.X000300		•	•	

Peças de Reposição
Spare parts
Pièces de rechange

Vidro esquerdo marcha atrás • Left lens reversing • Cabochon gauche recul	3172.0000010
Vidro esquerdo nevoeiro • Left lens fog • Cabochon gauche anti-brouillard	3172.0000110
Vidro direito marcha atrás • Right lens reversing • Cabochon droit recul	3172.0000210
Vidro direito nevoeiro • Right lens fog • Cabochon droit anti-brouillard	3172.0000310

Conexão
Plug
Connection



X = 4
Universal com rosca
Universal w/ cable entry nut plug
Universel avec presse-étoupe



X = 5
Conetor de 5 pinos
5 pins connector
Connecteur à 5 broches

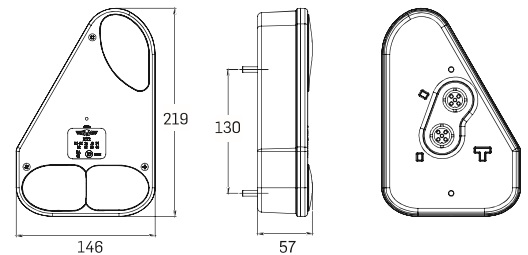

3195



PTOTAL
2,0W - 12V
4,0W - 24V

NEWPRODUCT



Referência Part N° Référence	Presença/ STOP Position/STOP Veilleuse/STOP	Marcha Atrás Reversing Light Feu dec Recul	Pisca Side-indicator Clignotant
3195.0305000	LED	LED	LED

Peças de Reposição
Spare parts
Pièces de rechange

Vidro • Lens • Cabochon	3195.0000010
-------------------------	--------------

Com cabo 500mm, disponíveis outros comprimentos de cabo; consulte-nos!
With cable 500mm, available other length of cables; please check with us!
Avec cable 500mm, d'autres longueurs de câble possibles; merci nos consulter!

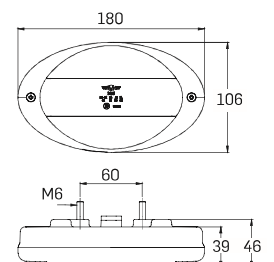

PTOTAL
5W - 12V
5,5W - 24V



3179

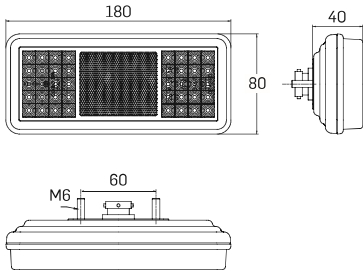

ON



OFF

Conexão
Plug
Connection



3179.5000000
Conetor de 5 Pinos
5 Pins Plug
Connecteur à 5 broches



3179.0105000
Com cabo 500mm
With cable 500mm
Avec cable 500mm

Disponíveis outros comprimentos de cabo; consulte-nos!
Available other length of cables; please check with us!
D'autres longueurs de câble possibles; merci nos consulter!

PTOTAL
5W - 12V
5,5W - 24V



3159

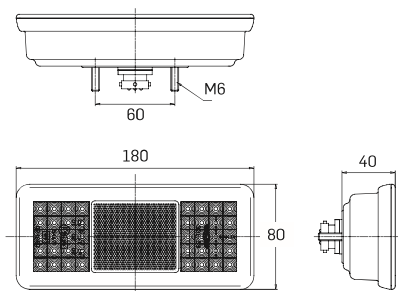

ON



OFF

Conexão
Plug
Connection



3159.5000000
Conetor de 5 Pinos
5 Pins Plug
Connecteur à 5 broches



3159.0105000
Com cabo 500mm
With cable 500mm
Avec cable 500mm

Disponíveis outros comprimentos de cabo; consulte-nos!
Available other length of cables; please check with us!
D'autres longueurs de câble possibles; merci nos consulter!

3180



PTOTAL
2W - 12/24V (white)
3W - 12/24V (red / yellow)



3180.0305500
Luz de Nevoeiro
Fog Light
Feu Anti-Brouillard



3180.0305200
Presença/STOP
Position/STOP
Veilleuse/STOP



3180.0305100
Pisca
Side-indicator
Clignotant



3180.0305000
Luz de Marcha Atrás
Reversing Light
Feu de Recul

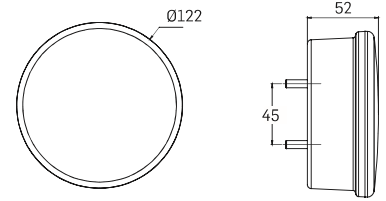

Com cabo 500mm, disponíveis outros comprimentos de cabo; consulte-nos!
With cable 500mm, available other length of cables; please check with us!
Avec cable 500mm, d'autres longueurs de câble possibles; merci nos consulter!

3164



P 21/5W BAY 15d P 21W BA 15s



Referência Part N° Référence	Cor Colour Couleur
3164.0000000	○
3164.0000100	●
3164.0000200	● pos • stop
3164.0000300	●
3164.0000400	●
3164.0000500	● nev • fog • brouil

Peças de Reposição Spare parts Pièces de rechange	
3164.0000010	○
3164.0000110	●
3164.0000210	●
3164.0000310	●
3164.0000410	●

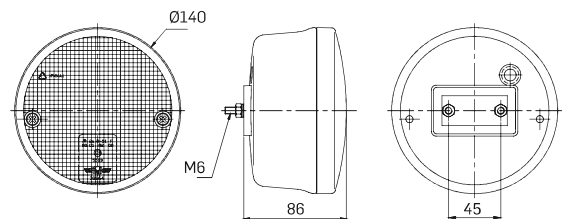

PTOTAL
5,5W - 12V
6W - 24V



3188

NEW PRODUCT



OFF



OFF



OFF



ON



ON



ON

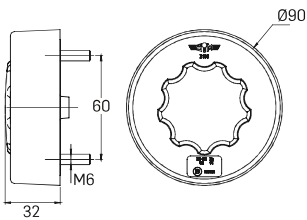

Referência Part N° Référence	Presença/ STOP e Pisca Position/STOP and Side-Indicator Veilleuse/STOP et Clignotant	Luz de Marcha Atrás Reversing Light Feu dec Recul	Luz de Nevoeiro Fog Light Feu Anti-Brouillard	Pisca Atrás Back Side-Indicator Clignotant	Pisca Frente Front Side-Indicator Clignotant Avant	Presença e Pisca Frente Position and Front Side-indicator Veilleuse et Clignotant Avant	Com cabo 500mm * With cable 500mm * Avec cable 500mm *
3188.0305100	•						•
3188.0305000		•					•
3188.0305500			•				•
3188.0305800				•			•
3188.0305700					•		•
3188.0305600						•	•

* Disponíveis outros comprimentos de cabo; consulte-nos!
* Available other length of cables; please check with us!
* D'autres longueurs de câble possibles; merci nos consulter!

Configuradas conforme exigências do cliente
Customized as per client requirements
Sur demande



3164



PTOTAL
2W - 12/24V - 1F
2,4W - 12/24V - 1F

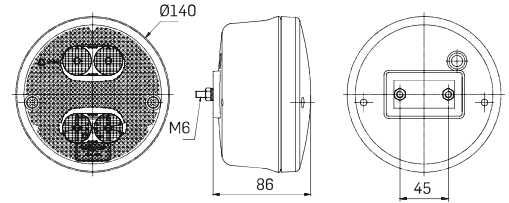

Conexão
Plug
Connection



X = 0
Universal com passa-fios
Universal with grommet
Universel avec passe-fils



X = 5
Conetor de 5 pinos
5 pins connector
Connecteur à 5 broches

Referência Part N° Référence	Pres/STOP Pos/STOP Pos/STOP	Pisca Side-indicator Clignotant	Luz Nevoeiro Fog Light Feu Anti-brouillard	Marcha Atrás Reversing Light Feu de Recul	Refletor Ref. Reflector Catadioptré	OFF OFF OFF	ON ON ON
3164.6X00000				•	•		
3164.6X00100		•			•		
3164.6X00200	•				•		
3164.6X00400			•	•			
3164.6X00500			•		•		
3164.6X00600		•	•				

3164

Base Fina
Slim Casing
Boitier Petit

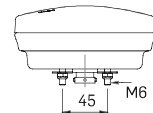

PTOTAL
2W - 12V - 1F
2,4W - 24V - 1F
6W - 12V - 3F
7W - 24V - 3F

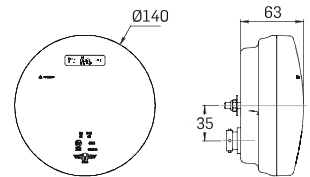

Conexão
Plug
Connection



X = 4
Universal com rosca
Universal with cable
entry nut plug
Universel avec presseétoupe



X = 5
Conetor de 5 pinos
5 pins connector
Connecteur à 5 broches

Referência Part N° Référence	Pres/STOP Pos/STOP Pos/STOP	Pisca Side-indicator Clignotant	Luz Nevoeiro Fog Light Feu Anti-brouillard	Marcha Atrás Reversing Light Feu de Recul	Refletor Ref. Reflector Catadioptré	OFF OFF OFF	ON ON ON
3164.8X00000	•	•					
3164.9X00000				•	•		
3164.9X00100		•			•		
3164.9X00200	•				•		
3164.9X00400			•	•			
3164.9X00500			•		•		
3164.9X00600		•	•				

P 21W BA 15s R 5W BA 15s

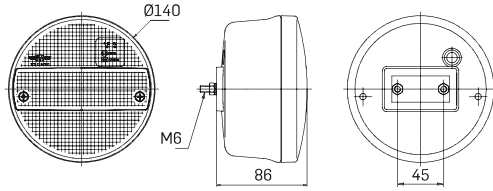

Referência
Part N°
Référence

Iluminação Chapa Matricula
Registration Plate Light
Éclairage De Plaque

Peças de Reposição
Spare parts
Pièces de rechange

3111.0X00000

3111.0X00100

Conexão • Plug • Connection

Vidro • Lens • Cabochon 3111.0000010

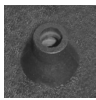

X = 0
Universal com passa-fios
Universal with grommet
Universel avec passe-fils



X = 5
Conetor de 5 pinos
5 pins connector
Connecteur à 5 broches



3111



PTOTAL
6W - 12V
7W - 24V

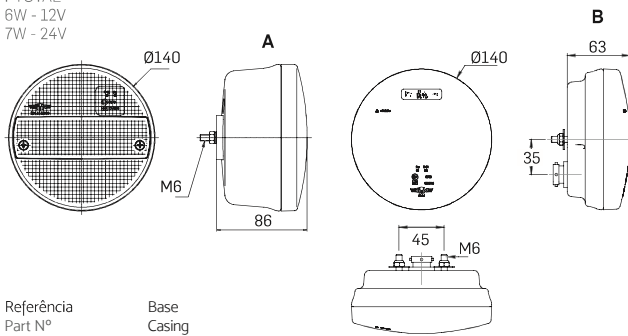

Referência
Part N°
Référence

Base
Casing
Cuvelage

Peças de Reposição
Spare parts
Pièces de rechange

3111.5X00000 A

3111.8X00000 B

Conexão • Plug • Connection

Vidro • Lens • Cabochon 3111.5000010



X = 0
Universal com passa-fios
Universal with grommet
Universel avec passe-fils



X = 5
Conetor de 5 pinos
5 pins connector
Connecteur à 5 broches



3111

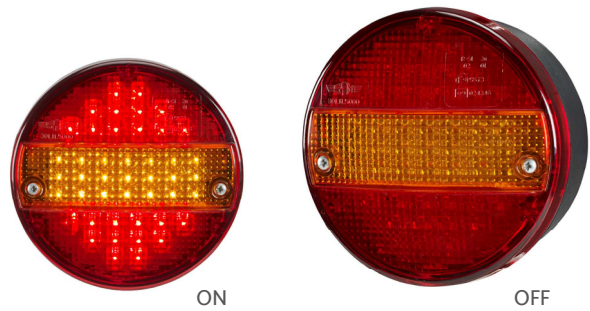

PTOTAL
6W - 12V
7W - 24V

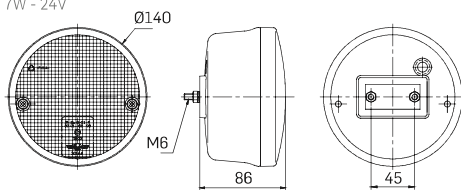

Referência
Part N°
Référence

Peças de Reposição
Spare parts
Pièces de rechange

3164.5X00000

Conexão • Plug • Connection

Vidro • Lens • Cabochon 3164.5000010



X = 0
Universal com passa-fios
Universal with grommet
Universel avec passe-fils



X = 5
Conetor de 5 pinos
5 pins connector
Connecteur à 5 broches



3164



3152



P 21/5W BAY 15d

P 21W BA 15s



Referência
Part N°
Référence

Cor
Colour
Couleur

3152.0000000	
3152.0000100	
3152.0000200	pos stop
3152.0000300	
3152.0000500	nev fog brouill

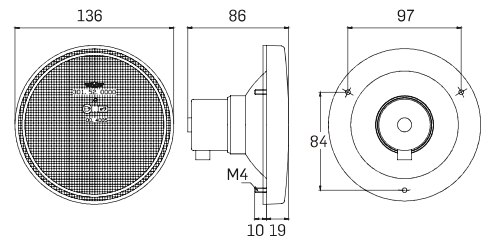

3125



P 21/5W BAY 15d

P 21W BA 15s



Referência
Part N°
Référence

3125.0000000

Peças de Reposição
Spare parts
Pièces de rechange

Vidro · Lens · Cabochon 3125.0000010

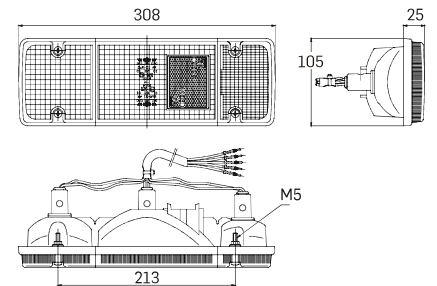

3126



P 21/5W BAY 15d

P 21W BA 15s

R 5W BA 15s



Referência
Part N°
Référence

3126.0000000

Peças de Reposição
Spare parts
Pièces de rechange

Vidro · Lens · Cabochon 3126.0000010

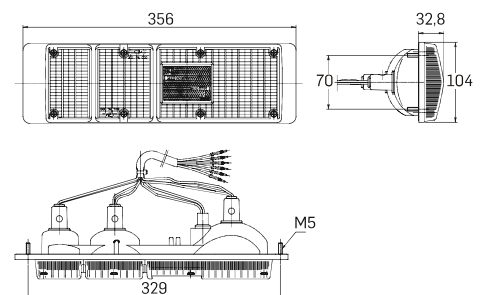

P 21/5W BAY 15d
 P 21W BA 15s
 R 5W BA 15s

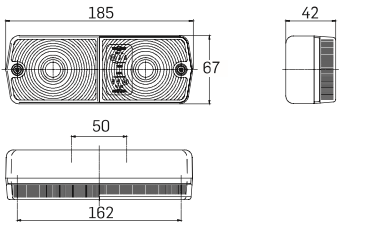

Referência Cor
 Part N° Colour
 Référence Couleur

3114.000000	
3114.000010	

E **3114**



P 21/5W BAY 15d
 P 21W BA 15s
 R 5W BA 15s

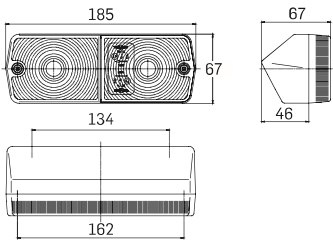

Referência Cor
 Part N° Colour
 Référence Couleur

3114.100000	
3114.100010	

Vidro Cor
 Lens Colour
 Cabochon Couleur

3114.000010	
3114.000011	



P 21/5W BAY 15d
 R 10W BA 15s

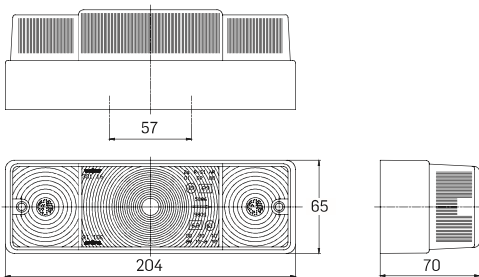

Referência Cor
 Part N° Colour
 Référence Couleur

3116.000000	
3116.000010	

Vidro Cor
 Lens Colour
 Cabochon Couleur

3116.000010	
3116.000011	

E **3116**



3166



P 21/5W BAY 15d
 P 21W BA 15s
 R 5W BA 15s



Referência Part N° Référence	Farolim Dianteiro Front Lamp Feu Avant	Cor Colour Couleur	Ind. mud. Direcção + Pres + Stop Direction Indicator + Pos + Stop Avec Clignotant + Pos + Stop	Iluminação de Matrícula Registration Plate Light Éclairage de Plaque
3166.X000000	•			
3166.X000100			•	•
3166.X000150			•	

Vidro
Lens
Caboçon

Cor
Colour
Couleur

3166.0000010



3166.0000110

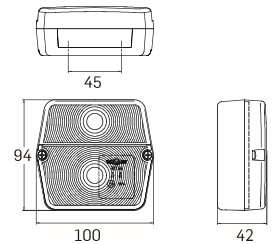

Conexão
Plug
Connection



X = 0
 Universal com passa-fios
 Universal with grommet
 Universel avec passe-fils



X = 5
 Conector de 5 pinos
 5 pins connector
 Connecteur à 5 broches

Example: X = 5
 3166.5000100

Farolim com Iluminação de Matrícula e conetor de 5 pinos
 Lamp with Registration Plate Light and 5 pins plug
 Feu avec Éclairage de Plaque et Connecteur à 5 broches

3118

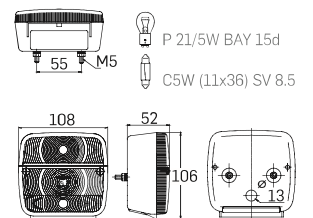
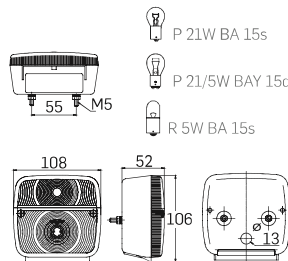

Referência Part N° Référence	Farolim Dianteiro Front Lamp Feu Avant	Cor Colour Couleur	3 Lâmpadas 3 Lamps 3 Ampoules	2 Lâmpadas 2 Lamps 2 Ampoules	Pres/STOP Pos/STOP Pos/STOP	Iluminação de Matrícula Registration Plate Light Éclairage de Plaque
3118.1X00000	•			•		
3118.0X00100			•		•	•
3118.0X00150			•		•	
3118.1X00100				•	•	•
3118.1X00150				•	•	

Vidro
Lens
Caboçon

Cor
Colour
Couleur

3118.1000010



3118.0000110



3118.1000110



Conexão
Plug
Connection



X = 0
 Universal com passa-fios
 Universal with grommet
 Universel avec passe-fils



X = 5
 Conector de 5 pinos
 5 pins connector
 Connecteur à 5 broches

Example: X = 5
 3118.0500100

Farolim com 3 Lâmpadas, Iluminação de Matrícula e conetor de 5 pinos
 Lamp with 3 Lamps and Registration Plate Light and 5 pins plug
 Feu avec 3 Ampoules, Éclairage de Plaque et Connecteur à 5 broches

P 21/5W BAY 15d P 21W BA 15s



Base plana
Surface mounting
A plaquer

3132

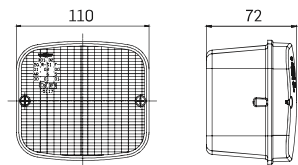

Referência Part N° Référence	Cor Colour Couleur
3132.9000000	○
3132.9000100	●
3132.9000200	● pos • stop
3132.9000300	●
3132.9000400	●
3132.9000500	● nev • fog • brouil



P 21/5W BAY 15d P 21W BA 15s

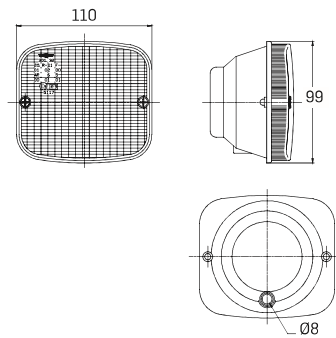

Referência Part N° Référence	Cor Colour Couleur
3132.0000000	○
3132.0000100	●
3132.0000200	● pos • stop
3132.0000300	●
3132.0000400	●
3132.0000500	● nev • fog • brouil

Para encastrar
Flush fitting
Pour encastrer



P 21/5W BAY 15d P 21W BA 15s

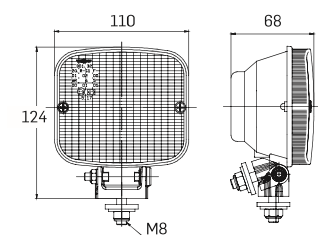

Referência Part N° Référence	Cor Colour Couleur
3132.1000000	○
3132.1000100	●
3132.1000200	● pos • stop
3132.1000300	●
3132.1000400	●
3132.1000500	● nev • fog • brouil

Com pivot de fixação
With bracket
Avec pivot de fixation



Vidro
Lens
Cabochon

3132.0000010	○
3132.0000110	●
3132.0000210	●
3132.0000310	●
3132.0000410	●

3132

Com pendural flexivel
With flexible holder
Avec support flexible



P 21/5W BAY 15d

P 21W BA 15s



Referência Part N° Référence	Cor Colour Couleur	
3132.2000000		
3132.2000100		pos • stop
3132.2000200		pos • stop
3132.2000300		
3132.2000400		
3132.2000500		pos • stop

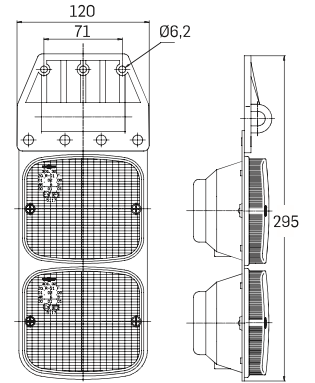

Com pendural flexivel
With flexible holder
Avec support flexible

P 21/5W BAY 15d

P 21W BA 15s

Referência Part N° Référence	Cor Colour Couleur	
3132.3000000		pos • stop
3132.3000100		
3132.3000200		pos • stop
3132.3000300		pos • stop
3132.3000500		pos • stop nev • fog • brouill

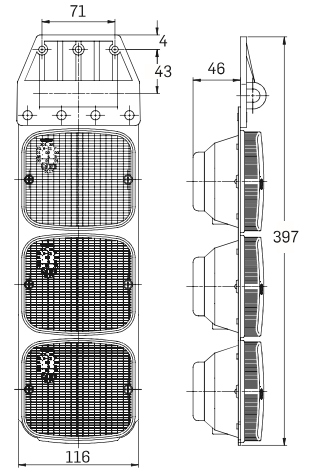

Base metálica com Refletor
Metal holder with reflex reflector
Support metal avec catadioptre

P 21/5W BAY 15d

P 21W BA 15s

Referência Part N° Référence	Cor Colour Couleur		Vidro Lens Cabocheon
3132.4000000		pos • stop	
3132.4000100			
3132.4000200		pos • stop	3132.0000010
3132.4000300		pos • stop	3132.0000110
3132.4000500		pos • stop nev • fog • brouill	3132.0000210
			3132.0000310

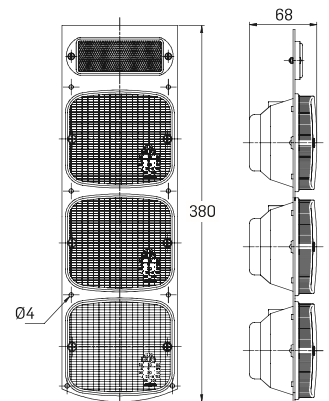

PTOTAL
2W - 12V
2,4W - 24V



3167



A		B			E	
0	•	2	•		0	Luz Marcha Atrás Reversing Light Feu de Recul
1	•	3	•		1	Pisca Atrás Back Side-indicator Clignotant
		CD Comprimento do Cabo Cable Length Longueur du Câble			2 Presença/STOP Position/STOP Veilleuse/STOP	
		05 500mm 35 3500mm 50 5000mm			5 Luz Nevoeiro Fog Light Feu Anti-brouillard	
					6 Presença Frente Front Position Veilleuse Avant	
					7 Pisca Frente Front Side-indicator Clignotant Avant	

3167. **ABCDE**00



3167. **1 2 05 200** Example: A=1 + B=2 + CD=05 + E=2

Farolim com pendural, conector click-in, cabo com 500mm, presença/stop
 Rear position/stop lamp with bracket, click-in connector, cable 500mm
 Feu de position avec support, connectique click-in, câble 500mm veilleuse/stop

P 21W BA 15s



3128

Referência Part N° Référence	Cor Colour Couleur
3128.0000000	○
3128.0000100	●
3128.0000500	● neveiro · fog · brouillard
Peças de Reposição Spare parts Pièces de rechange	
3128.0000010	○
3128.0000110	●
3128.0000510	●



3123



P 21W BA 15s R 5W BA 15s



Referência Part N° Référence	Cor Colour Couleur	Vidro Lens Caboçon	Cor Colour Couleur
3123.0000000	○	○	○
3123.0000100	●	3123.0000010	○
3123.0000200	●	3123.0000110	●
3123.0000300	●	3123.0000210	●
3123.0000400	●	3123.0000310	●
3123.0000500	●	3123.0000410	●
		3123.0000510	●

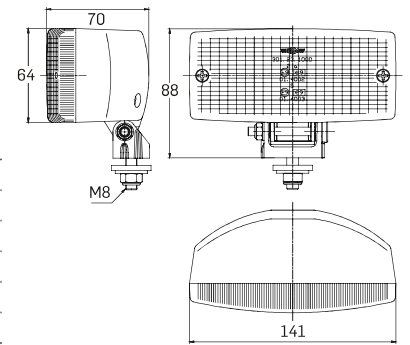

3122



P 21W BA 15s



Referência Part N° Référence	Cor Colour Couleur	Vidro Lens Caboçon	Cor Colour Couleur
3122.0000000	○	○	○
3122.0000100	●	3122.0000010	○
3122.0000200	●	3122.0000110	●
3122.0000300	●	3122.0000210	●
3122.0000400	●	3122.0000310	●
		3122.0000410	●

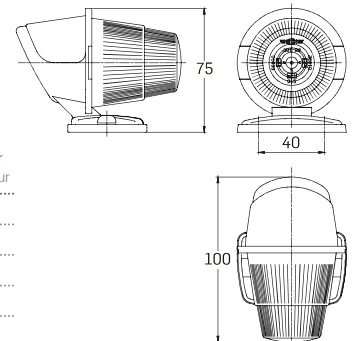

202.01

Carça de borracha
Rubber housing
Cuvelage caoutchouc

Vidro em policarbonato
Polycarbonate lens
Caboçon polycarbonate



BA 15s



Referência Part N° Référence	Cor Colour Couleur
202.01.9000	○
202.01.9100	●
202.01.9200	●
202.01.9500	●

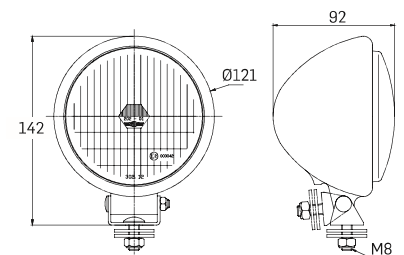

P 21W BA 15s
 R 10W BA 15s



3173

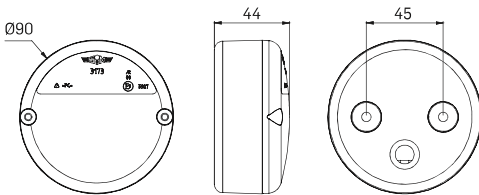

Referência Part N° Référence	Cor Colour Couleur	Vidro Lens Caboçon	Cor Colour Couleur
3173.0000000	○	3173.0000010	○
3173.0000100	●	3173.0000110	●
3173.0000200	● pos	3173.0000210	● pos
3173.0000500	● nev · fog · brouil	3173.0000510	● nev · fog · brouil
3173.0000600	● STOP	3173.0000610	● STOP

P 21W BA 15s
 R 10W BA 15s



Com Pivot de Fixação
With Bracket
Avec Pivot de Fixation

3101

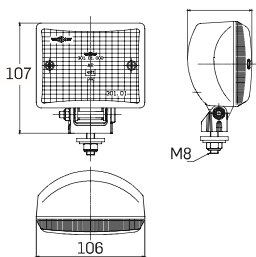

Referência Part N° Référence	Cor Colour Couleur
3101.0000000	○
3101.0000100	●
3101.0000200	●
3101.0000300	●



Base plana
Surface Mounting
A Plaquer

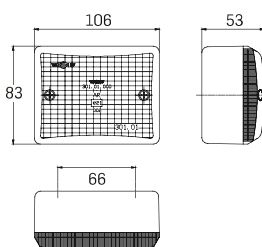

Referência Part N° Référence	Cor Colour Couleur	Vidro Lens Caboçon	Cor Colour Couleur
3101.1000000	○	3101.0000010	○
3101.1000100	●	3101.0000110	●
3101.1000200	●	3101.0000210	●
3101.1000300	●	3101.0000310	●



3113



P 21W BA 15s



Referência Part N° Référence	Cor Colour Couleur	Material Material Matériel	Vidro Lens Cabochon	Cor Colour Couleur	Material Material Matériel
3113.0000000	○	PMMA			
3113.0000100	●	PMMA	3113.0000010	○	PMMA
3113.0000200	●	PMMA	3113.0000110	●	PMMA
3113.0000300	●	PMMA	3113.0000210	●	PMMA
3113.1000000	○	PC	3113.0000310	●	PMMA
3113.1000100	●	PC	3113.1000010	○	PC
3113.1000200	●	PC	3113.1000110	●	PC
3113.1000300	●	PC	3113.1000210	●	PC
			3113.1000310	●	PC

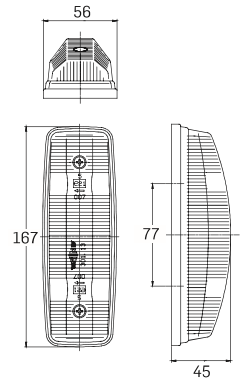

3124



BA 9s 5W



Referência Part N° Référence	Cor Colour Couleur	Vidro Lens Cabochon	Cor Colour Couleur
3124.0000000	△		△
3124.0000100	▲	3124.0000010	△
3124.0000200	▲	3124.0000110	▲
3124.0000300	▲	3124.0000210	▲
3124.0000400	▲	3124.0000310	▲
		3124.0000410	▲

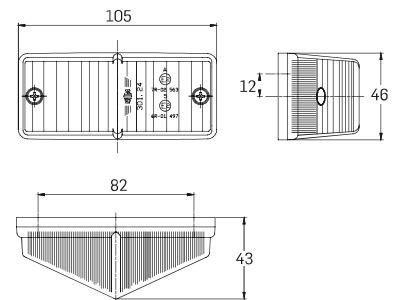

PTOTAL
2W - 12V
3,3W - 24V



0501

NEW PRODUCT



LIFE-SAVING LIGHTING SYSTEM DOWNLIGHT
SEE CLEARLY NOW - BEING SEEN!
LIGHT AROUND THE VEHICLE



A		B		CD	
		CLICK-IN	SUPERSEAL	Comprimento do Cabo Cable Length Longueur du Câble	
0				05	500mm
1				35	3500mm
				50	5000mm

A		B		CD	
		CLICK-IN	SUPERSEAL	Comprimento do Cabo Cable Length Longueur du Câble	
2				05	500mm
1				35	3500mm
5				50	5000mm

Na versão com dois faróis, A=0, ambos têm o mesmo comprimento de cabo e o mesmo conector.

Model of 2 lamps fitted, A=0, both should have same cable's length and plug.

Pour la version à deux feux, A=0, ils devront avoir la même longueur de câble et connectique.

Downlight com conector click-in e cabo retangular de 500mm
Downlight lamp, click-in connector and flat cable 500mm
Downlight, connectique click-in, câble plat 500mm

0501.AB.0.CD100

0501.1 2.0.05100

Example: A=1 + B=2 + CD=05

3182



C5W (11x36) SV 8.5



A

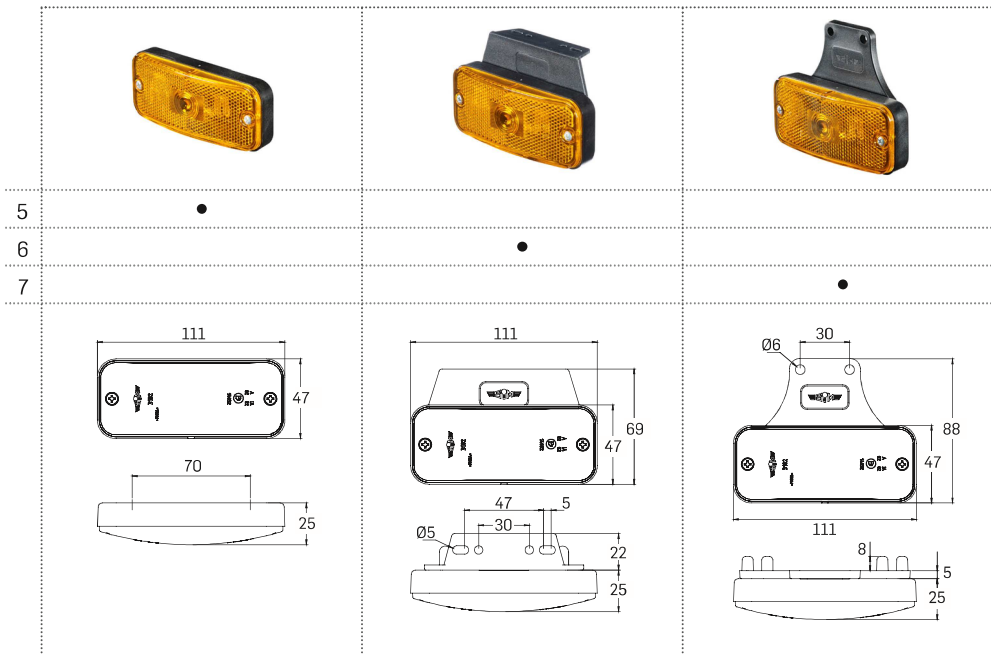

B

	Cor Colour Couleur	Vidro Lens Caboçon	Cor Colour Couleur
0	○		
1	●		
2	●	3182.5000010	○
3	●	3182.5000110	●
		3182.5000210	●
5	●	3182.5000310	●
		3182.5000510	●

3182.A000B00
 ↓ ↓
 3182.7000100

Example: A=7 + B=1

Farolim com pendural recto âmbar
 Side position lamp with holder straight
 Feu de position avec support jaune

PTOTAL
0,5W - 12V
1,1W - 24V



3182



A

0	•				
1		•			
2			•		
3				•	
4					•

B

CD

E

CLICK-IN

SUPERSEAL

Comprimento do Cabo
Cable Length
Longueur du Câble

Cor
Colour
Couleur

1	•	05	500mm	0	
2	•	35	3500mm	1	
8	•	50	5000mm	2	
				3	
				5	

3182. **A B C D E** 00

3182. **1 2 05 2** 00

Example: A=1 + B=2 + CD=05 + E=2

Farolim com pendural, conector click-in, cabo retangular com 500mm, vermelho
Rear position lamp with angled bracket, click-in connector, flat cable 500mm, red
Feu de position avec patte équerre, connectique click-in, câble plat 500mm, rouge

3157



PTOTAL
0,45W - 12V
1,0W - 24V



	A			
0	•	•	•	•
1				
2				
9				

	B				CD		E	
					Comprimento do Cabo Cable Length Longueur du Câble		Cor Colour Couleur	
0	•				05	500mm	0	○
1			•		35	3500mm	1	●
2		•			50	5000mm	2	●
8				•			3	●
							5	●

* Versão com conector não é bi-voltagem
* Lamps with connector are not dual-voltage
* Feu avec connectique ne sont pa bi-voltage

3157. **A B C D E** 00
↓ ↓ ↓ ↓ ↓
3157. **1 2 05 2 00**

Example: A=1 + B=2 + CD=05 + E=2

Farolim com pendural, conector click-in, cabo retangular com 500mm, vermelho
Rear position lamp with angled bracket, click-in connector, flat cable 500mm
Feu de position avec patte équerre, connectique click-in, câble plat 500mm, rouge

PTOTAL
0,45W - 12V
1,0W - 24V



3158



A

0	•	•	•	•
1		•		
2			•	
9				•

B

CD

E

		CLICK-IN		SUPERSEAL	Comprimento do Cabo Cable Length Longueur du Câble	Cor Colour Couleur
0	•				05 500mm	0 ○
1			•		35 3500mm	1 ●
2		•			50 5000mm	2 ●
8				•		3 ●
						5 ●

3158.ABCDE00
 ↓ ↓ ↓ ↓ ↓
 3158.1205200

Example: A=1 + B=2 + CD=05 + E=2

Farolim com pendural, conector click-in, cabo retangular com 500mm, vermelho
 Rear position lamp with angled bracket, click-in connector, flat cable 500mm
 Feu de position avec patte équerre, connectique click-in, câble plat 500mm, rouge

* Versão com conector não é bi-voltagem
 * Lamps with connector are not dual-voltage
 * Feu avec connectique ne sont pa bi-voltage

3141



PTOTAL
0,45W - 12V
1,0W - 24V



A

5	•		
6		•	
7			•

B

CD

E

CLICK-IN		SUPERSEAL		Comprimento do Cabo Cable Length Longueur du Câble	Cor Colour Couleur
1		•		05	500mm
2	•			35	3500mm
8			•	50	5000mm
0					
1					
2					
3					
5					

3141. **A B C D E** 00
 ↓ ↓ ↓ ↓ ↓
 3141. **6 2 05 2** 00

Example: A=6 + B=2 + CD=05 + E=2

Farolim com pendural curvo, conector click-in, cabo retangular com 500mm, vermelho
 Rear position lamp with angled bracket, click-in connector, flat cable 500mm, red
 Feu de position avec patte équerre, connectique click-in, câble plat 500mm, rouge

T10 5W



3141



A

0	•			
1		•		
2			•	
3				•

B

3141.A000B00
 ↓ ↓
 3141.2 0001 00

Example: A=2 + B=1

Farolim âmbar com pendural reto
 Side position lamp with holder straight
 Feu de position jaune avec support

	Cor Colour Couleur		Cor Colour Couleur
0	○	Vidro Lens Caboçon	○
1	●		●
2	●	3141.0000010	○
		3141.0000110	●
3	●	3141.0000210	●
		3141.0000310	●
5	●	3141.0000510	●

3129



C5W (11x36) SV 8.5



A

								Com proteção de borracha With rubber boot Avec protection en caoutchouc
3				•				
4					•			
5							•	
6						•		
7			•					
8		•						
9	•							

3129.A000B00

3129.6 0001 00

Example: A=6 + B=1

Farolim âmbar com pendural reto
Side position lamp with holder straight
Feu de position jaune avec support

B

	Cor Colour Couleur	Vidro Lens Cabochon	Cor Colour Couleur
0			
1		3129.0000010	
2		3129.0000110	
3		3129.0000210	
		3129.0000310	
5		3129.0000510	

C5W (11x36) SV 8.5



3148

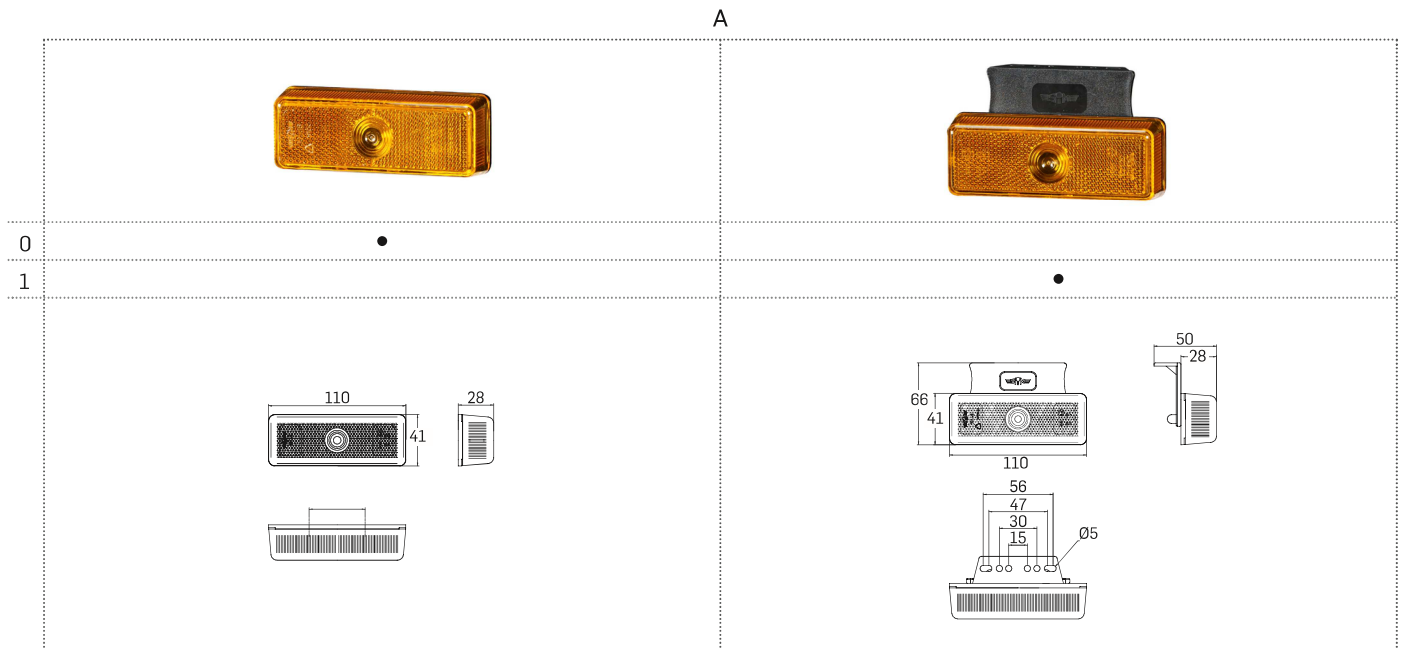

3148.**A**000**B**00
 ↓ ↓
 3148.**1** 000**2** 00

Example: A=1 + B=2

Farolim vermelho com pendural
 Rear position lamp with angled bracket
 Feu de position rouge avec patte équerre

	B		
	Cor Colour Couleur	Vidro Lens Caboçon	Cor Colour Couleur
0			
1		3148.0000110	
2		3148.0000110	
3		3148.0000210	
4		3148.0000310	
5		3148.0000510	

3168



PTOTAL
0,3W - 12V
0,5W - 24V



A

0	•	•
1	•	•
2	•	•

3168.ABCDE00
 ↓ ↓ ↓ ↓ ↓
 3168.0205200

Example: A=0 + B=2 + CD=05 + E=2

Farolim com conector click-in, cabo retangular com 500mm, vermelho
 Rear position lamp with click-in connector, flat cable 500mm, red
 Feu de position avec connectique click-in, câble plat 500mm, rouge

B			CD		E	
CLICK-IN	SUPERSEAL		Comprimento do Cabo Cable Length Longueur du Câble		Cor Colour Couleur	
			05	500mm	0	
1	•	•	35	3500mm	1	
2	•	•	50	5000mm	2	
8	•	•			5	

PTOTAL
0,3W - 12V
0,5W - 24V



3181



1LED - 15cd



3LED - 35cd



Articulado
Orientable
Orientable

A



3181. **A B C D E** 00
 ↓ ↓ ↓ ↓ ↓
 3168. **1 2 05 2** 00

Example: A=1 + B=2 + CD=05 + E=2

Farolim com pendural, conetor click-in, cabo retangular com 500mm, vermelho
 Rear position lamp with angled bracket, click-in connector, flat cable 500mm, red
 Feu de position avec patte équerre, connectique click-in, câble plat 500mm, rouge

B		CD		E	
CLICK-IN	SUPERSEAL	Comprimento do Cabo Cable Length Longueur du Câble		Cor Colour Couleur	
1	•	05	500mm	0	○ 1LED - 15cd
2	•	35	3500mm	1	●
8	•	50	5000mm	2	●
				9	○ 3LED - 35cd

3186



PTOTAL
0,5W - 12V
1,0W - 24V



A

0	•	•	•
1			
2			

B

CD

E

FG

	CLICK-IN	SUPERSEAL		Comprimento do Cabo Cable Length Longueur du Câble		Cor Colour Couleur		Voltagem Voltage Voltage
1			05	500mm	0		12	12V
2	•		35	3500mm	1		24	24V
8		•	50	5000mm	2			

3186. **A B C D E F G**
 ↓ ↓ ↓ ↓ ↓ ↓ ↓
 3186. **1 1 05 2 12**

Example: A=1 + B=1 + CD=05 + E=2 + FG=12

Farolim com cabo retangular com 500mm, vermelho de 12V
 Rear position lamp with flat cable 500mm and 12V
 Feu de position avec câble rectangulaire 500mm, rouge 12V

PTOTAL
0,4W - 12V
1,0W - 24V



3194

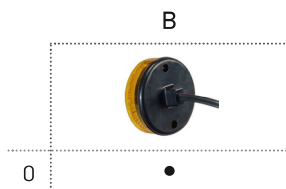

CD	
Comprimento do Cabo Cable Length Longueur du Câble	
05	500mm
35	3500mm
50	5000mm

E	
Cor Colour Couleur	
0	
1	
2	
3	
5	

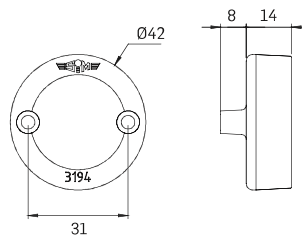

3194.0 **B** **C** **D** **E** 00
 ↓ ↓ ↓ ↓
 3194.0 **0** **05** **2** 00

Example: B=0 + CD=05 + E=2

Farolim com cabo 500mm, vermelho
 Rear position lamp, cable 500mm
 Feu de position, câble 500mm, rouge

3110



C5W (11x36) SV 8.5



A

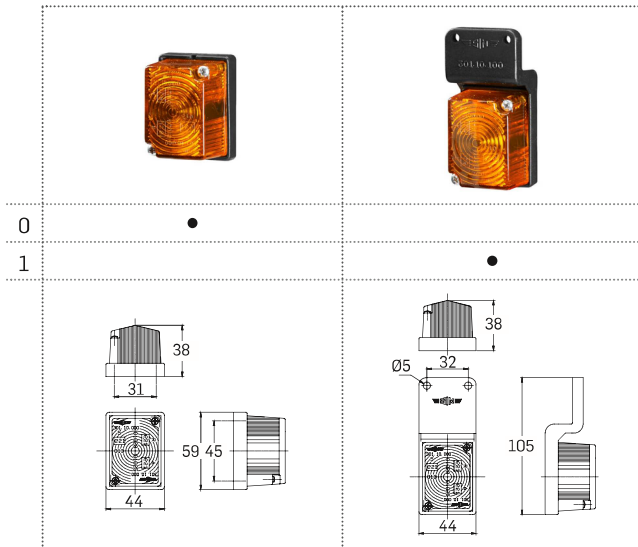

B

	Cor Colour Couleur	Vidro Lens Caboçon	Cor Colour Couleur
0			
1		3110.0000010	
2		3110.0000110	
3		3110.0000210	
4		3110.0000310	
5		3110.0000410	
		3110.0000510	

3110.A000B00

3110.1 0001 00

Example: A=1 + B=1

Farolim com pendural reto âmbar
Side position lamp with angled straight
Feu de position avec support jaune



Referência Part N° Référence	Cor Colour Couleur
3110.2000000	
3110.2000200	

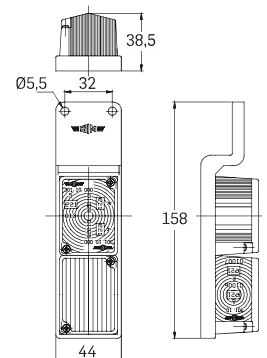

C5W (11x36) SV 8.5



3130

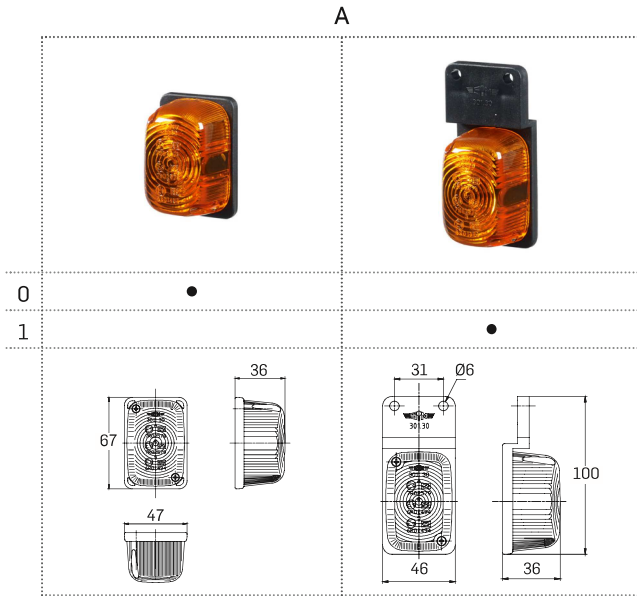

B

	Cor Colour Couleur	Vidro Lens Caboçon	Cor Colour Couleur
0			
1		3130.0000010	
2		3130.0000110	
3		3130.0000210	
4		3130.0000310	
5		3130.0000410	
		3130.0000510	

3130.A000B00
 ↓ ↓
 3130.1 0001 00

Example: A=1 + B=1

Farolim com pendural reto âmbar
 Side position lamp with angled straight
 Feu de position avec support jaune

C5W (11x36) SV 8.5



3120

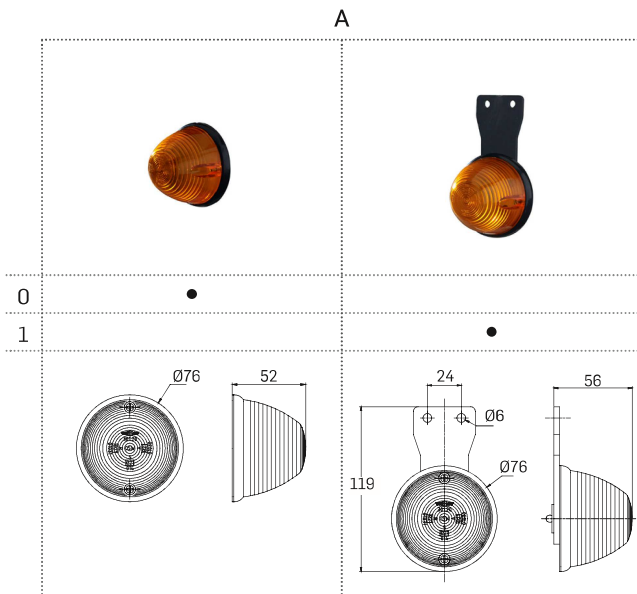

B

	Cor Colour Couleur	Vidro Lens Caboçon	Cor Colour Couleur
0			
1		3120.0000010	
2		3120.0000110	
3		3120.0000210	
4		3120.0000310	
5		3120.0000510	

3120.A000B00
 ↓ ↓
 3120.1 0001 00

Example: A=1 + B=1

Farolim com pendural reto âmbar
 Side position lamp with angled straight
 Feu de position avec support jaune

3146



Referência Part N° Référence	Cor Colour Couleur
3146.0000000	○
3146.0000100	●
3146.0000200	●
3146.0000300	●
3146.0000400	●
3146.0000500	●

C5W (11x36) SV 8.5

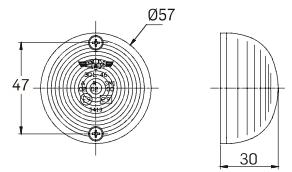

Referência Part N° Référence	Cor Colour Couleur
3146.1000000	○
3146.1000100	●
3146.1000200	●
3146.1000300	●
3146.1000400	●
3146.1000500	●

Vidro Lens Cabochon	Cor Colour Couleur
3146.0000010	○
3146.0000110	●
3146.0000210	●
3146.0000310	●
3146.0000410	●
3146.0000510	●

C5W (11x36) SV 8.5

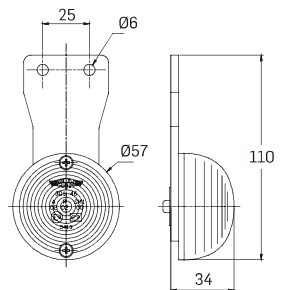

3147



Referência Part N° Référence	Cor Colour Couleur
3147.0000000	○
3147.0000100	●
3147.0000200	●
3147.0000300	●
3147.0000400	●
3147.0000500	●

C5W (11x36) SV 8.5

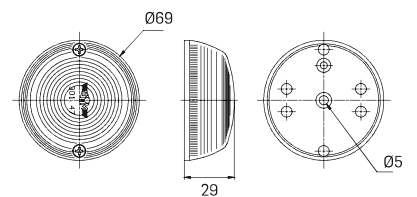

Referência Part N° Référence	Cor Colour Couleur
3147.1000000	○
3147.1000100	●
3147.1000200	●
3147.1000300	●
3147.1000400	●
3147.1000500	●

Vidro Lens Cabochon	Cor Colour Couleur
3147.0000010	○
3147.0000110	●
3147.0000210	●
3147.0000310	●
3147.0000410	●
3147.0000510	●

C5W (11x36) SV 8.5

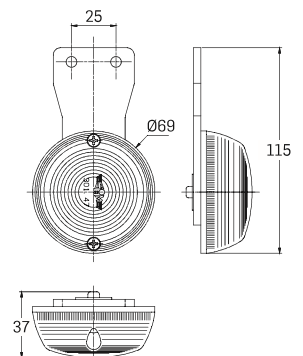

PTOTAL
1,2W - 12V
2,7W - 24V



3199

NEWPRODUCT



B		CD	
CLICK-IN	SUPERSEAL	Comprimento do Cabo Cable Length Longueur du Câble	
1	•	05	500mm
2	•	35	3500mm
8	•	50	5000mm

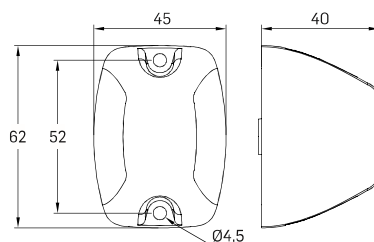

3199.0 **BCD** 0 00

3199.0 **1 05** 0 00

Example: B=1 + CD=05

Delimitador cabo retangular com 500mm
Outline lamp with flat cable 500mm
Feu de gabarit avec câble rectangulaire 500mm

3168



PTOTAL
0.6W - 12V
1.6W - 24V



Referência Part N° Référence	Cor Colour Couleur
3168.4105400	
3168.4105800	
3168.4105900	

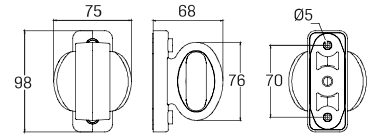

Referência Part N° Référence	Cor Colour Couleur
3168.6105400	
3168.6105800	
3168.6105900	

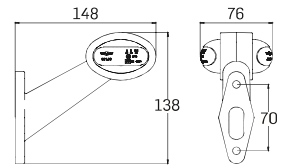

Referência Part N° Référence	Cor Colour Couleur
3168.8105400	
3168.8105800	
3168.8105900	

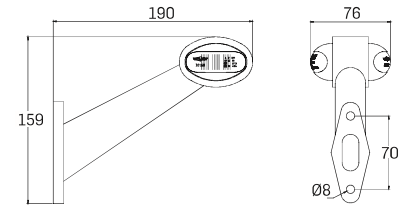

Referência Part N° Référence	Cor Colour Couleur
3168.5105400	
3168.5105800	
3168.5105900	

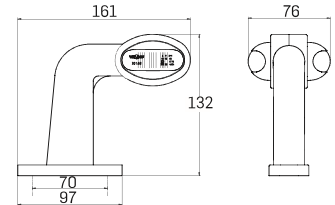

Referência Part N° Référence	Cor Colour Couleur
3168.7105400	
3168.7105800	
3168.7105900	

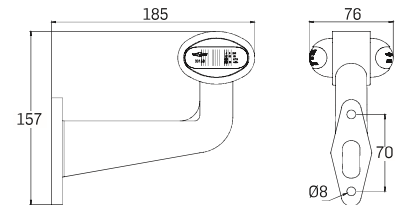

Referência Part N° Référence	Cor Colour Couleur
3168.3105000	

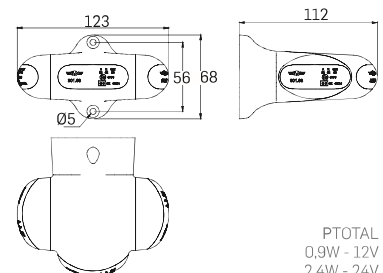

PTOTAL
0.9W - 12V
2.4W - 24V

PTOTAL
1.5W - 12V
3.3W - 24V



3174

NEWPRODUCT

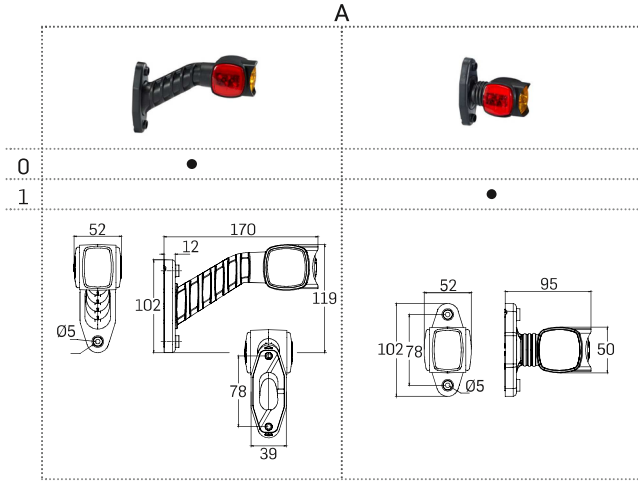

B		CD	E	
CLICK-IN	SUPERSEAL	Comprimento do Cabo Cable Length Longueur du Câble	Esquerdo Left Gauche	Direito Right Droit
1	•	05 500mm	0	•
2	•	35 3500mm	1	•
8	•	50 5000mm		

3174. **A B C D E** 00
↓ ↓ ↓ ↓ ↓
3174. **0 2 0 5 1** 00

Example: A=0 + B=2 + CD=05 + E=1

Delimitador direito 170mm com conector click-in, cabo retangular com 500mm
Outline right 170mm lamp with click-in connector, flat cable 500mm
Feu de gabarit droit 170mm avec connectique click-in, câble plat 500mm

4W BA 9s



3170

NEWPRODUCT

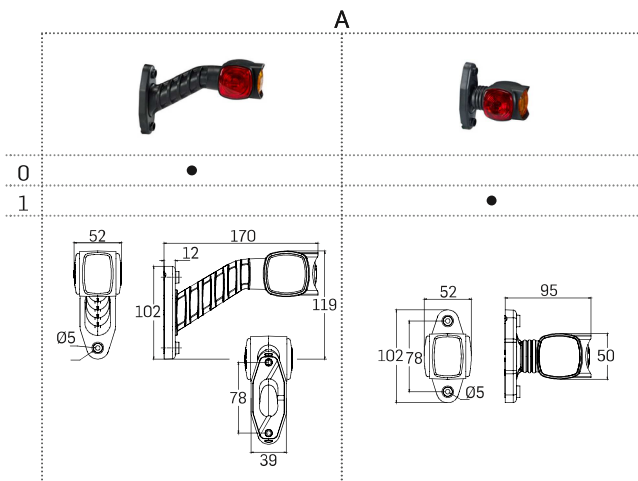

B		CD	E		FG
CLICK-IN	SUPERSEAL	Comprimento do Cabo Cable Length Longueur du Câble	Esquerdo Left Gauche	Direito Right Droit	Voltagem Voltage Voltage
1	•	05 500mm	0	•	02 12V
2	•	35 3500mm	1	•	04 24V
8	•	50 5000mm			

3170. **A B C D E F G**
↓ ↓ ↓ ↓ ↓ ↓ ↓
3170. **0 2 0 5 1 0 4**

Example: A=0 + B=2 + CD=05 + E=1 + FG=04

Delimitador direito 170mm com conector click-in, cabo retangular com 500mm, 24V
Outline right 170mm lamp with click-in connector, flat cable 500mm, 24V
Feu de gabarit droit 170mm avec connectique click-in, câble rectangulaire 500mm, 24V

3119



P 21/5W BAY 15d

R 5W BA 15s



Referência Part N° Référence	Cor Colour Couleur
3119.1000000	
3119.1000300	pos - stop
3119.1000800	
3119.1000900	

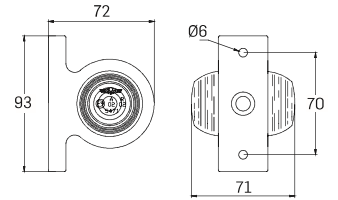

Referência Part N° Référence	Cor Colour Couleur
3119.6000000	
3119.6000800	
3119.6000900	

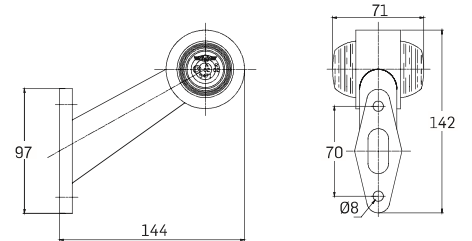

Referência Part N° Référence	Cor Colour Couleur
3119.2000000	
3119.2000800	
3119.2000900	

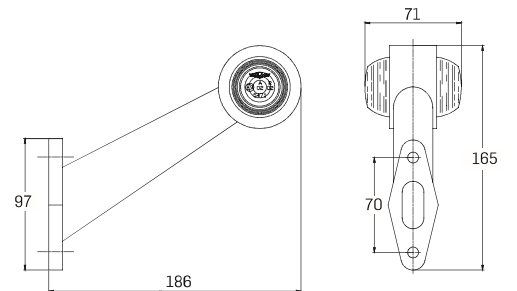

Referência Part N° Référence	Cor Colour Couleur
3119.5000000	
3119.5000800	
3119.5000900	

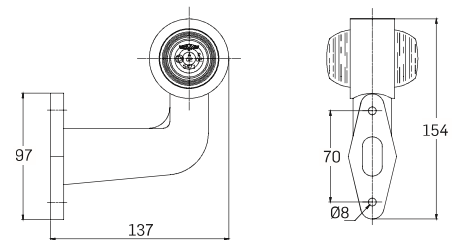

Referência Part N° Référence	Cor Colour Couleur	Vidro Lens Cabochon	Cor Colour Couleur
3119.0000000			
3119.0000800			
3119.0000900			

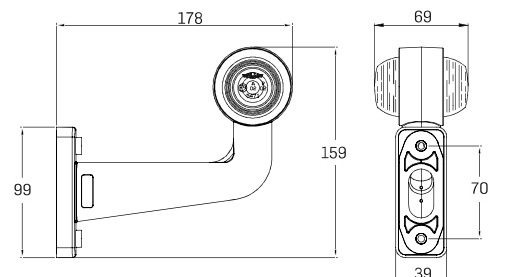

PTOTAL
0,8W - 12V
2,0W - 24V



3119

NEW PRODUCT



A

0				
1	•			
2		•		
5			•	
6		•		

	B			CD		E		F	
				Comprimento do Cabo Cable Length Longueur du Câble	Cor Colour Couleur		Esquerdo Left Gauche	Direito Right Droit	
1	•			05	500mm		1	•	
2		•		35	3500mm		2		
8			•	50	5000mm			•	

3119. **A B C D E F 9**
 ↓ ↓ ↓ ↓ ↓ ↓ ↓
 3119. **1 2 05 019**

Example: A=1 + B=2 + CD=05 + E=0 + F=1

Delimitador com pendural, conector click-in, cabo retangular com 500mm, vermelho e branco, esquerdo
 Outline lamp with angled bracket, click-in connector, flat cable 500mm, red and white, left
 Feu de gabarit avec patte équerre, connectique click-in, câble plat 500mm, rouge et blanc, gauche

3144

Iluminação interior
Interior lamp
Plafonier



BA 15s



Referência	Interruptor
Part N°	Switch
Référence	Interrupteur

3144.0000000	
3144.0000900	•

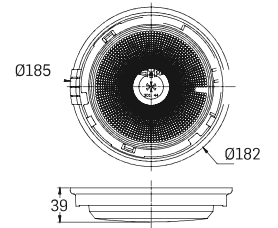

Referência	Interruptor
Part N°	Switch
Référence	Interrupteur

3144.1000000	
3144.1000900	•

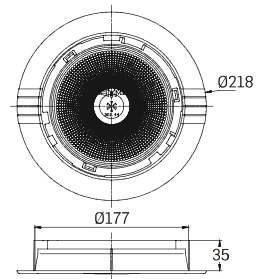

Referência	Interruptor
Part N°	Switch
Référence	Interrupteur

3144.2000000	
3144.2000900	•

Vidro	Interruptor
Lens	Switch
Cabochon	Interrupteur

3144.0000010	
3144.0000910	•

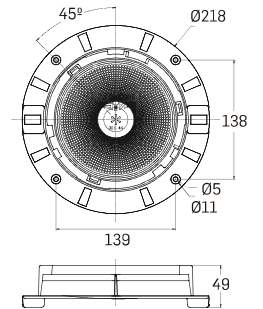

3115

Iluminação interior
Interior lamp
Plafonier



P 21W BA 15s



Referência	Interruptor
Part N°	Switch
Référence	Interrupteur

3115.0000000	
3115.0000900	•

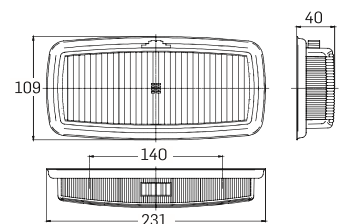

Referência	Vidro (PC)
Part N°	Lens (PC)
Référence	Cabochon (PC)

3115.1000000	3115.0000010
--------------	--------------

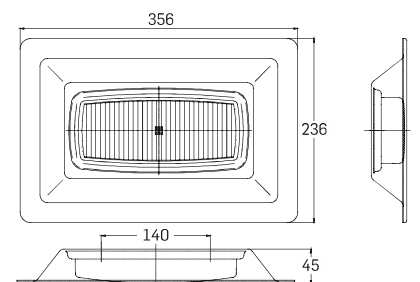

PTOTAL
2,1W - 12/24V



Iluminação interior
Interior lamp
Plafonnier

3191

NEWPRODUCT

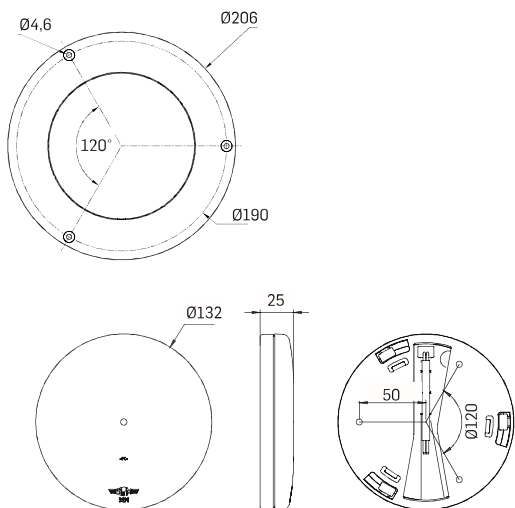

Referência Part N° Référence	Interruptor Switch Interrupteur	Para encastrar Recessed base A encastrer
------------------------------------	---------------------------------------	--

3191.0105000		
3191.0105900	•	
3191.1105000		•
3191.1105900	•	•

Com cabo 500mm, disponíveis outros comprimentos de cabo; consulte-nos!
With cable 500mm , available other length of cables; please check with us!
Avec cable 500mm , d'autres longueurs de câble possibles; merci nos consulter!

PTOTAL
6,0W - 12/24V



Iluminação interior
Interior lamp
Plafonnier

3171

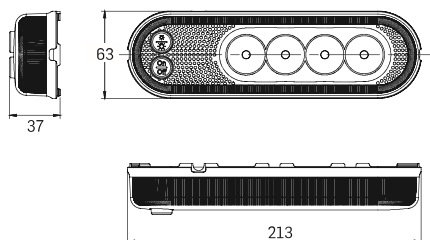

Referência Part N° Référence	Cor Colour Couleur	Interruptor Switch Interrupteur
------------------------------------	--------------------------	---------------------------------------

3171.0000000	○	
3171.0000900	○	•
3171.5000000	●	
3171.5000900	●	•

3131



PTOTAL
1,9W - 12V
3,9W - 24V

28 LED's



Referência Part N° Référence	Cor Colour Couleur	Voltagem Voltage Voltage
3131.0025012	○	12V
3131.0025024	○	24V
3131.0025212	●	12V
3131.0025224	●	24V

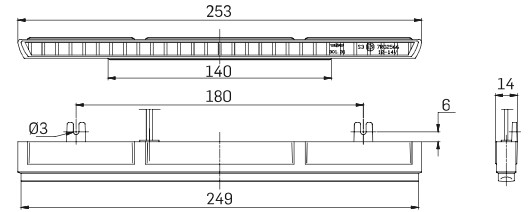

Referência Part N° Référence	Cor Colour Couleur	Voltagem Voltage Voltage
3131.5025012	○	12V
3131.5025024	○	24V
3131.5025212	●	12V
3131.5025224	●	24V

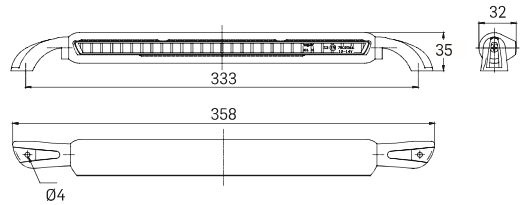

28 LED's

3133



PTOTAL
1,9W - 12V
3,9W - 24V

28 LED's



Referência Part N° Référence	Cor Colour Couleur	Voltagem Voltage Voltage
3133.0025012	○	12V
3133.0025024	○	24V
3133.0025212	●	12V
3133.0025224	●	24V

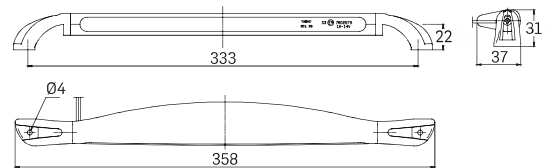

3134



P 21W



Referência Part N° Référence
3134.0000212

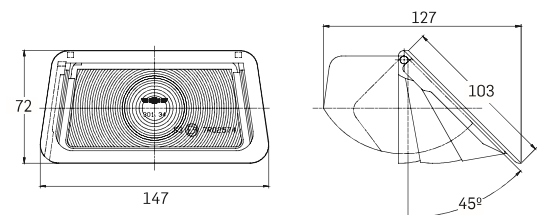

PTOTAL
1.9W - 12V
3.9W - 24V



3136

28 LED's

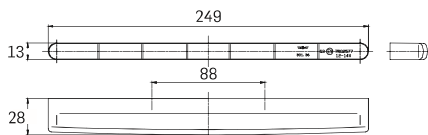

Referência Part N° Référence	Cor Colour Couleur	Voltagem Voltage Voltage
3136.0025012	○	12V
3136.0025024	○	24V
3136.0025212	●	12V
3136.0025224	●	24V

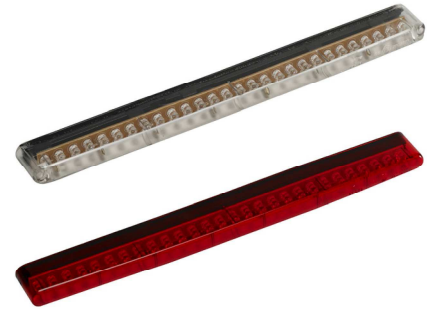

28 LED's

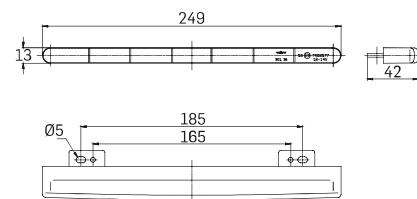

Referência Part N° Référence	Cor Colour Couleur	Voltagem Voltage Voltage
3136.1025012	○	12V
3136.1025024	○	24V
3136.1025212	●	12V
3136.1025224	●	24V

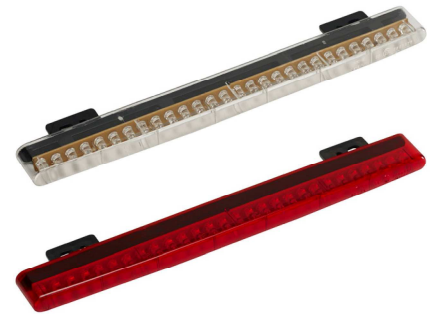

28 LED's

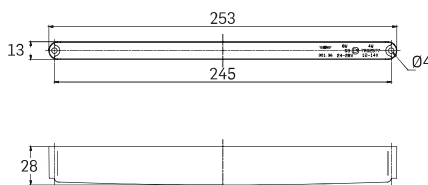

Referência Part N° Référence	Cor Colour Couleur	Voltagem Voltage Voltage
3136.2025012	○	12V
3136.2025024	○	24V
3136.2025212	●	12V
3136.2025224	●	24V

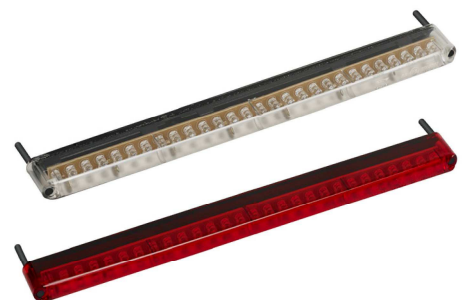

28 LED's

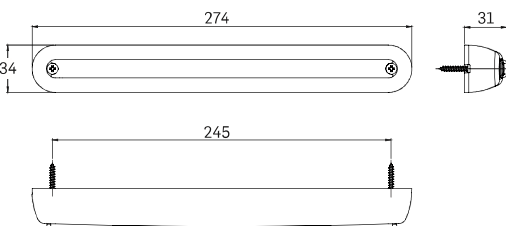

Referência Part N° Référence	Cor Colour Couleur	Voltagem Voltage Voltage
3136.3025012	○	12V
3136.3025024	○	24V
3136.3025212	●	12V
3136.3025224	●	24V



3137



PTOTAL
1,6W - 12V
3,4W - 24V

24 LED's



Referència Part N° Référence	Cor Colour Couleur	Voltagem Voltage Voltage
3137.5025012	○	12V
3137.5025024	○	24V
3137.5025212	●	12V
3137.5025224	●	24V
3137.5025512	●	12V
3137.5025524	●	24V

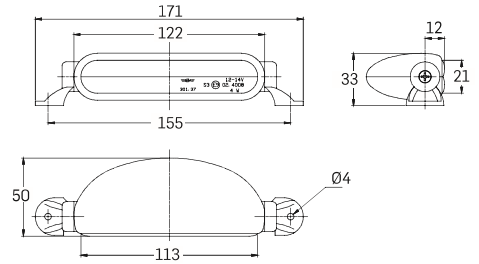

3135



PTOTAL
1,9W - 12V
3,9W - 24V

28 LED's



Referència Part N° Référence	Cor Colour Couleur	Voltagem Voltage Voltage
3135.5025012	○	12V
3135.5025024	○	24V
3135.5025212	●	12V
3135.5025224	●	24V

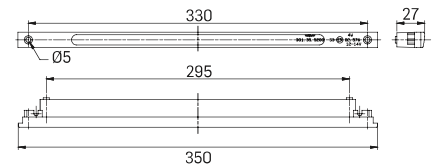

Referència Part N° Référence	Cor Colour Couleur	Voltagem Voltage Voltage
3135.6025012	○	12V
3135.6025024	○	24V
3135.6025212	●	12V
3135.6025224	●	24V

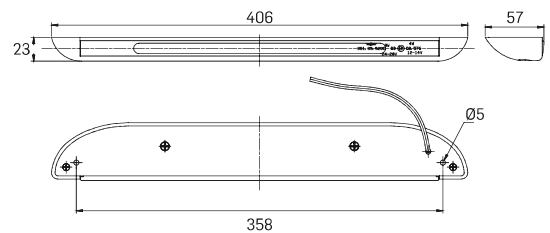

PTOTAL
0,5W - 12V
1,1W - 24V



Iluminação chapa de matrícula
Registration plate light
Éclairage de plaque

3108

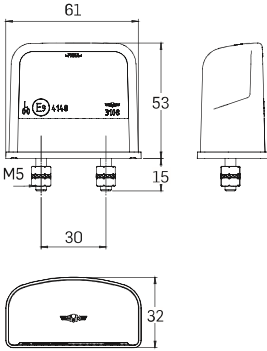

B		CD	
CLICK-IN	SUPERSEAL	Comprimento do Cabo Cable Length Longueur du Câble	
1	•	05	500mm
2	•	35	3500mm
8	•	50	5000mm

3108.0 **B** **CD** 000

3108.0 **2 05** 000

Example: B=2 + CD=05

Farolim de iluminação chapa de matrícula, conetor click-in, cabo retangular com 500mm.
Registration plate light, click-in connector, flat cable 500mm.
Éclairage de plaque, connectique click-in, câble plat 500mm.

PTOTAL
0,3W - 12V
0,8W - 24V



Iluminação chapa de matrícula
Registration plate light
Éclairage de plaque

3168

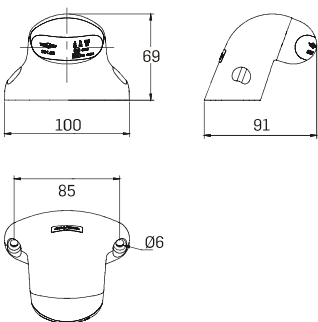

B		CD	
CLICK-IN	SUPERSEAL	Comprimento do Cabo Cable Length Longueur du Câble	
1	•	05	500mm
2	•	35	3500mm
8	•	50	5000mm

3168.9 **B** **CD** 000

3168.9 **2 05** 000

Example: B=2 + CD=05

Farolim de iluminação chapa de matrícula, conetor click-in, cabo retangular com 500mm.
Registration plate light, click-in connector, flat cable 500mm.
Éclairage de plaque, connectique click-in, câble plat 500mm.

3104

Iluminação chapa de matrícula
Registration plate light
Éclairage de plaque



10W BA 15s



Referência Part N° Référence	Cor Colour Couleur
3104.0000000	●
3104.0000200	●

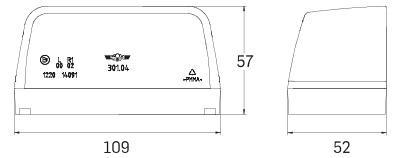
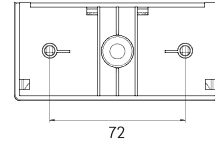

3107

Iluminação chapa de matrícula
Registration plate light
Éclairage de plaque



C5W (11x36) SV 8.5



Referência Part N° Référence	Material Material Matériel
3107.0000000	PVC
3107.5000000	PP

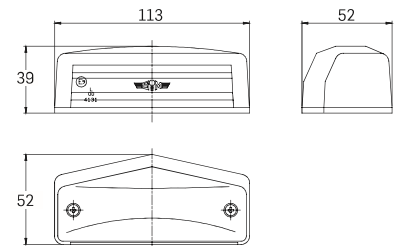

Iluminação chapa de matrícula + presença
Registration plate light + rear position
Éclairage de plaque + veilleuse

Referência Part N° Référence	Material Material Matériel
3107.0000200	PMMA

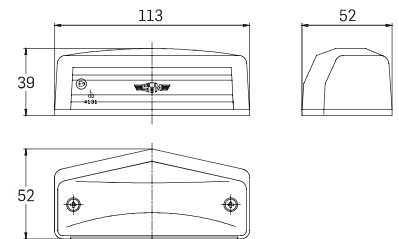

3112



C5W (11x36) SV 8.5



Referência Part N° Référence	Cor Colour Couleur
3112.0000800	○
3112.0000500	●

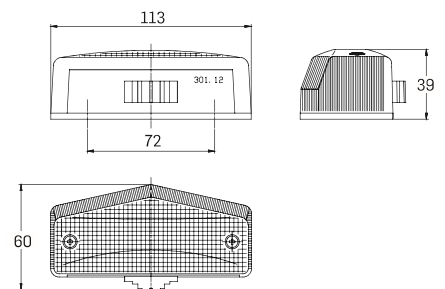

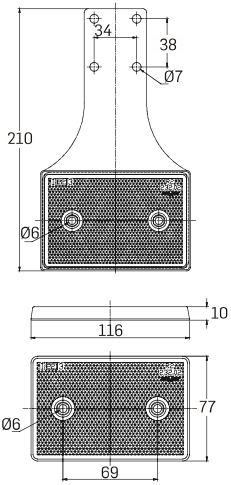

Referência Part N° Référence	Cor Colour Couleur	Adesivo Adhesive Adhésif	Pendural Pendant Bracket Support
3002.0000000	○	●	
3002.0000100	●	●	
3002.0000200	●	●	
3002.1000000	○		
3002.1000100	●		
3002.1000200	●		
3002.2000100	●		●
3002.2000200	●		●

E

3002

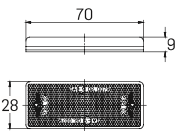

Referência Part N° Référence	Cor Colour Couleur	Adesivo Adhesive Adhésif
3003.0000000	○	●
3003.0000100	●	●
3003.0000200	●	●

E

3003

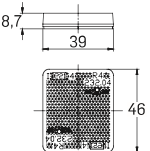
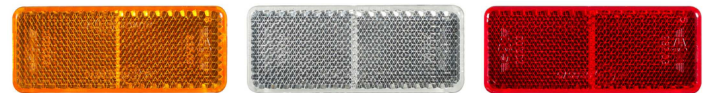

Referência Part N° Référence	Cor Colour Couleur	Adesivo Adhesive Adhésif
3004.0000000	○	●
3004.0000100	●	●
3004.0000200	●	●

E

3004

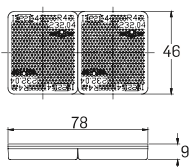

Referência Part N° Référence	Cor Colour Couleur	Adesivo Adhesive Adhésif
3004.2000000	○	●
3004.2000100	●	●
3004.2000200	●	●

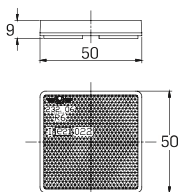
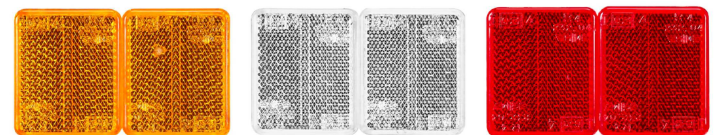

Referência Part N° Référence	Cor Colour Couleur	Adesivo Adhesive Adhésif
3006.0000000	○	●
3006.0000100	●	●
3006.0000200	●	●

E

3006



3007

(E)

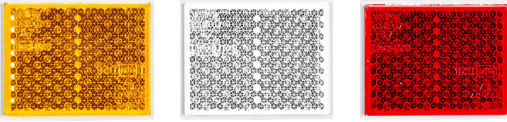

Referència Part N° Référence	Cor Colour Couleur	Adesivo Adhesive Adhésif
3007.0000000	○	●
3007.0000100	●	●
3007.0000200	●	●

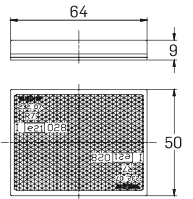

3009

(E)



Referència Part N° Référence	Cor Colour Couleur	Adesivo Adhesive Adhésif	Pendural Pendant Bracket Support
3009.0000000	○	●	
3009.0000100	●	●	
3009.0000200	●	●	
3009.1000000	○	●	
3009.1000100	●	●	
3009.1000200	●	●	
3009.2000100	●	●	●
3009.2000200	●	●	●

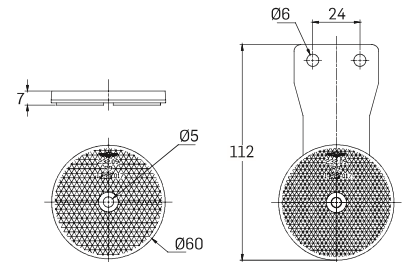

3010

(E)

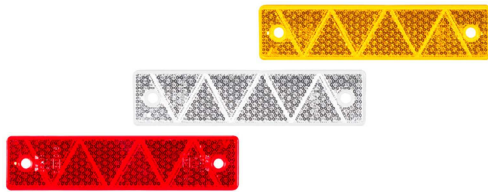

Referència Part N° Référence	Cor Colour Couleur	Adesivo Adhesive Adhésif
3010.0000000	○	●
3010.0000100	●	●
3010.0000200	●	●
3010.1000000	○	●
3010.1000100	●	●
3010.1000200	●	●

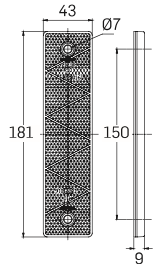

3011



Referència Part N° Référence	Cor Colour Couleur	Adesivo Adhesive Adhésif
3011.0000000	○	●
3011.0000100	●	●
3011.0000200	●	●

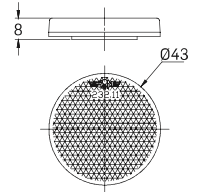

3012

(E)

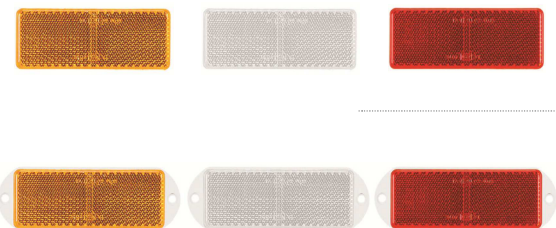

Referència Part N° Référence	Cor Colour Couleur	Adesivo Adhesive Adhésif
3012.0000000	○	●
3012.0000100	●	●
3012.0000200	●	●

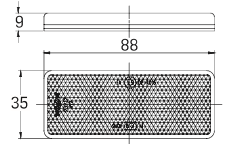

Referència Part N° Référence	Cor Colour Couleur	Furo Hole Trou
3012.1000000	○	●
3012.1000100	●	●
3012.1000200	●	●

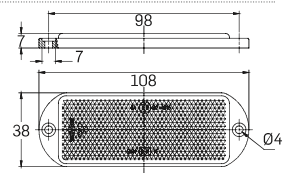

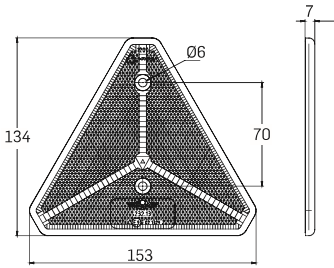

Referência Part N° Référence	Cor Colour Couleur
3013.1000200	●

E 3013

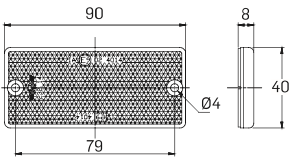
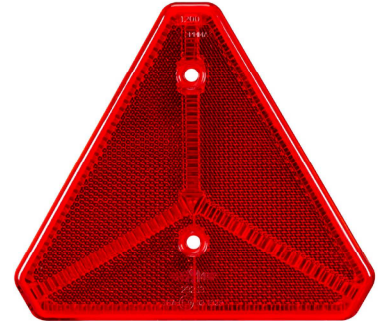

Referência Part N° Référence	Cor Colour Couleur	Adesivo Adhesive Adhésif
3014.0000000	○	●
3014.0000100	●	●
3014.0000200	●	●
3014.1000000	○	●
3014.1000100	●	●
3014.1000200	●	●

E 3014

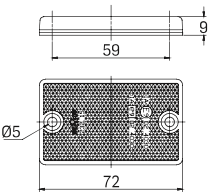
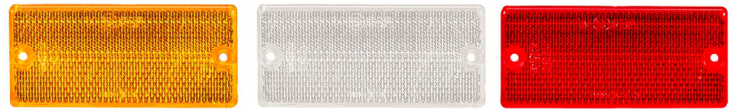

Referência Part N° Référence	Cor Colour Couleur	Adesivo Adhesive Adhésif
3015.0000000	○	●
3015.0000100	●	●
3015.0000200	●	●
3015.1000000	○	●
3015.1000100	●	●
3015.1000200	●	●

E 3015

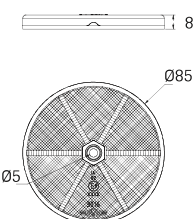
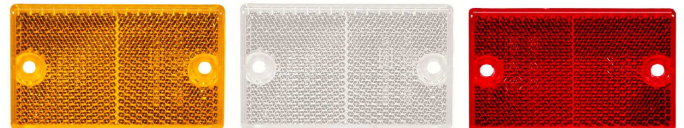

Referência Part N° Référence	Cor Colour Couleur	Adesivo Adhesive Adhésif
3016.0000000	○	●
3016.0000100	●	●
3016.0000200	●	●
3016.1000000	○	●
3016.1000100	●	●
3016.1000200	●	●

E 3016

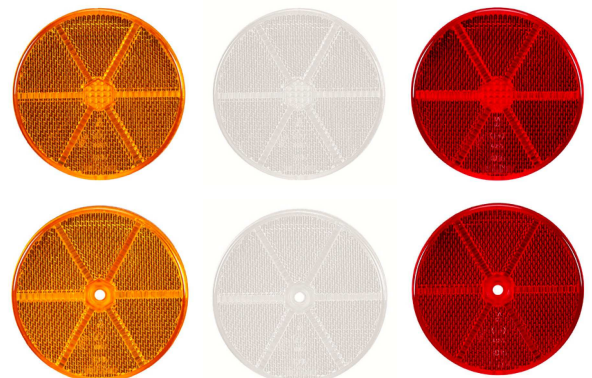

3092
3096
3097
3098



3.236.05.0025

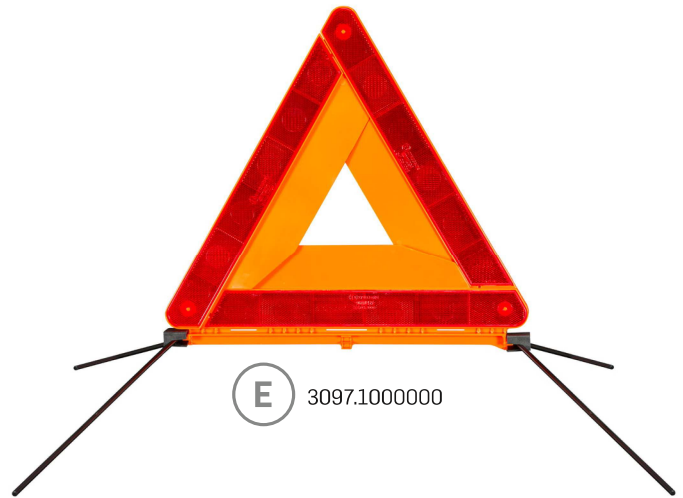

DIN 11030/TPESC

Painel P2 - 425mm x 425mm



3092.1000001



3092.1000000

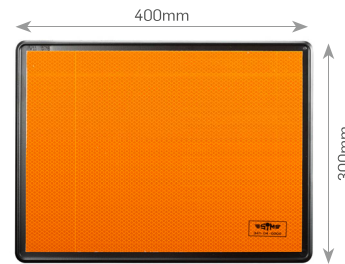

E 3096.0000000

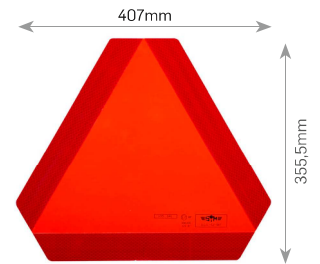

E 3098.0000000

3.19

Telas retrorrefletoras
Retro-reflective markings
Marqueurs rétro-réfléchissants

UNECE 104



Referência Part N° Référence	Cor Colour Couleur	Comprimento Length Longeur
------------------------------------	--------------------------	----------------------------------

3.19.0000048	○	50mt
3.19.0000049	●	50mt
3.19.0000050	●	50mt

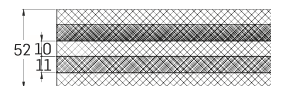

Referência Part N° Référence	Cor Colour Couleur	Comprimento Length Longeur
------------------------------------	--------------------------	----------------------------------

3.19.0000051	○	50mt
3.19.0000052	●	50mt
3.19.0000053	●	50mt

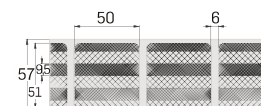

REG. 70 ECE/ONU (E)

3095

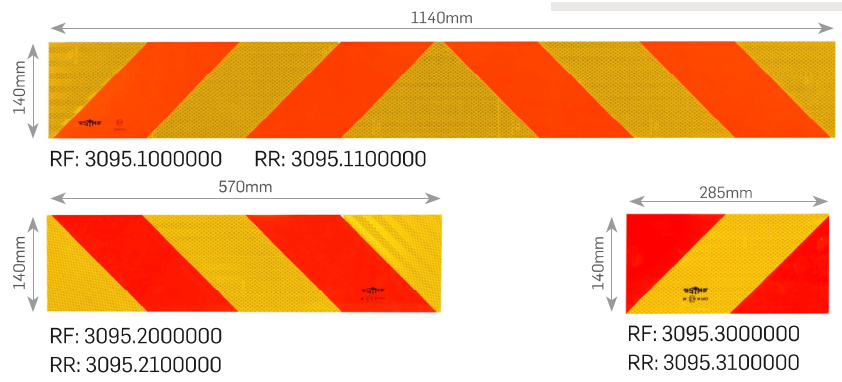

REG. 70 ECE/ONU (E)

3094

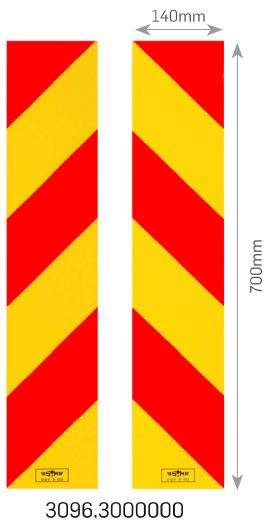
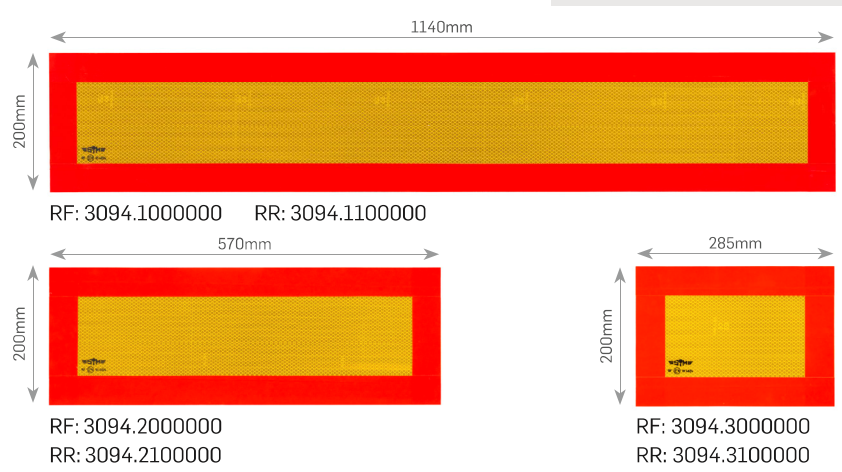

DGV - PORTUGAL

3096

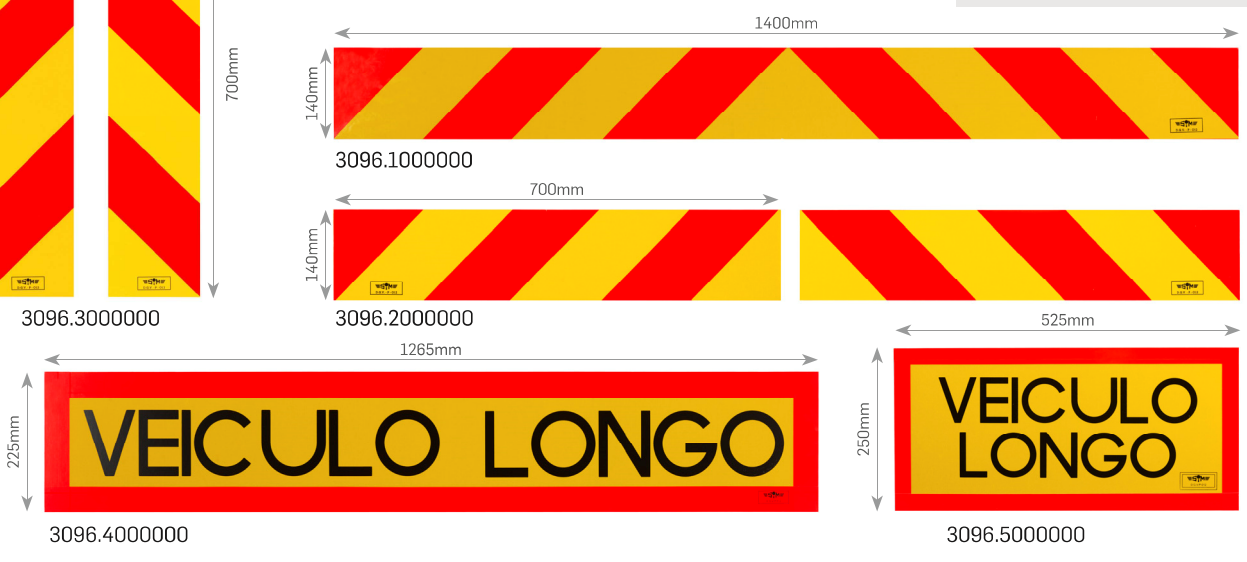

4192



Referência Part N° Référence	Cor Colour Couleur	Lâmpada Bulb Ampoule	Volt Volt Volt
4192.0000012	●	BA 15s	12V
4192.0000112	●	H3	12V
4192.0000512	●	BA 15s	12V
4192.0000612	●	H3	12V
4192.0000024	●	BA 15s	24V
4192.0000124	●	H3	24V
4192.0000524	●	BA 15s	24V
4192.0000624	●	H3	24V

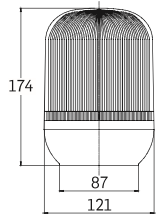

4193



Referência Part N° Référence	Cor Colour Couleur	Lâmpada Bulb Ampoule	Volt Volt Volt
4193.0000012	●	BA 15s	12V
4193.0000112	●	H3	12V
4193.0000512	●	BA 15s	12V
4193.0000612	●	H3	12V
4193.0000024	●	BA 15s	24V
4193.0000124	●	H3	24V
4193.0000524	●	BA 15s	24V
4193.0000624	●	H3	24V

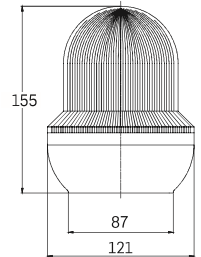

499.01

Suportes vários para aplicação
Different supports to apply
Différents supports pour application

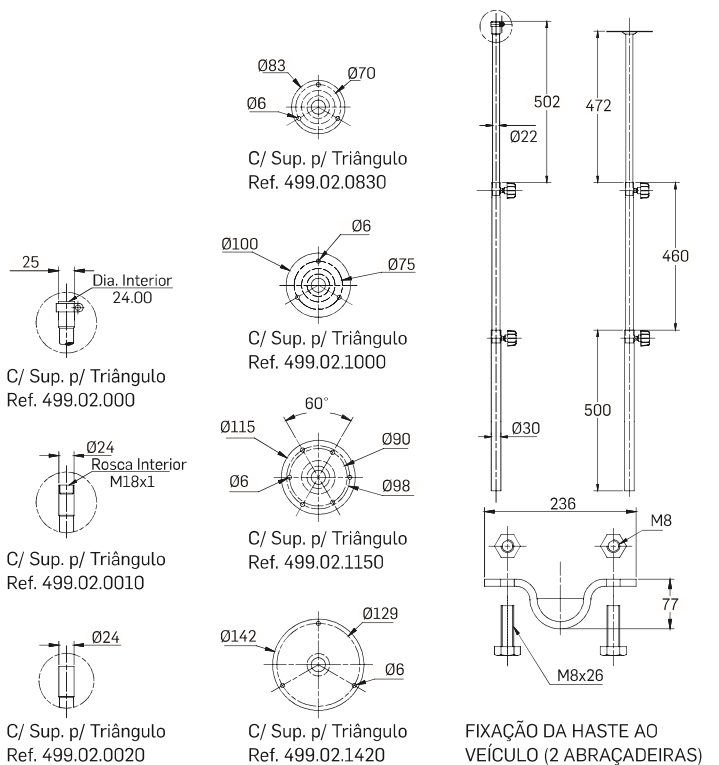

PTOTAL
2,3W - 12V
9,5W - 24V



Farolim de Emergência cat.X
Warning lamp cat.X
Feux special d'avertissement cat.X

3189

NEWPRODUCT

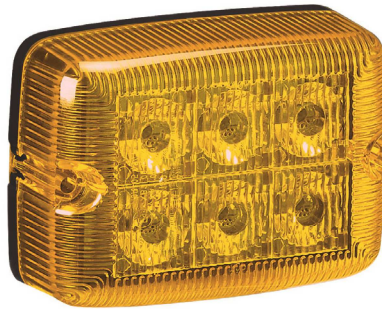
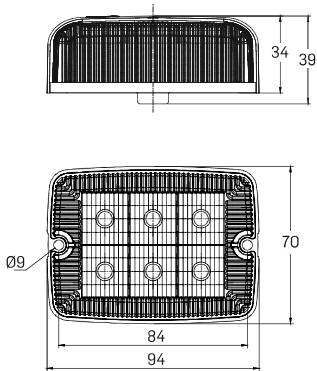

B			CD		E	
CLICK-IN	SUPERSEAL		Comprimento do Cabo Cable Length Longueur du Câble		Cor Colour Couleur	
1			05	500mm	1	
2			35	3500mm	5	
8			50	5000mm		

3189.0 **BCDE**00
↓ ↓ ↓ ↓
3189.0 **2 05 1 00**

Example: B=2 + CD=05 + E=1

Farolim de Emergência cat.X com conector click-in,
cabo retangular com 500mm, âmbar
Warning lamp cat.X with click-in connector,
flat cable 500mm, âmbar
Feux special d'avertissement cat.X avec
connectique click-in, câble plat 500mm, âmbar

PTOTAL
2,5W - 12/24V



Farolim de Circulação Diurna
Daytime running lamp
Feux-circulation diurne

3187

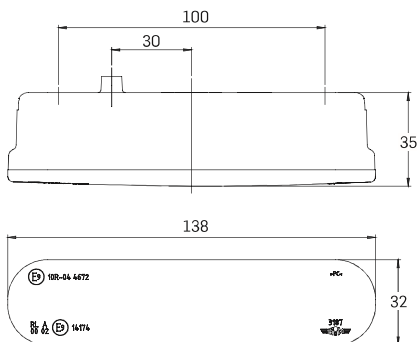

Referência
Part N°
Référence
3187.0305000

Com cabo 500mm, disponíveis outros comprimentos de cabo; consulte-nos!
With cable 500mm, available other length of cables; please check with us!
Avec cable 500mm, d'autres longueurs de câble possibles; merci nos consulter!

3227

Longo Alcance
Long Distance
Longue Portée



PTOTAL
2,3W - 12/24V

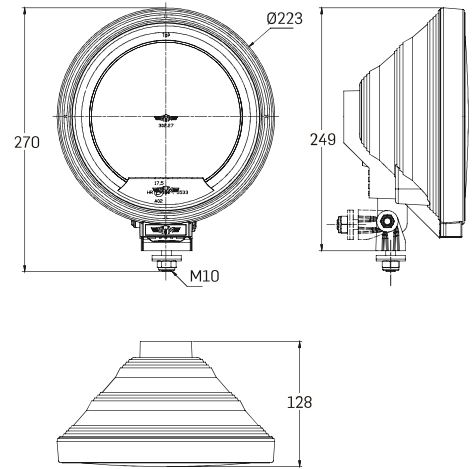

Referência Part N° Référence	Vidro Lens Cabochon	Lâmpada Bulb Ampoule
3227.0000000	○	H1 + T10
3227.0000500	●	H1 + T10
3227.1000000	○	H1 + LED
3227.1000500	●	H1 + LED



Capa de proteção para farol
Protective cover for driving lamps
Cache de protection phare

Referência Part N° Référence
3227.0000990

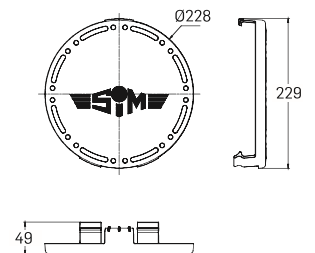

H1
PTOTAL
2,3W - 12/24V



PENCIL

3228

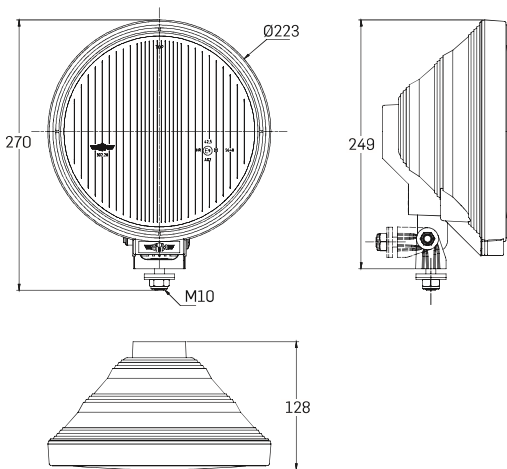

Referência Part N° Référence	Vidro Lens Cabochon	Lâmpada Bulb Ampoule
3228.0000000	○	H1 + T10
3228.0000500	●	H1 + T10
3228.1000000	○	H1 + LED
3228.1000500	●	H1 + LED

Capa de proteção para farol
Protective cover for driving lamps
Cache de protection phare

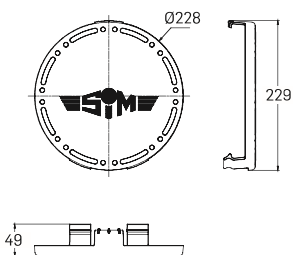

Referência Part N° Référence
3227.0000990

3225

Nevoeiro
Fog
Anti-brouillard

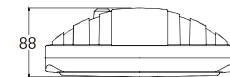
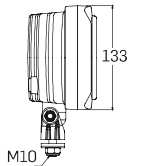
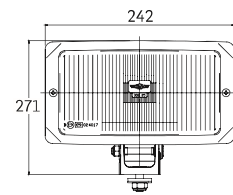
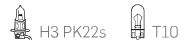

Referência	Com capa
Part N°	With cover
Référence	Avec Couvercle
.....	
3225.0000000	
3225.0000500	<input checked="" type="checkbox"/>

3226

Longo Alcance
Long Distance
Longue Portée

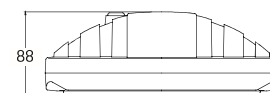
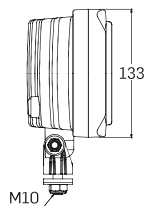
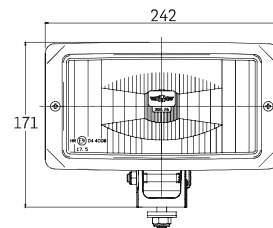
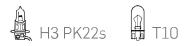

Referência	Com capa
Part N°	With cover
Référence	Avec Couvercle
.....	
3226.0000000	
3226.0000500	<input checked="" type="checkbox"/>

H3 PK 22s

PTOTAL
0,3W - 12V
0,6W - 24V



Longo Alcance
Long Distance
Longue Portée

3229

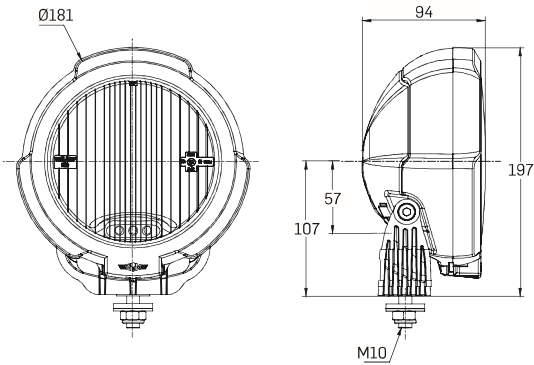

Referência Part N° Référence	Presença LED Position LED Veilleuse LED	Sem Presença Without Position Sans Veilleuse	Aro Cromado Chromium Plated Chromé	Aro Preto Black Noir
3229.1001000	•		•	
3229.1000000	•			•
3229.0001000		•	•	
3229.0000000		•		•

H3 PK 22s



3210

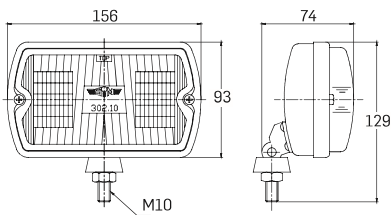

Referência Part N° Référence	Inox Stainless Steel Acier Inoxydable
3210.0000000	
3210.5000000	•



H3 PK 22s



3211

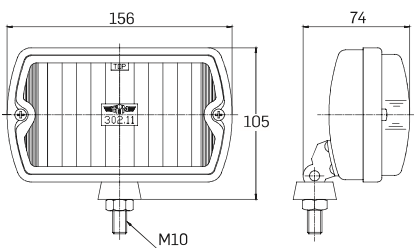

Referência Part N° Référence	Inox Stainless Steel Acier Inoxydable
3211.0000000	
3211.5000000	•



3218



Referência
Part N°
Référence

3218.0000000

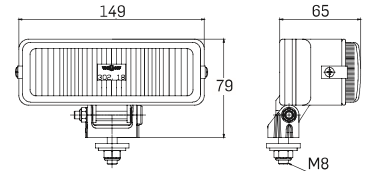

H3 PK22s

3220



Referência
Part N°
Référence

3220.0000000

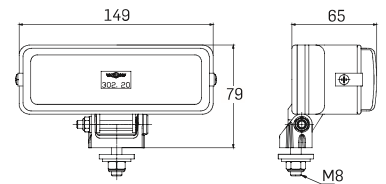

H3 PK22s

3212

Carcaça de borracha
Rubber housing
Cuvelage caoutchouc



Referência
Part N°
Référence

3212.9000000

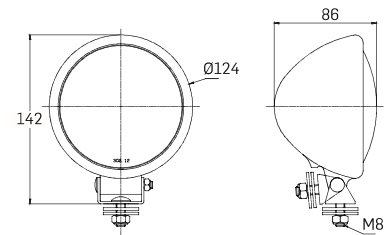

H3 PK22s

Carcaça metálica
Metallic housing
Boitier metal

H3 PK22s



Referência
Part N°
Référence

3212.0000000

3212.1000000

3212.2000000

3212.5000000

Com Comutador
With Switch
Avec interrupteur

Com Pega
With Handle
Avec Poignée

Inox
Stainless Steel
Acier Inoxydable

.

.

.

.

.

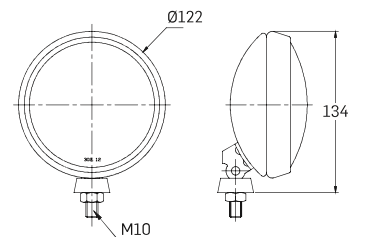

H3 PK 22s

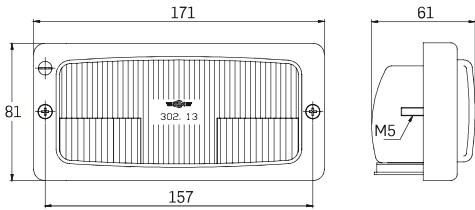

Referència
Part N°
Référence
3213.0000000



RENAULT

3213



H3 PK 22s

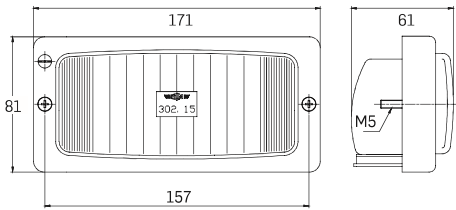

Referència
Part N°
Référence
3215.0000000



RENAULT

3215



H3 PK 22s

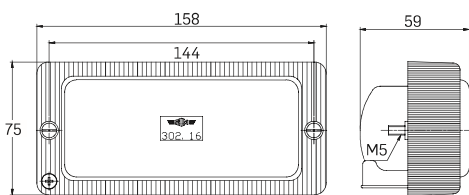

Referència
Part N°
Référence
3216.0000000



CITROËN

3216



H3 PK 22s

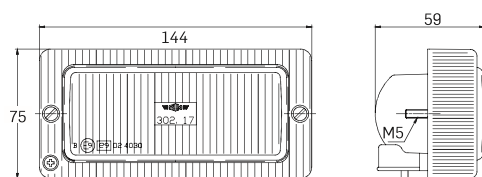

Referència
Part N°
Référence
3217.0000000



CITROËN

3217



3201

Inox
Stainless Steel
Acier Inoxydable



Referència
Part N°
Référence

3201.0000000

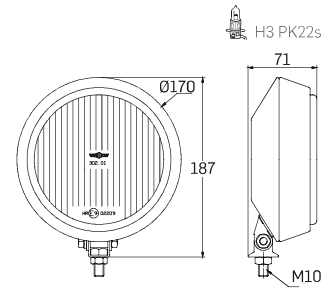

3205

Inox
Stainless Steel
Acier Inoxydable



Referència
Part N°
Référence

3205.0000000

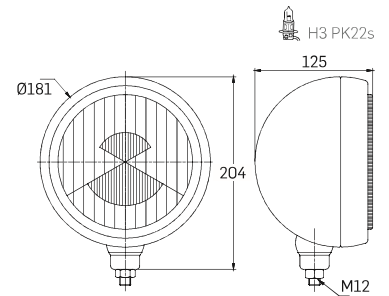

3206

Inox
Stainless Steel
Acier Inoxydable



Referència
Part N°
Référence

3206.0000000

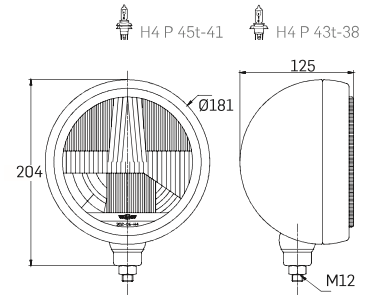

3208

Inox
Stainless Steel
Acier Inoxydable



Referència
Part N°
Référence

3208.0000000

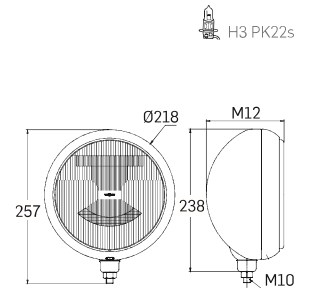

Com comutador
With switch
Avec Interrupteur

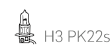

Referència
Part N°
Référence

3208.5000300

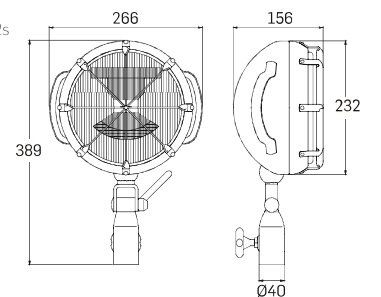

PTOTAL
2,5W - 12/24V



Iluminação de trabalho
Working lamps
Projecteurs de travail

4212

NEWPRODUCT

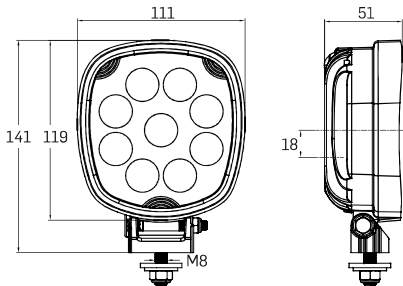

Com cabo 500mm, disponíveis outros comprimentos de cabo; consulte-nos!
With cable 500mm, available other length of cables; please check with us!
Avec cable 500mm, d'autres longueurs de câble possibles; merci nos consulter!

Referência
Part N°
Référence

Com Comutador
With Switch
Aves interrupteur

4212.0305000
4212.0305900

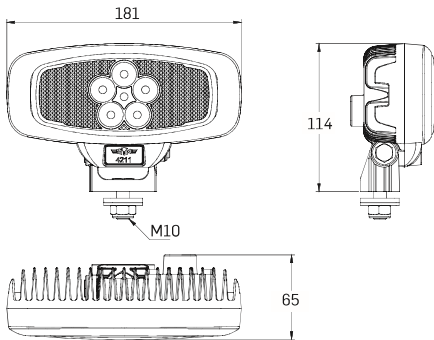

PTOTAL
15,0W - 12V
19,0W - 24V



Longo Alcance
Long Distance
Longue Portée

4211

Referência
Part N°
Référence

4211.0000000

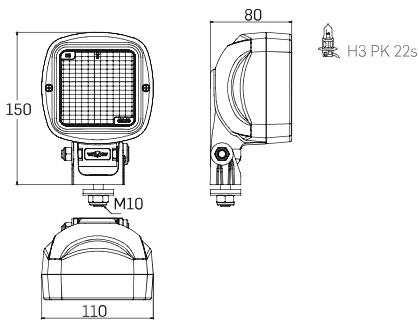

Iluminação de trabalho e luz de marcha atrás
Working lamps and reversing light
Projecteurs de travail et feu de recul

4205

Referência
Part N°
Référence

4205.0000000

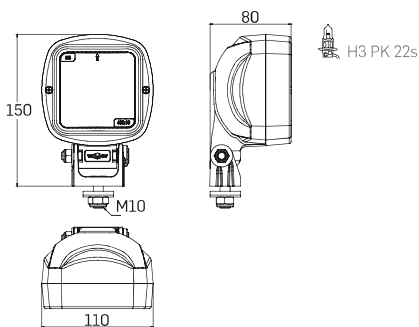

Iluminação de estrada
Traffic road lamps
Projecteurs de route

4210

Referência
Part N°
Référence

4210.0000000



4204

Carcaça metálica
Metallic housing
Boitier metal

Sem comutador
Without switch
Sans interrupteur



Referência Part N° Référence	Lâmpada Bulb Ampoule
4204.0000000	BA 20s
4204.0000400	P 45t

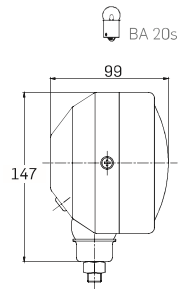
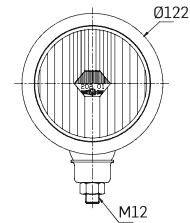

Carcaça metálica
Metallic housing
Boitier metal

Com comutador
With switch
Avec interrupteur



Referência Part N° Référence
4204.2000000

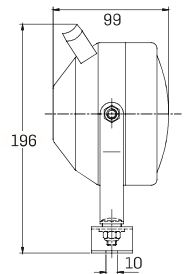
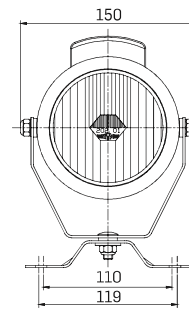

3214

Carcaça metálica
Metallic housing
Boitier metal



Referência Part N° Référence	Inox Stainless Steel Acier Inoxydable
3214.0000000	
3214.5000000	•

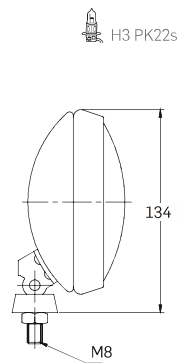
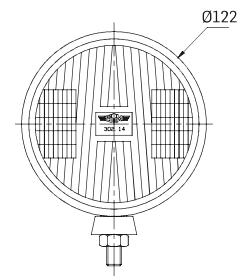

Carcaça metálica
Metallic housing
Boitier metal

Com comutador
With switch
Avec interrupteur



Referência Part N° Référence
3214.4000300

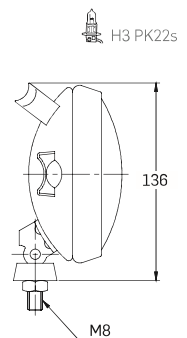
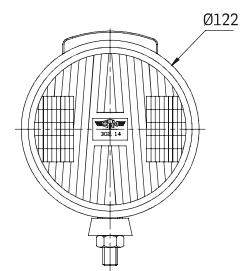

H3 PK 22s

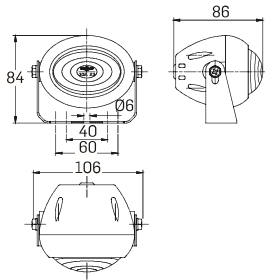

Referência
Part N°
Référence

3223.0000000



3223



H3 PK 22s

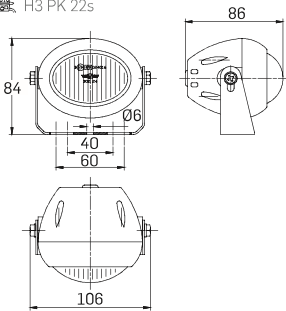

Referência
Part N°
Référence

3224.0000000



3224



H3 PK22s

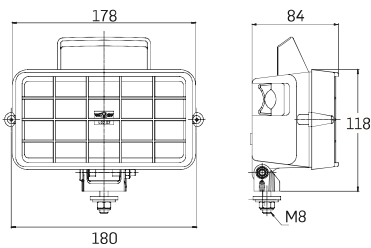

Referência
Part N°
Référence

4202.3000300



Carcaça plástica
Plastic housing
Boîtier plastique

Com comutador
With switch
Avec interrupteur

4202



H3 PK22s

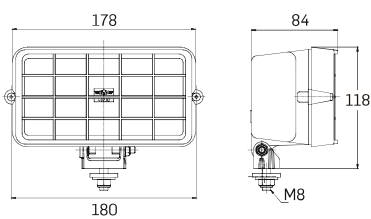

Referência
Part N°
Référence

4202.1000300

Carcaça plástica
Plastic housing
Boîtier plastique

Sem comutador
Without switch
Sans interrupteur

4201



H3 PK22s

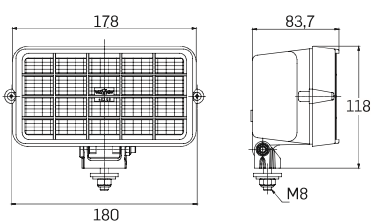

Referência
Part N°
Référence

4203.1000300

4203.3000300

Com Comutador
With Switch
Aves interrupteur

Com Pega
With Handle
Avec Poignée



Carcaça plástica
Plastic housing
Boîtier plastique

4203



4206

Iluminação de trabalho e luz de marcha atrás
Working lamps and reversing light
Projecteurs de travail et feu de recul



H3 PK22s



Carcaça plástica
Plastic housing
Boitier plastique

Sem comutador
Without switch
Sans interrupteur

Referência
Part N°
Référence

4206.000000

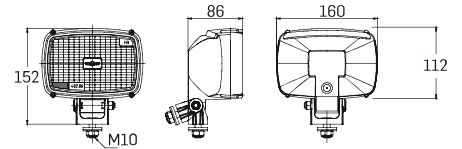

Carcaça plástica
Plastic housing
Boitier plastique

Com comutador
With switch
Avec interrupteur

Referência
Part N°
Référence

4206.300000

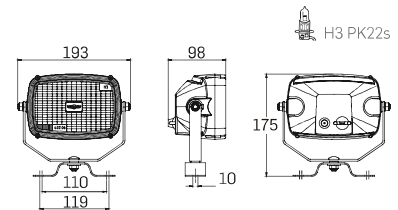

Carcaça plástica
Plastic housing
Boitier plastique

Com comutador
With switch
Avec interrupteur

Referência
Part N°
Référence

4206.100000

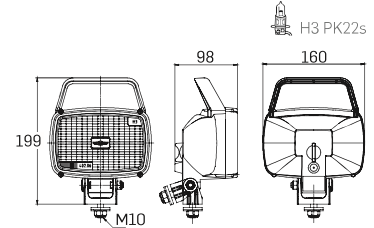

Carcaça plástica
Plastic housing
Boitier plastique

Com comutador
With switch
Avec interrupteur

Referência
Part N°
Référence

4206.400000

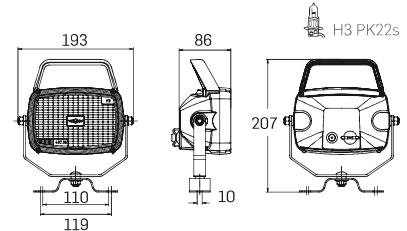

Carcaça plástica
Plastic housing
Boitier plastique

Com comutador
With switch
Avec interrupteur

Referência
Part N°
Référence

4206.200000

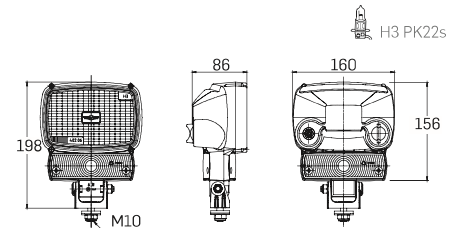

Carcaça plástica
Plastic housing
Boitier plastique

Sem comutador
Without switch
Sans interrupteur

2 x lâmpadas
2 x bulbs
2 x ampoules



H3 PK22s

Referência
Part N°
Référence

4206.500000

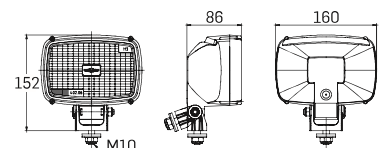

H3 PK22s

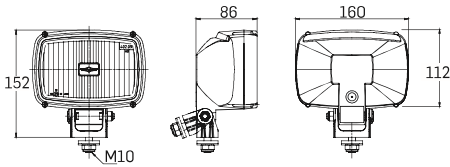

Referência
Part N°
Référence
4209.000000



Iluminação de estrada
Traffic road lamps
Projecteurs de route

Carcaça plástica
Plastic housing
Boitier plastique

Sem comutador
Without switch
Sans interrupteur

4209



H3 PK22s

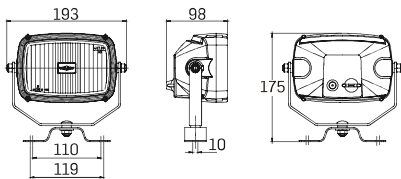

Referência
Part N°
Référence
4209.300000

Carcaça plástica
Plastic housing
Boitier plastique

Com comutador
With switch
Avec interrupteur



H3 PK22s

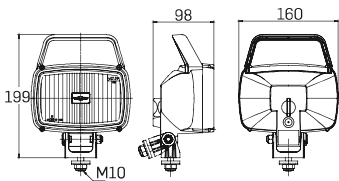

Referência
Part N°
Référence
4209.100000

Carcaça plástica
Plastic housing
Boitier plastique

Com comutador
With switch
Avec interrupteur



H3 PK22s

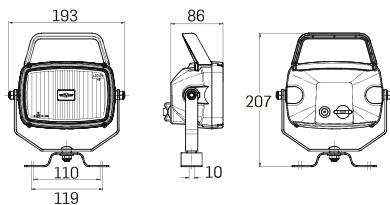

Referência
Part N°
Référence
4209.400000

Carcaça plástica
Plastic housing
Boitier plastique

Com comutador
With switch
Avec interrupteur



H3 PK22s

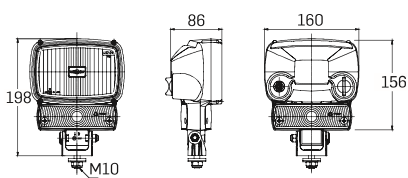

Referência
Part N°
Référence
4209.200000

Carcaça plástica
Plastic housing
Boitier plastique

Com comutador
With switch
Avec interrupteur



H3 PK22s

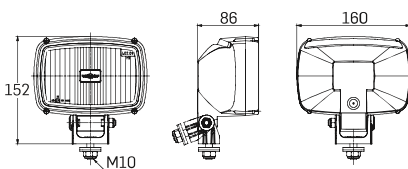

Referência
Part N°
Référence
4209.500000



Carcaça plástica
Plastic housing
Boitier plastique

Sem comutador
Without switch
Sans interrupteur

2 x lâmpadas
2 x bulbs
2 x ampoules



4208

Longo Alcance
Long Distance
Longue Portée



H3 PK22s

Carcaça plástica
Plastic housing
Boitier plastique

Sem comutador
Without switch
Sans interrupteur



Referência
Part N°
Référence

Com grelha
With grid
Avec grille

4208.1000300
4208.1100300

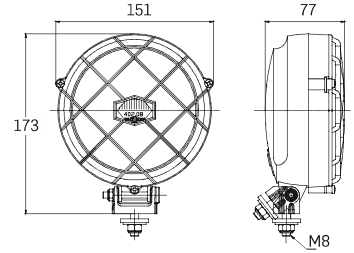

Carcaça plástica
Plastic housing
Boitier plastique

Com comutador
With switch
Avec interrupteur

H3 PK22s



Referência
Part N°
Référence

Com grelha
With grid
Avec grille

4208.2000300
4208.2100300

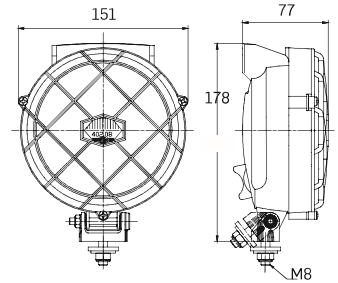

Carcaça plástica
Plastic housing
Boitier plastique

Com comutador
With switch
Avec interrupteur

H3 PK22s



Referência
Part N°
Référence

4208.3000300

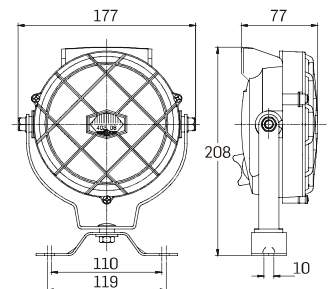

H3 PK22s

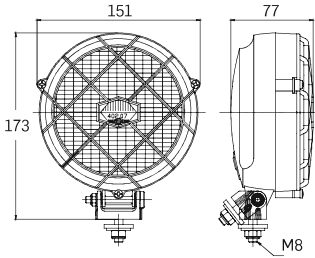

Carcaça plástica
Plastic housing
Boitier plastique

Sem comutador
Without switch
Sans interrupteur

Referência
Part N°
Référence

Com grelha
With grid
Avec grille

4207.1000300
4207.1100300



Projeção larga
Large beam
Faisceau large

4207



H3 PK22s

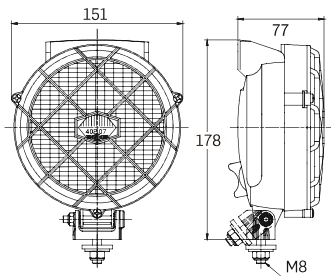

Carcaça plástica
Plastic housing
Boitier plastique

Com comutador
With switch
Avec interrupteur

Referência
Part N°
Référence

Com grelha
With grid
Avec grille

4207.2000300
4207.2100300



H3 PK22s

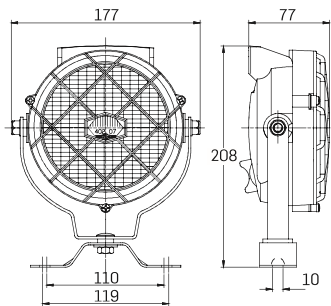

Carcaça plástica
Plastic housing
Boitier plastique

Com comutador
With switch
Avec interrupteur

Referência
Part N°
Référence

4207.3000300



H3 PK22s

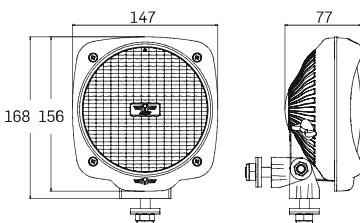

Carcaça plástica
Plastic housing
Boitier plastique

Referência
Part N°
Référence

Com Comutador
With Switch
Aves interrupteur

4207.6000300
4207.6000390



H3 PK22s

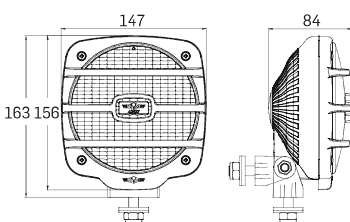

Carcaça plástica
Plastic housing
Boitier plastique

Referência
Part N°
Référence

Com Comutador
With Switch
Aves interrupteur

4207.5000300
4207.5000390



4201



Carcaça metálica
Metallic housing
Boitier metal

Sem comutador
Without switch
Sans interrupteur



Referência Part N° Référence	Lâmpada Bulb Ampoule
4201.0000000	BA 20d
4201.0000300	H3
4201.0000400	P 45t P 43t

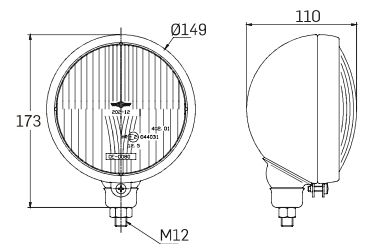

Carcaça metálica
Metallic housing
Boitier metal

Sem comutador
Without switch
Sans interrupteur



Referência Part N° Référence	Lâmpada Bulb Ampoule
4201.1000000	BA 20d
4201.1000300	H3
4201.1000400	P 45t P 43t

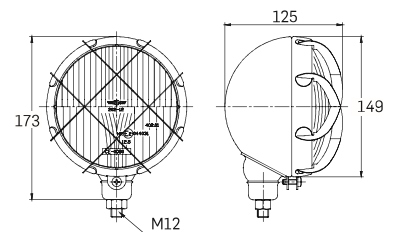

Carcaça metálica
Metallic housing
Boitier metal

Com comutador
With switch
Avec interrupteur



Referência Part N° Référence	Lâmpada Bulb Ampoule
4201.2000000	BA 20d
4201.2000300	H3
4201.2000400	P 45t P 43t

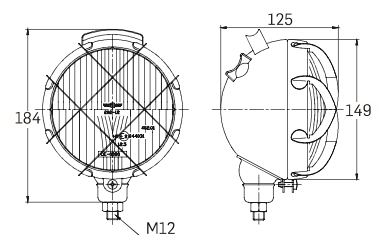

H3 PK22s



4201

Carcaça plástica
Plastic housing
Boitier plastique

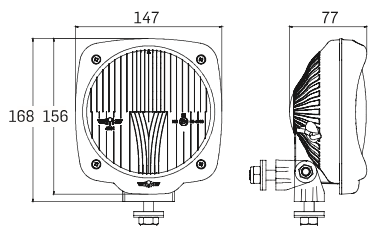

Referência Com Comutador
Part N° With Switch
Référence Aves interrupteur

4201.6000300
4201.6000390 •



H3 PK22s

Carcaça plástica
Plastic housing
Boitier plastique

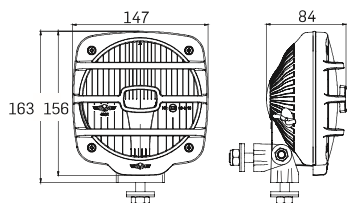

Referência Com Comutador
Part N° With Switch
Référence Aves interrupteur

4201.5000300
4201.5000390 •

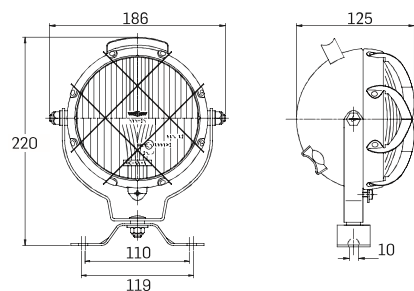

Carcaça metálica
Metallic housing
Boitier metal

Referência Lâmpada
Part N° Bulb
Référence Ampoule

4201.3000000 BA 20d
4201.3000300 H3 PK22s
4201.3000400 P 45t P 43t



LÂMPADAS AUTO-HOMOLOGADAS
HOMOLOGATED AUTOMOTIVE LAMPS
AMPOULES AUTO HOMOLOGUÉES

Assimétricas Asymmetrical Asymétrique	Base Base Base	Referência Part nr Référence	Volt Volt Volt	Watt Watt Watt
	BA 20s	12727	12	35
	BA 15s	12413	12	15
		12421	12	21
		13413	24	15
		13421	24	21
	BA 15d	12500	12	21/5
		13500	24	21/5
		12500	12	21/5
	BAY 15d	12500	12	21/5
		13500	24	21/5
	BA 15s	12821	12	5
		12814		10
		13821	24	5
		13814		10
	BA 9s	12910	12	3
		12929	12	4
		13929	24	
	T10	12256	12	3
		12961	12	5
		13256	24	
	BA 7s	12829	12	2
		13829	24	
	T5	06516	6	1,2
		12516	12	1,2
		13516	24	1,1
	11x38	12844	12	5
		13844	24	
	11x44	06864	6	5
		12866	12	
		12864		10
		13866	24	5

Halogénio Halogen Halogène	Tipo Type Type	Base Base Base	Referência Part nr Référence	Volt Volt Volt	Watt Watt Watt
	H1	P 14,5s	12258	12	55
			13258	24	70
	H3	PK 22s	12336	12	55
			13336	24	70
	H4	P 43t	12342	12	60/55
			12569	12	100/80
	H5	P 45t	12596	12	60/55
			12568	12	100/80
			13555	24	75/70

Referente Part nr Reference	Quantity Quantity Quantity	P. Br. Gr. W. PL PL PL	PL M.W. P.M. P.M. P.M.	Dimension Dimension Dimension	Volume v[m ³]
30201.9000	45	17	17	640x340x440	0.10
30020.000000	240	16	15	420x280x270	0.09
30021.000000	240	15	15	420x280x270	0.09
30022.000000	128	30	29	440x395x325	0.08
30030.000000	1500	22	21	440x395x325	0.08
30040.000000	2000	22	21	440x395x325	0.08
30042.000000	1000	11	10	440x395x325	0.08
30060.000000	1250	21	20	440x395x325	0.08
30070.000000	1000	22	21	490x400x370	0.07
30071.000000	1000	29	29	490x400x370	0.07
30081.000000	308	20	19	490x400x370	0.07
30090.000000	1500	22	21	440x395x325	0.08
30091.000000	1750	27	26	440x395x325	0.08
30092.000000	750	37	36	490x400x370	0.07
30100.000000	500	29	22	440x395x325	0.08
30101.000000	500	22	21	440x395x325	0.08
30110.000000	2000	16	17	440x395x325	0.08
30120.000000	1500	29	29	490x400x370	0.07
30121.000000	1500	31	28	490x400x370	0.07
30121.000200	300	24	29	590x270x290	0.04
30140.000000	1500	31	29	800x495x300	0.09
30150.000000	1500	30	29	800x495x300	0.09
31010.000000	92	22	20	800x495x300	0.09
31011.000000	124	21	19	490x400x370	0.07
31040.000000	200	22	20	800x495x300	0.09
3107x.000000	300	19	17	800x495x300	0.09
3107x.000000	150	11	9	440x395x325	0.08
31100.000000	1020	50	46	625x495x395	0.15
31100.000010	1000	20	19	490x400x370	0.07
311010.00200	690	46	46	625x495x395	0.15
311030.00000	398	46	46	625x495x395	0.15
311100.00000	54	25	29	625x495x395	0.15
3111x.000010	189	21	19	640x340x440	0.10
311190.00000	32	17	15	625x495x395	0.15
3112.0000x00	162	16	16	490x400x370	0.07
3112.0000x00	72	6	6	490x405x195	0.04
3113.000000	140	28	24	490x400x370	0.07
3113.0000010	300	17	15	670x340x360	0.09
3114.000000	92	24	22	490x400x370	0.07
3114.0000010	250	19	17	600x495x300	0.09
3114.10.00000	60	29	21	525x425x395	0.09
3115.00.00000	54	16	16	490x400x370	0.07
3115.00.00000	120	40	36	625x495x395	0.15
3115.00.00900	54	19	17	490x400x370	0.07
3115.10.00000	30	22	20	625x495x395	0.15
3116.00.00000	50	16	16	490x400x370	0.07
3117x.0000000	20	25	29	690x500x495	0.16
3117.00.00028	28	10	6	490x400x370	0.07
3118.00.000100	144	27	25	640x340x440	0.10
3118.10.00000	208	36	36	625x495x395	0.15
3118.10.00000	144	28	28	640x340x440	0.10
3118.10.000010	350	21	20	600x495x300	0.09
3119.00.00000	100	28	24	425x370x325	0.06
3119.00.00000	50	19	11	640x340x440	0.10
3119.00.00010	1500	19	17	600x495x300	0.09
3119.10.00000	192	19	17	650x340x395	0.10
3119.20.00000	100	28	24	425x370x325	0.06
3119.30.00000	50	19	11	640x340x440	0.10
3119.80000000	64	19	11	525x425x395	0.09

EMBALAGEM
PACKING
EMBALLAGE

Referente Part nr Reference	Quantity Quantity Quantity	P. Br. Gr. W. PL PL PL	PL M.W. P.M. P.M. P.M.	Dimension Dimension Dimension	Volume v[m ³]
3120.00000000	240	16	14	640x340x440	0.10
3120.00000010	500	19	11	640x340x440	0.10
3120.10000000	178	20	18	650x340x395	0.10
3121x.0000000	28	29	22	690x520x460	0.16
3121.00000010	72	16	14	640x340x440	0.10
3122.00000000	218	20	18	690x500x495	0.16
3129.00000000	67	29	21	525x425x395	0.09
3124.00000000	218	15	13	490x400x370	0.07
3125.00000000	24	14	12	650x340x395	0.10
3126.00000000	15	9	7	670x340x360	0.09
3127x.0000000	60	22	20	490x400x370	0.07
3128.00000000	90	17	15	490x400x370	0.07
3129.30000000	492	26	26	490x400x370	0.07
3129.40000000	492	26	26	490x400x370	0.07
3129.90000000	308	25	29	440x395x325	0.08
3129.80000000	372	22	20	800x495x300	0.09
3129.70000000	320	23	21	800x495x300	0.09
3129.60000000	320	23	21	670x340x360	0.09
3129.50000000	648	27	25	490x400x370	0.07
3130.00000000	924	34	32	625x495x395	0.15
3130.10000000	792	49	47	625x495x395	0.15
3131.00000000	150	125	105	420x280x270	0.09
3131.50000000	100	21	19	490x400x370	0.07
3132.00000000	60	11	9	490x400x370	0.07
3132.10000000	60	15	13	490x400x370	0.07
3132.20000000	48	31	29	625x495x395	0.15
3132.30000000	20	19	17	525x425x395	0.09
3132.40000000	20	19	17	425x370x325	0.06
3133.00000000	100	16	16	490x400x370	0.07
3134.00000000	90	21	19	640x340x440	0.10
3135.00000250	66	19	17	440x395x325	0.08
3136x.0000x00	42	12	10	490x405x195	0.04
3136x.0000x00	200	19	17	440x395x325	0.08
3137.50000000	112	14	12	440x395x325	0.08
3138x.0000x00	20	27	25	595x490x640	0.17
3138.0000x10	50	17	15	800x495x300	0.09
31384xxxxx	20	28	25	670x375x460	0.16
3138x.0000000	48	34	32	690x500x495	0.16
3138.0000x10	50	15	13	800x495x300	0.09
31391.0000000	48	36	34	690x500x495	0.16
31392.0000000	48	31	29	690x500x495	0.16
3140.0000200	120	20	18	440x395x325	0.08
3141.0000x00	324	25	29	490x400x370	0.07
3141.1.0000x00	252	28	24	640x340x440	0.10
3141.2.0000x00	270	28	24	525x425x395	0.09
3141.3.0000x00	240	24	22	640x340x440	0.10
3141.5xxxxx	324	28	24	490x400x370	0.07
3141.6xxxxx	252	27	25	640x340x440	0.10
3141.7xxxxx	180	21	19	425x370x325	0.06
31420.0000000	50	15	13	640x340x440	0.10
31422.0000000	50	15	13	640x340x440	0.10
31430.0000200	120	20	18	395x315x495	0.05
31440.0000000	50	17	15	525x425x395	0.09
31441.0000000	72	26	26	690x500x495	0.16
31442.0000000	32	15	13	800x495x300	0.09
31442.0000000	16	12	10	800x495x300	0.09
31450.0000000	30	19	17	525x425x395	0.09

Reference Part nr Reference	Quantity Quantity	P. Dr. Gr. N. FL. Pal	PL. N.N. P.M. Pal	Dimension Dimension Dimension	Volume vol[m ³]
3145.000010	50	13	11	800x495x900	0.09
3146.000000	680	23	21	670x340x560	0.09
3147.000000	340	26	24	670x340x560	0.09
3147.1xxxxx	320	29	21	800x495x900	0.09
3148.000000	340	39	31	525x420x360	0.09
3149.x00000	25	17	18	490x400x370	0.07
3149.x00001	25	18	18	490x400x370	0.07
3150.000010	90	15	13	490x400x370	0.07
3150.x00000	40	30	28	690x500x455	0.18
3152.000000	44	11	9	800x495x900	0.09
3153.000000	25	35	33	1050x360x370	0.22
3153.000010	40	18	14	800x495x900	0.09
3157.0xxxxx	252	18	18	640x340x440	0.10
3157.1xxxxx	252	22	20	640x340x440	0.10
3157.2xxxxx	324	25	23	490x400x370	0.07
3158.0xxxxx	252	18	18	640x340x440	0.10
3158.1xxxxx	252	22	20	640x340x440	0.10
3158.2xxxxx	324	25	23	490x400x370	0.07
3159.010900	58	27	25	490x400x370	0.07
3159.012000	55	36	36	640x340x440	0.10
3159.500000	58	24	22	490x400x370	0.07
3160.x00000	25	27	25	670x375x490	0.18
3160.000010	50	18	14	490x400x370	0.07
3161.x000300	20	30	28	555x490x440	0.17
3161.000910	40	17	15	800x495x900	0.09
3162.x00000	21	28	24	625x465x365	0.15
3162.000010	50	20	18	800x495x900	0.09
3163.000x10	36	19	17	800x495x900	0.09
3163.x000190	12	22	20	555x440x555	0.14
3164.x000x00	32	14	12	800x495x900	0.09
3164.x000010	189	24	20	640x340x440	0.10
3165.1140000	20	29	21	640x340x440	0.10
3166.000000	150	15	13	490x400x370	0.07
3167.090900	50	11	9	450x405x195	0.04
3167.130900	58	15	13	490x400x370	0.07
3168.0109xxx	100	7	5	450x405x195	0.04
3168.0209xxx	100	8	8	450x405x195	0.04
3168.8109000	45	13	11	450x405x195	0.04
3169.x00000	25	27	25	670x375x490	0.18
3169.000010	50	18	14	490x400x370	0.07
3170.000000	95	35	33	800x495x900	0.09
3171.000000	52	14	12	450x405x195	0.04
3172.000000	100	21	15	800x495x900	0.09
3173.000x00	180	27	25	800x495x900	0.09
3174.000000	100	21	20	800x495x900	0.09
3175.000000	20	32	30	550x490x440	0.17
3179.500000	58	24	22	490x400x370	0.07
3179.0109000	58	27	25	490x400x370	0.07
3180.000000	45	13	11	670x340x560	0.09
3181.000000	90	7	5	450x405x195	0.04
3182.xxxxxx	22	18	15	450x365x325	0.06
3187.000000	324	20	19	490x400x370	0.07
3187.000000	52	14	12	450x405x195	0.04
3188.000000	45	13	11	670x340x560	0.09
3190.000000	20	27	25	555x490x440	0.17
3191.000000	150	27	25	800x495x900	0.09
3192.000000	28	29	22	690x520x460	0.16
3201.000000	24	20	19	525x425x365	0.09
3202.000000	20	25	23	625x465x365	0.15
3203.000000	30	21	19	670x340x560	0.09

Reference Part nr Reference	Quantity Quantity	P. Dr. Gr. N. FL. Pal	PL. N.N. P.M. Pal	Dimension Dimension Dimension	Volume vol[m ³]
3204.000000	30	21	19	670x340x560	0.09
3205.000000	20	25	23	625x465x365	0.15
3206.000000	20	24	22	625x465x365	0.15
3208.000000	18	39	31	690x500x455	0.18
3208.500000	9	21	19	670x375x490	0.18
3210.000000	45	28	27	490x400x370	0.07
3211.000000	45	29	27	490x400x370	0.07
3212.000000	60	31	29	525x425x365	0.09
3213.000000	60	20	18	490x400x370	0.07
3214.000000	60	30	28	525x425x365	0.09
3215.000000	60	20	18	490x400x370	0.07
3216.000000	70	24	22	490x400x370	0.07
3217.x00000	70	24	22	490x400x370	0.07
3218.000000	30	12	10	450x405x195	0.04
3220.000000	75	32	30	525x425x365	0.09
3220.000000	30	12	10	450x405x195	0.04
3223.000000	60	21	19	525x425x365	0.09
3224.000000	60	21	19	525x425x365	0.09
3225.000000	17	21	19	800x495x900	0.09
3225.000000	25	23	21	640x340x440	0.10
3226.000000	17	21	19	800x495x900	0.09
3226.000000	25	23	21	640x340x440	0.10
3227.x000x00	22	27	25	690x500x455	0.17
3227.000000	45	10	8	800x495x900	0.09
3228.x000x00	22	27	25	690x500x455	0.17
3228.000000	44	30	28	625x465x365	0.16
3229.100000	20	24	22	470x365x315	0.05
4201.000000	44	36	34	690x500x455	0.18
4201.100000	44	39	37	690x500x455	0.17
4201.200000	44	36	36	690x500x455	0.18
4201.300000	24	27	25	670x375x490	0.18
4201.800000	42	28	24	640x340x470	0.10
4201.800000	42	28	24	640x340x470	0.10
4202.100000	60	36	36	625x465x365	0.15
4202.300000	30	22	20	640x340x440	0.10
4203.100000	60	36	36	625x465x365	0.15
4203.300000	30	22	20	640x340x440	0.10
4204.000000	34	21	19	670x340x560	0.09
4204.200000	24	22	20	690x340x395	0.10
4205.000000	30	18	14	440x365x325	0.06
4206.000000	36	24	22	800x495x900	0.09
4206.100000	25	18	18	800x495x900	0.09
4206.200000	25	29	21	800x495x900	0.09
4206.300000	24	22	20	800x495x900	0.09
4206.400000	24	29	21	800x495x900	0.09
4207.100000	66	40	36	690x500x455	0.18
4207.200000	44	30	28	625x465x365	0.15
4207.300000	36	36	36	670x375x490	0.18
4207.300000	20	20	18	670x340x560	0.09
4207.500000	42	28	24	640x340x470	0.10
4207.800000	42	28	24	640x340x470	0.10
4208.100000	66	40	36	690x500x455	0.18
4208.200000	44	30	28	625x465x365	0.15
4208.300000	36	35	33	670x375x490	0.18
4208.300000	20	19	17	670x340x560	0.09
4209.000000	36	24	22	800x495x900	0.09
4209.100000	25	18	18	800x495x900	0.09
4209.200000	25	29	21	800x495x900	0.09
4210.000000	30	18	14	440x365x325	0.06
4211.000000	18	17	15	450x405x195	0.04