

rinder

catálogo general · general catalogue · gesamtkatalog · catalogue général

+50

años diseñando y fabricando dispositivos de iluminación para la industria de automoción.

designing and manufacturing lighting devices for the automotive industry.

projekt und Herstellung von Leuchten für die Automobilindustrie.

des années d'expérience dans la conception et la fabrication de systèmes d'éclairage pour.



Autobús Bus Bus Autobus



Trailer Trailer Lastzug Semi-remorque



Camión Truck LKW Camion



Carretilla Wheelbarrow Handwagen Engin de manutention



Agrícola Agricultural Landwirtschaftliche Nutzung Agricole



Caravana Caravan Caravan Caravane



Autocaravana Autocaravan Wohnmobil Camping-car



Remolque Trailer/tow Lastwagen Remorque



Obras Públicas Public works Bauarbeiten Travaux publics



Coche Car Auto Voiture



Derecha Right Rechte Droit



Izquierda Left Linke Gauche

| | |
|--|-----|
| Faros Head Lamps Scheinwerfer Phares | 13 |
| Faros de Trabajo Work Lamps Arbeitscheinwerfer Projecteur de Travail | 23 |
| Pilotos Delanteros Front Lamps Vorne Rücklicht Feux Avant | 29 |
| Pilotos Traseros Rear Lamps Rücklicht Feux Arrière | 35 |
| Luces de Posición Position Lamps Lichtraum Feux de Position | 67 |
| Luces de Posición Lateral Side Marker Lamps Seitenmarkierungsleuchten Feux Latéraux de Position | 79 |
| Intermitentes Laterales Side Indicators Seiteblinkleuchte Clignotants Latéraux | 85 |
| Luces de Freno Brake Lights Zusatzbremsleuchte Feux de Stop | 87 |
| Luces de Matrícula Number Plate Lights Kennzeichenbeleuchtung Eclairer de Plaques | 91 |
| Pilotos Marcha Atrás Reversing Lights Rückfahrleuchte Feux de Recul | 95 |
| Pilotos Antiniebla Fog Lamps Nebelschlußleuchte Feux de Brouillard | 97 |
| Luces Interiores Interior Lights Innenleuchten Eclairage Interieur | 99 |
| Catadiópticos + Placas Reflectors + Plates Warntafeln und Rückstrahler Catadioptré + Plaques | 103 |
| Bocinas + Retroalarmas Horns + Back-up Alarms Hupe + Rückfahrwarner Avertisseur et Alarme de Recul | 111 |
| Desconectores Switch Isolators Batteriehauptschalter Coupe Batterie | 125 |
| Reductores de Tensión + Cargadores de Batería tension Reducer + Battery Shipper Spannunggetriebe + Batterieladegerät Reducteur de Tension + Chargeur de Batterie | 127 |
| Conectores + Conexiones Eléctricas Connectors + Electrical Conections Buchse + Elektrische Verbindungen Connecteur + Connexions Électriques | 131 |
| Destellantes + Rotativos Xenon Beacons + Rotating Beacons Politz Kennleuchten + Rundumkennleuchten Feu à Eclats + Gyrophares | 139 |
| Cámaras Marcha Atrás Reverse Camera Kit Rückfahrkamera Camera de Recul | 151 |
| Accesorios Accesories Zubehör Accessoires | 155 |
| Lámparas Lamps Glühlampen Lampes | 158 |

| Foto | Ref. | Pág. | Foto | Ref. | Pág. | Foto | Ref. | Pág. | Foto | Ref. | Pág. |
|------|-------------------------|------|------|----------------------------------|------|------|----------------|------|------|--|------|
| | 4.00 | 140 | | 34.12 34.24 | 115 | | 73.12 73.24 | 116 | | 94.00 | 145 |
| | 5.00 | 112 | | 35.00 36.00 | 143 | | 79.03 | 128 | | 95.00 | 145 |
| | 6.00 | 140 | | 39.00 39.00 39.00 | 115 | | 79.06 | 128 | | 96.00 | 145 |
| | 6.50 | 140 | | 40.00 41.00 | 141 | | 79.12 | 128 | | 97.00 | 145 |
| | 7.00 | 112 | | 42.00 | 140 | | 79.18 | 129 | | 98.00 | 145 |
| | 10.00 11.00 12.00 | 144 | | 43.00 | 112 | | 79.24 | 129 | | 110.00 | 126 |
| | 13.00 | 144 | | 44.00 | 140 | | 79.50 | 129 | | 111.00 | 126 |
| | 14.00 | 144 | | 45.00 46.00 | 142 | | 83.00 | 145 | | 112.00 | 126 |
| | 15.00 | 144 | | 48.12 48.24 | 142 | | 84.00 | 145 | | 113.00 | 126 |
| | 16.00 | 144 | | 49.12 49.24 | 143 | | 85.12 85.24 | 141 | | 124.00 | 126 |
| | 24.00 | 116 | | 50.00 50.50 | 140 | | 86.12 86.24 | 141 | | 145.00 | 49 |
| | 25.00 26.00 | 143 | | 51.00 52.00 53.00 54.00 | 142 | | 87.12 87.24 | 141 | | 160.00 161.00 162.00 163.00 164.00 165.00 | 49 |
| | 27.00 28.00 | 143 | | 55.00 56.00 | 142 | | 88.12 88.24 | 141 | | 166.00 167.00 | 49 |
| | 30.01 | 157 | | 66.12 66.24 | 115 | | 90.00 | 145 | | 168.00 168.50 | 83 |
| | 30.02 | 157 | | 67.12 67.24 | 116 | | 91.00 | 145 | | 169.00 169.50 | 83 |
| | 31.00 | 114 | | 68.00 | 116 | | 93.00 | 145 | | 170.00 170.50 | 80 |

| Foto | Ref. | Pág. | Foto | Ref. | Pág. | Foto | Ref. | Pág. | Foto | Ref. | Pág. |
|------|--------------------------------------|------|------|----------------------------|------|------|--------|------|------|--|------|
| | 170R.00 170I.00 | 73 | | 418.00 | 16 | | 479.01 | 15 | | 502.40 502.50 | 18 |
| | 171.00 171.50 | 80 | | 418.01 | 16 | | 479.50 | 15 | | 503.00 | 18 |
| | 171R.00 171I.00 171V.00 | 73 | | 446.00 447.00 | 25 | | 479.51 | 15 | | 504.00 | 25 |
| | 172.00 172.10 172.50 172.60 | 80 | | 450.00 451.00 | 26 | | 488.00 | 14 | | 505.00 | 25 |
| | 172R.00 172I.00 | 73 | | 453.00 | 24 | | 488.01 | 14 | | 506.00 | 25 |
| | 173.00 173.10 173.50 173.60 | 80 | | 453.26 | 24 | | 491.00 | 15 | | 507.00 | 28 |
| | 173R.00 173I.00 | 73 | | 454.00 454.12 454.24 | 26 | | 491.01 | 15 | | 510.00 | 18 |
| | 174.00 174.50 175.00 175.50 | 80 | | 455.00 455.12 455.24 | 27 | | 491.50 | 15 | | 511.12 511.24 512.12 512.24 | 60 |
| | 178.00 | 82 | | 456.00 456.12 456.24 | 27 | | 491.51 | 15 | | 513.12 513.24 514.12 514.24 516.00 | 60 |
| | 178.50 178.51 | 81 | | 457.00 | 26 | | 492.00 | 14 | | 517.12 517.24 | 60 |
| | 179.00 | 82 | | 458.00 458.12 458.24 | 26 | | 492.01 | 14 | | 518.12 518.24 | 60 |
| | 179.50 179.51 179.60 179.61 | 82 | | 459.00 | 26 | | 495.00 | 15 | | 519.12 519.24 | 60 |
| | 196.00 196.50 197.00 197.50 | 55 | | 460.00 | 20 | | 495.01 | 15 | | 520.12 520.24 | 60 |
| | 198.00 198.50 199.00 199.50 | 55 | | 461.00 463.00 | 24 | | 495.50 | 15 | | 521.00 | 60 |
| | 414.00 | 17 | | 465.00 | 20 | | 495.51 | 15 | | 522.12 522.24 | 61 |
| | 414.01 | 17 | | 479.00 | 15 | | 502.00 | 18 | | 523.12 523.24 | 61 |

| Foto | Ref. | Pág. | Foto | Ref. | Pág. | Foto | Ref. | Pág. | Foto | Ref. | Pág. |
|------|--------------------------------------|------|------|--------------------------------------|------|------|------------------|------|------|------------------|------|
| | 524.12 524.24 | 61 | | 554.20 | 57 | | 569.00 | 102 | | 613.12 613.24 | 150 |
| | 525.12 525.24 | 61 | | 554.30 | 57 | | 570.00 | 102 | | 614.12 614.24 | 150 |
| | 526.12 526.24 527.12 527.24 | 61 | | 554.40 556.00 | 57 | | 578.00 | 98 | | 615.00 | 70 |
| | 528.12 528.24 | 62 | | 556.10 | 57 | | 580.00 | 98 | | 616.00 | 70 |
| | 529.12 529.24 | 62 | | 556.30 | 57 | | 581.00 | 98 | | 617.00 | 70 |
| | 530.12 530.24 | 62 | | 557.00 | 57 | | 582.00 | 98 | | 620.00 | 68 |
| | 531.12 531.24 | 62 | | 557.10 | 57 | | 587.00 | 96 | | 620.01 | 69 |
| | 532.12 532.24 | 62 | | 558.00 | 57 | | 588.00 | 96 | | 621.00 | 68 |
| | 532.52 532.64 | 62 | | 558.10 | 57 | | 589.00 | 96 | | 621.01 | 69 |
| | 533.12 533.24 | 62 | | 559.10 | 57 | | 590.00 | 96 | | 622.00 | 68 |
| | 540.00 541.00 542.00 | 20 | | 559.30 | 57 | | 592.00 593.00 | 31 | | 622.01 | 69 |
| | 552.00 | 57 | | 559.40 | 57 | | 594.00 595.00 | 31 | | 623.00 624.00 | 32 |
| | 552.10 | 57 | | 560.00 561.00 562.00 | 21 | | 596.00 597.00 | 32 | | 629.00 | 33 |
| | 553.00 | 57 | | 564.00 | 20 | | 598.00 599.00 | 30 | | 633.00 634.00 | 33 |
| | 554.00 | 57 | | 567.12 567.24 567.62 567.74 | 100 | | 602.00 603.00 | 30 | | 635.00 636.00 | 34 |
| | 554.10 | 57 | | 568.12 568.24 568.62 568.74 | 101 | | 604.00 605.00 | 32 | | 637.00 | 32 |

| Foto | Ref. | Pág. | Foto | Ref. | Pág. | Foto | Ref. | Pág. | Foto | Ref. | Pág. |
|------|----------------------------|------|------|--|------|------|--------------------------------------|------|------|--------------------------------------|------|
| | 638.00 638.50 | 71 | | 662.00 663.00 | 19 | | 683.12 683.24 683.62 683.74 | 147 | | 703R.00 | 106 |
| | 639.00 639.50 | 71 | | 664.00 664A.12 664A.24 | 148 | | 684.12 684.24 684.62 684.74 | 147 | | 704A.00 | 105 |
| | 640.00 640.50 | 71 | | 665.00 665A.12 665A.24 | 148 | | 685.12 685.24 685.62 685.74 | 147 | | 704I.00 | 105 |
| | 641.00 642.00 | 59 | | 666.00 666A.12 666A.24 | 148 | | 697.00 | 33 | | 704R.00 | 105 |
| | 643.00 | 59 | | 667.00 667A.12 667A.24 | 149 | | 698.00 699.00 | 31 | | 705A.00 | 106 |
| | 644.00 645.00 646.00 | 59 | | 668.00 668A.12 668A.24 | 149 | | 700A.00 | 106 | | 705I.00 | 106 |
| | 647.00 | 59 | | 669.00 669A.12 669A.24 | 149 | | 700I.00 | 106 | | 705R.00 | 106 |
| | 648.00 | 59 | | 671.00 671.50 672.00 672.50 | 58 | | 700R.00 | 106 | | 710R.00 711R.00 | 107 |
| | 649.00 650.00 | 30 | | 673.00 673.50 | 58 | | 701A.00 | 106 | | 712A.00 712R.00 712I.00 | 107 |
| | 651.00 652.00 | 30 | | 674.00 674.50 675.00 675.50 676.00 676.50 | 58 | | 701I.00 | 106 | | 713.12 713.24 713.32 713.44 | 77 |
| | 654.00 | 19 | | 677.00 677.50 | 58 | | 701R.00 | 106 | | 714.12 714.24 714.32 714.44 | 77 |
| | 656.00 | 31 | | 678.00 678.50 | 58 | | 702A.00 | 106 | | 715.12 715.24 | 81 |
| | 657.00 658.00 | 19 | | 679.00 | 33 | | 702I.00 | 106 | | 715.52 715.54 | 81 |
| | 659.00 | 150 | | 680.12 680.24 680.62 680.74 | 146 | | 702R.00 | 106 | | 716I.12 716I.24 | 89 |
| | 660.00 | 19 | | 681.12 681.24 681.62 681.74 | 146 | | 703A.00 | 106 | | 716R.12 716R.24 | 89 |
| | 661.00 | 150 | | 682.12 682.24 682.62 682.74 | 146 | | 703I.00 | 106 | | 717I.07 717I.08 | 90 |

| Foto | Ref. | Pág. | Foto | Ref. | Pág. | Foto | Ref. | Pág. | Foto | Ref. | Pág. |
|------|--|------|------|--|------|------|--------------------|------|------|--------------------------------------|------|
| | 717L.12 717L.24 | 89 | | 727.00 728.00 | 47 | | 743R.12 743R.24 | 88 | | 752A.00 | 105 |
| | 717R.07 717R.08 | 90 | | 729.00 | 22 | | 744I.07 744I.08 | 90 | | 752I.00 | 105 |
| | 717R.12 717R.24 | 89 | | 730.00 | 22 | | 744I.12 744I.24 | 88 | | 752R.00 | 105 |
| | 718L.12 718L.24 | 89 | | 731.00 | 22 | | 744R.12 744R.24 | 88 | | 755A.00 | 105 |
| | 718R.12 718R.24 | 89 | | 732.00 | 22 | | 745A.00 | 105 | | 755I.00 | 105 |
| | 719A.00 719A.20 | 84 | | 734.00 734.01 734.05 734.20 734.21 734.25 | 36 | | 745I.00 | 105 | | 755R.00 | 105 |
| | 719A.30 719A.50 719A.70 719A.90 | 84 | | 734.40 734.41 734.45 735.00 735.05 735.20 | 36 | | 745R.00 | 105 | | 756.00 756.50 757.00 | 40 |
| | 719I.00 719I.50 | 78 | | 735.25 735.40 735.45 | 36 | | 746A.00 | 105 | | 758.00 758.10 759.00 759.10 | 40 |
| | 719R.00 719R.50 | 78 | | 736.00 736.01 736.05 736.20 736.21 736.25 | 37 | | 746I.00 | 105 | | 760.00 760.05 761.00 761.05 | 38 |
| | 720A.00 720A.20 | 84 | | 736.40 736.41 736.45 737.00 737.20 737.40 | 37 | | 746R.00 | 105 | | 762.00 763.00 | 38 |
| | 720A.30 720A.50 720A.70 720A.90 | 84 | | 738.00 739.00 | 42 | | 747A.00 | 104 | | 764R.00 764R.27 | 104 |
| | 720I.00 720I.50 | 78 | | 740I.12 740I.24 | 88 | | 747I.00 | 104 | | 765A.00 | 104 |
| | 720R.00 720R.50 | 78 | | 740R.12 740R.24 | 88 | | 747R.00 | 104 | | 765I.00 | 104 |
| | 721.00 722.00 | 46 | | 741.00 742.00 | 51 | | 751A.00 | 105 | | 765R.00 | 104 |
| | 723.00 724.00 | 48 | | 743I.12 743I.24 | 88 | | 751I.00 | 105 | | 766A.00 | 104 |
| | 725.00 726.00 | 47 | | 743R.07 743R.08 | 90 | | 751R.00 | 105 | | 766I.00 | 104 |

| Foto | Ref. | Pág. | Foto | Ref. | Pág. | Foto | Ref. | Pág. | Foto | Ref. | Pág. |
|------|--------------------------------------|------|------|--|------|------|----------------------------|------|------|--------------------------------------|------|
| | 766R.00 | 104 | | 790A.00 | 104 | | 815.00 | 63 | | 847.00 | 75 |
| | 767.12 767.24 | 94 | | 790I.00 | 104 | | 818.00 | 64 | | 848.00 849.00 | 75 |
| | 768A.00 | 106 | | 790R.00 | 104 | | 819.00 820.00 | 64 | | 851.00 | 64 |
| | 768I.00 | 106 | | 791.00 791.50 792.00 792.50 | 45 | | 822.00 | 156 | | 852.00 | 64 |
| | 768R.00 | 106 | | 793.00 793.10 793.20 793.30 793.40 | 50 | | 827.00 | 53 | | 853.00 | 75 |
| | 769.00 | 93 | | 793.50 | 50 | | 828.00 | 34 | | 854.00 | 65 |
| | 769.50 | 93 | | 794.00 794.10 794.20 794.30 794.40 | 50 | | 829.00 | 53 | | 855.00 | 65 |
| | 769R.00 | 93 | | 794.50 | 50 | | 830.00 831.00 | 53 | | 858.00 | 63 |
| | 769R.50 | 93 | | 797.00 798.00 | 42 | | 832.00 833.00 | 34 | | 859.00 860.00 861.00 | 63 |
| | 770.00 771.00 772.00 773.00 | 46 | | 799.00 800.00 801.00 802.00 | 72 | | 834.00 835.00 | 53 | | 862.00 863.00 | 63 |
| | 778.00 779.00 | 41 | | 803.00 804.00 | 72 | | 840.00 841.00 | 66 | | 864.00 | 63 |
| | 780.00 | 157 | | 805.02 805.03 805.04 805.05 | 76 | | 842.00 | 39 | | 868.00 | 48 |
| | 781.00 782.00 | 51 | | 808.00 | 63 | | 843.00 | 66 | | 869A.00 869I.00 869R.00 | 74 |
| | 783.00 784.00 | 41 | | 809.00 810.00 811.00 | 63 | | 844.00 | 39 | | 870.00 871.00 872.00 | 74 |
| | 785.00 785.10 786.00 786.10 | 39 | | 812.00 | 63 | | 845.00 | 66 | | 874.00 | 54 |
| | 787.00 787.10 788.00 788.10 | 39 | | 813.00 | 63 | | 846.00 846.01 846.02 | 75 | | 876.00 876.10 877.00 877.10 | 39 |

| Foto | Ref. | Pág. | Foto | Ref. | Pág. | Foto | Ref. | Pág. | Foto | Ref. | Pág. |
|------|----------------------------|------|------|--------------------------------------|------|------|--------------------------------------|------|------|----------------------------|------|
| | 879.00 | 65 | | 912.00 | 28 | | 941.00 942.00 | 59 | | 958.10 | 56 |
| | 881.00 881R.00 | 76 | | 913.00 | 28 | | 943.00 | 59 | | 959.10 | 56 |
| | 886.00 | 72 | | 915.00 916.00 917.00 918.00 | 46 | | 944.00 945.00 946.00 | 59 | | 959.30 959.40 | 56 |
| | 887.00 888.00 | 86 | | 921.00 921R.00 | 76 | | 947.00 | 59 | | 961.00 962.00 | 156 |
| | 889.00 | 74 | | 922.00 | 45 | | 948.00 | 59 | | 963.00 | 92 |
| | 890.00 | 54 | | 922.09 | 45 | | 950.00 951.00 | 156 | | 964.00 | 92 |
| | 891.00 | 54 | | 923.00 | 45 | | 952.00 | 56 | | 965.00 | 92 |
| | 892.00 | 54 | | 923.09 | 45 | | 952.10 | 56 | | 969.00 | 92 |
| | 893.00 894.00 895.00 | 74 | | 924.00 | 42 | | 953.00 | 56 | | 970.00 | 94 |
| | 896.00 897.00 898.00 | 72 | | 924.10 | 44 | | 954.00 | 56 | | 971.00 | 94 |
| | 899.00 | 74 | | 925.00 | 42 | | 954.10 | 56 | | 974.00 975.00 | 47 |
| | 903.00 | 21 | | 925.10 | 44 | | 954.20 954.30 954.40 956.00 | 56 | | 979.00 979.50 980.00 | 43 |
| | 907.00 | 21 | | 926A.00 | 86 | | 956.10 | 56 | | 981.00 981.10 | 43 |
| | 909.00 | 27 | | 926I.00 | 86 | | 956.30 957.00 | 56 | | 981.20 | 44 |
| | 910.00 | 27 | | 929.00 930.00 | 43 | | 957.10 | 56 | | 982.00 982.10 | 43 |
| | 911.00 | 28 | | 935.00 936.00 937.00 938.00 | 46 | | 958.00 | 56 | | 982.20 | 44 |

| Foto | Ref. | Pág. | Foto | Ref. | Pág. | Foto | Ref. | Pág. | Foto | Ref. | Pág. |
|------|----------------------------|------|------|--------------------|------|------|--------------------|------|------|--------------------|------|
| | 983.00 983.50 984.00 | 44 | | 3018.00 | 135 | | 3059.00 3059.60 | 137 | | 3099.00 | 132 |
| | 985.00 986.00 | 40 | | 3019.00 | 135 | | 3070.00 | 135 | | 3144.00 | 138 |
| | 987.00 988.00 | 41 | | 3020.00 | 136 | | 3071.00 | 135 | | 3145.00 | 138 |
| | 989.12 989.24 | 86 | | 3022.00 | 133 | | 3072.00 | 135 | | 5700.00 5700.50 | 108 |
| | 994.00 995.00 | 21 | | 3023.00 | 134 | | 3073.00 | 135 | | 5701.00 | 108 |
| | 996.00 997.00 | 22 | | 3024.00 | 133 | | 3077.00 | 132 | | 5701.50 | 108 |
| | 1010.12 1010.24 | 130 | | 3025.00 | 134 | | 3081.00 | 132 | | 5702.00 | 109 |
| | 1011.12 1011.24 | 130 | | 3026.00 | 133 | | 3088.00 | 132 | | 5703.00 | 109 |
| | 2704.11 | 144 | | 3027.00 | 134 | | 3091.00 | 136 | | 5706.00 5707.00 | 109 |
| | 3007.11 | 144 | | 3028.00 | 133 | | 3092.00 | 136 | | 5708.00 | 110 |
| | 3008.11 | 144 | | 3029.00 | 134 | | 3093.00 | 134 | | 5709.00 | 110 |
| | 3011.11 | 144 | | 3032.00 | 138 | | 3094.00 | 134 | | 5710.00 | 110 |
| | 3014.00 | 133 | | 3036.00 3036.60 | 137 | | 3095.00 | 134 | | 5711.00 | 110 |
| | 3015.00 | 133 | | 3038.00 3038.60 | 137 | | 3096.00 | 134 | | 5712.00 | 110 |
| | 3016.00 | 133 | | 3039.00 3039.60 | 137 | | 3097.00 | 132 | | 5714.00 | 110 |
| | 3017.00 | 133 | | 3058.00 | 136 | | 3098.00 | 132 | | 5715.00 | 108 |

| Foto | Ref. | Pág. | Foto | Ref. | Pág. | Foto | Ref. | Pág. | Foto | Ref. | Pág. |
|------|--|------|------|---|------|------|---|------|------|------|------|
| | 5716.00 | 108 | | 5814.00 5815.00 | 124 | | 5956.00 | 152 | | | |
| | 5800A.12 5800G.12 | 118 | | 5816.24 | 117 | | 5957.00 | 153 | | | |
| | 5801A.12 5801G.12 | 118 | | 5817.00 | 124 | | 5958.00 | 153 | | | |
| | 5802A.12 5802A.24 5802A.36 5802A.48 5802A.80 | 117 | | 5818.00 | 124 | | 5959.00 | 153 | | | |
| | 5802G.12 5802G.24 5802G.36 5802G.48 5802G.80 | 117 | | 5819.12 5819.24 | 124 | | 5960.00 | 153 | | | |
| | 5804.12 5804.24 | 119 | | 5900.00 5901.00 5902.00 5903.00 5904.00 | 113 | | 5961.00 | 154 | | | |
| | 5805.12 | 119 | | 5905.00 5906.00 | 114 | | 5962.05 5962.10 5962.15 5962.20 5962.30 | 154 | | | |
| | 5806.12 | 120 | | 5907.00 | 114 | | 82600.00 82601.00 | 51 | | | |
| | 5807.12 | 120 | | 5908.00 5909.00 5910.00 5911.00 | 113 | | 82602.00 82603.00 | 51 | | | |
| | 5808.24 | 121 | | 5912.00 | 114 | | 82604.00 82605.00 | 52 | | | |
| | 5809.24 | 121 | | 5913.00 5914.00 | 113 | | 82606.00 82607.00 | 52 | | | |
| | 5810A.24 5810G.24 | 123 | | 5915.00 5916.00 | 112 | | 82608.00 82609.00 | 52 | | | |
| | 5811.00 | 122 | | 5952.00 | 152 | | 82610.00 82611.00 | 52 | | | |
| | 5811.01 | 122 | | 5953.00 | 152 | | | | | | |
| | 5812.00 | 122 | | 5954.00 | 152 | | | | | | |
| | 5813A.24 5813G.24 | 123 | | 5955.00 | 152 | | | | | | |

Faros
Head Lamps
Scheinwerfer
Phares

+ 50 years
illuminating your way



Faros Head Lamps

Scheinwerfer Phares

■ Aplicación / ■ Application / ■ Anwendung / ■ Application



- FARO CRUCE
- LOW BEAM
- ABBLENDLICHT
- FEU DE CROISEMENT

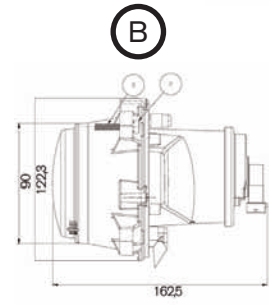
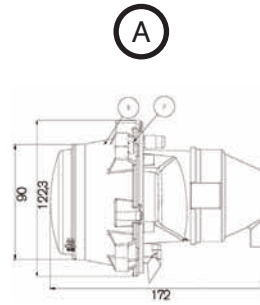
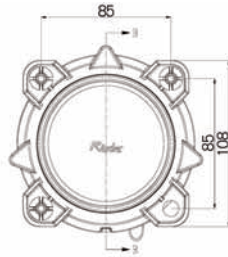

H7

H11

SAE DOT
E

| REF. | | | | 12/24V H7 | 12/24V H11 |
|--------|---|---|---|-----------|------------|
| 488.00 | ● | ● | A | ● | |
| 492.00 | ● | ● | B | | ● |

■ Aplicación / ■ Application / ■ Anwendung / ■ Application



- FARO CRUCE
- LOW BEAM
- ABBLENDLICHT
- FEU DE CROISEMENT

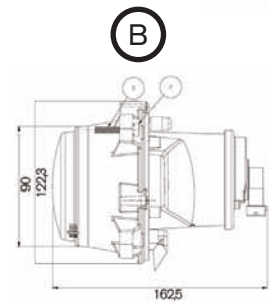
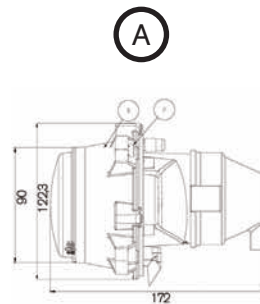
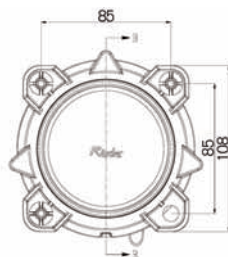

H7

H11

SAE DOT
E

| REF. | | | | 12/24V H7 | 12/24V H11 |
|--------|---|---|---|-----------|------------|
| 488.01 | ● | ● | A | ● | |
| 492.01 | ● | ● | B | | ● |

Faros | Scheinwerfer Head Lamps | Phares

■ Aplicación / ■ Application / ■ Anwendung / ■ Application



- FARO RUTA
- MAIN BEAM
- FAHRSCHEINWERFER
- FEU DE ROUTE

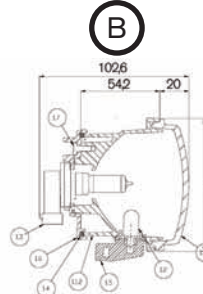
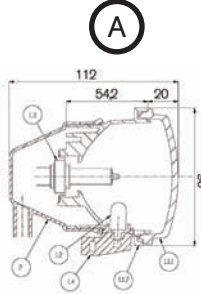
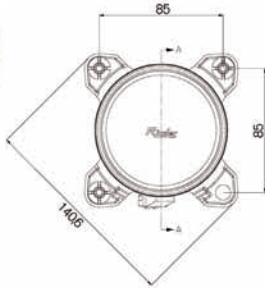

H7



H9



H11



| REF. | | | | | | 12/24V H7 | 12V H9 | 12/24V H11 | W5W |
|--------|---|---|--|--|--|-----------|--------|------------|-----|
| 491.00 | ● | ● | | | | ● | | | ● |
| 491.50 | ● | ● | | | | ● | | | ● |
| 495.00 | ● | ● | | | | | ● | | ● |
| 495.50 | ● | ● | | | | | ● | | ● |
| 479.00 | ● | ● | | | | | | ● | ● |
| 479.50 | ● | ● | | | | | | ● | ● |

SAE DOT
E

■ Aplicación / ■ Application / ■ Anwendung / ■ Application



- FARO RUTA
- MAIN BEAM
- FAHRSCHEINWERFER
- FEU DE ROUTE

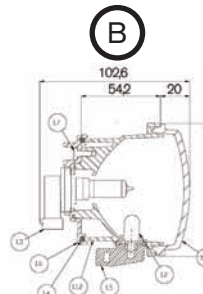
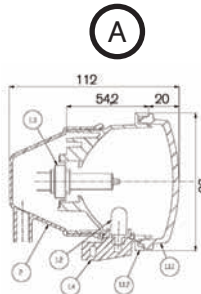
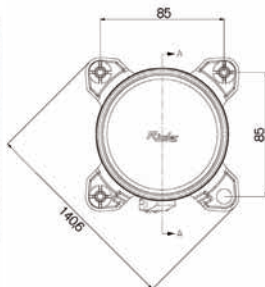

H7



H9



H11



| REF. | | | | | | 12/24V H7 | 12V H9 | 12/24V H11 | W5W |
|--------|---|---|--|--|--|-----------|--------|------------|-----|
| 491.01 | ● | ● | | | | ● | | | ● |
| 491.51 | ● | ● | | | | ● | | | ● |
| 495.01 | ● | ● | | | | | ● | | ● |
| 495.51 | ● | ● | | | | | ● | | ● |
| 479.01 | ● | ● | | | | | | ● | ● |
| 479.51 | ● | ● | | | | | | ● | ● |

SAE DOT
E

Faros Head Lamps

Scheinwerfer Phares

■ Aplicación / ■ Application / ■ Anwendung / ■ Application



- FARO ANTINEBLA
- FOG LAMPS
- NEBELSCHEINWERFER
- FEU ANTIBROUILLARD

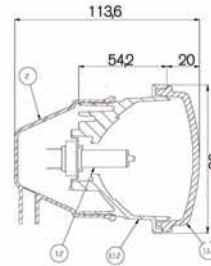
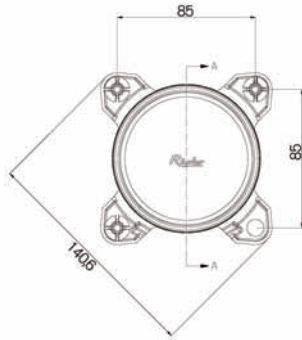

(E)

| | | | | |
|--------|---|---|---|-----------|
| REF. | | | | 12/24V H7 |
| 418.00 | ● | ● | ● | |

■ Aplicación / ■ Application / ■ Anwendung / ■ Application



- FARO ANTINEBLA
- FOG LAMPS
- NEBELSCHEINWERFER
- FEU ANTIBROUILLARD

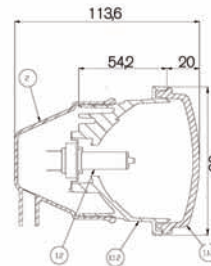
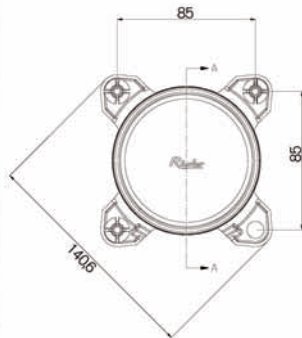
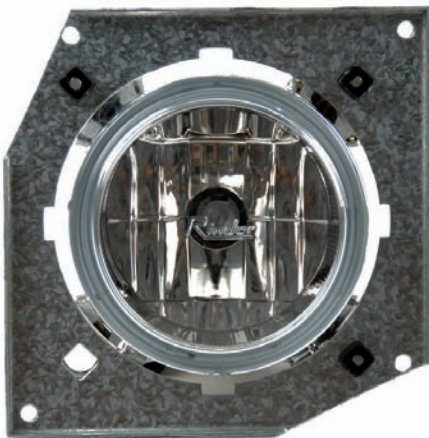

(E)

| | | | | |
|--------|---|---|---|-----------|
| REF. | | | | 12/24V H7 |
| 418.01 | ● | ● | ● | |

Faros | Scheinwerfer Head Lamps | Phares

■ Aplicación / ■ Application / ■ Anwendung / ■ Application



- FARO LUZ DIURNA + LUZ DE POSICIÓN
- DAY RUNNING LIGHT + POSITION LAMP
- TAGESLICHT + POSITIONSLICHT
- FEU POUR ECLAIRAGE DE JOUR + FEUX DE POSITION

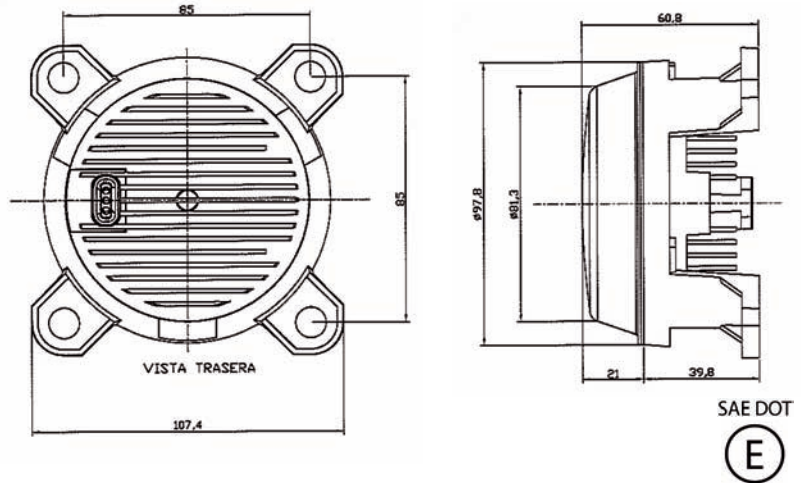
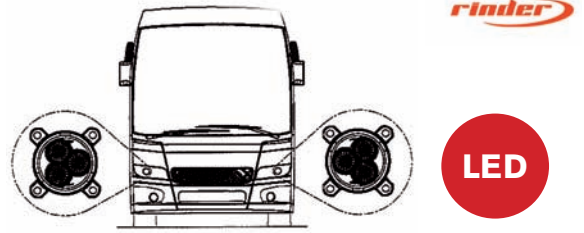

| | | | |
|--------|---|---|---------|
| REF. | | | LED |
| 414.00 | ● | ● | 12V/24V |

■ Aplicación / ■ Application / ■ Anwendung / ■ Application



- FARO LUZ DIURNA + LUZ DE POSICIÓN
- DAY RUNNING LIGHT + POSITION LAMP
- TAGESLICHT + POSITIONSLICHT
- FEU POUR ECLAIRAGE DE JOUR + FEUX DE POSITION

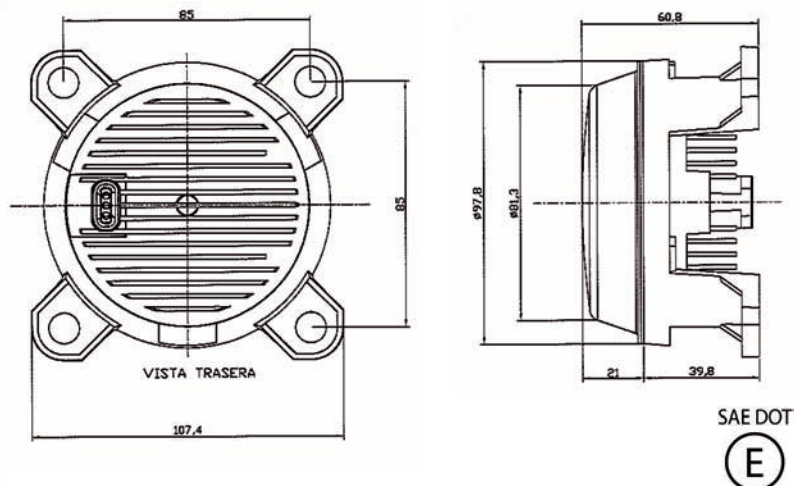
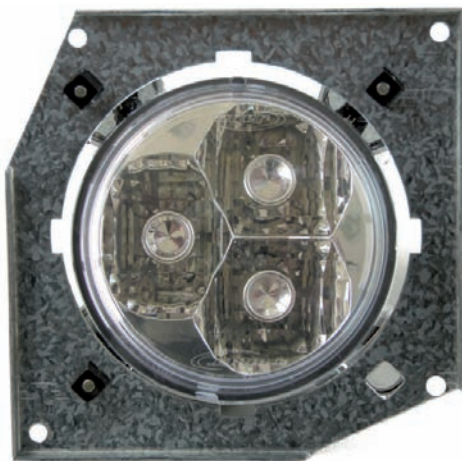
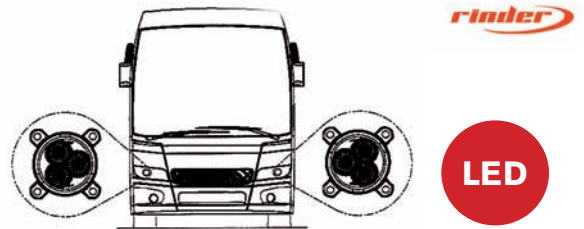

| | | | |
|--------|---|---|---------|
| REF. | | | LED |
| 414.01 | ● | ● | 12V/24V |

Faros | Scheinwerfer Head Lamps | Phares

■ Aplicación / ■ Application / ■ Anwendung / ■ Application

IRIZAR INTERCENTURY

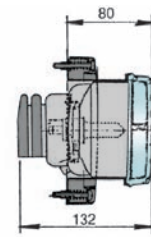
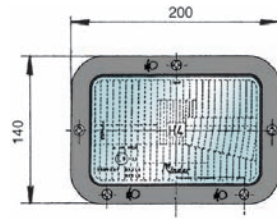

(E)

| REF. | | | | 24V 75/70W H4 | | 24V 4W |
|--------|---|---|--|---------------|--|--------|
| 502.40 | ● | ● | | ● | | ● |
| 502.50 | ● | ● | | ● | | |

■ Aplicación / ■ Application / ■ Anwendung / ■ Application

KUBOTA K1

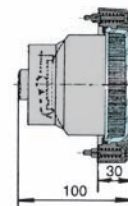
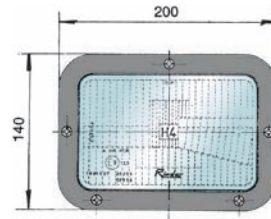

(E)

| REF. | | | | 12V 60/55W H4 24V 75/70W H4 |
|--------|---|---|--|--------------------------------|
| 502.00 | ● | ● | | ● |

■ Aplicación / ■ Application / ■ Anwendung / ■ Application

EBRO FORD
JOHN DEERE MF
CASE

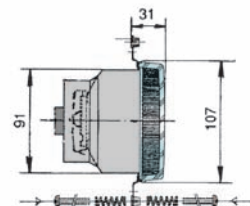
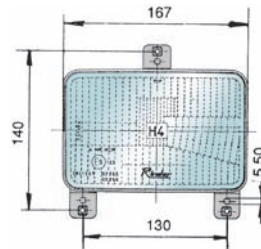

(E)

| REF. | | | | 12V 60/55W H4 24V 75/70W H4 |
|--------|---|---|--|--------------------------------|
| 503.00 | ● | ● | | ● |

■ Aplicación / ■ Application / ■ Anwendung / ■ Application

IVECO

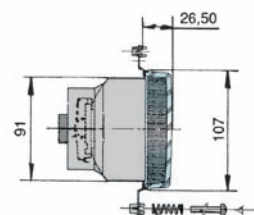
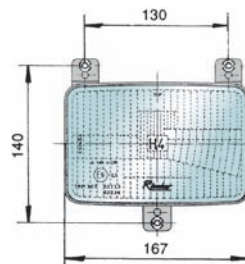

(E)

| REF. | | | | 12V 60/55W H4 24V 75/70W H4 | | 12/24V 4W |
|--------|---|---|--|--------------------------------|--|-----------|
| 510.00 | ● | ● | | ● | | ● |

Faros | Scheinwerfer Head Lamps | Phares

■ Aplicación / ■ Application / ■ Anwendung / ■ Application

KUBOTA

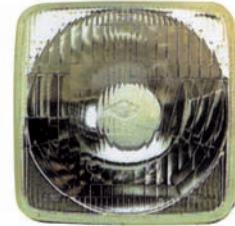
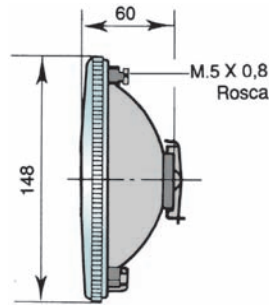

(E)

| REF. | | | | 12V 45/40W |
|--------|-------------------------------------|-------------------------------------|-------------------------------------|-------------------------------------|
| 654.00 | <input checked="" type="checkbox"/> | <input checked="" type="checkbox"/> | <input checked="" type="checkbox"/> | <input checked="" type="checkbox"/> |

■ Aplicación / ■ Application / ■ Anwendung / ■ Application

EBRO

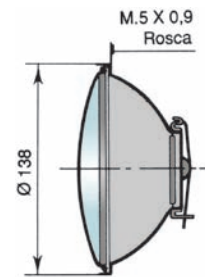

(E)

| REF. | | | | 12V 45/40W |
|--------|-------------------------------------|-------------------------------------|-------------------------------------|-------------------------------------|
| 657.00 | <input checked="" type="checkbox"/> | <input type="checkbox"/> | <input checked="" type="checkbox"/> | <input checked="" type="checkbox"/> |
| 658.00 | <input type="checkbox"/> | <input checked="" type="checkbox"/> | <input checked="" type="checkbox"/> | <input checked="" type="checkbox"/> |

■ Aplicación / ■ Application / ■ Anwendung / ■ Application

AGRIA HISPANIA

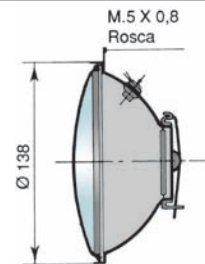

(E)

| REF. | | | | 12V 45/40W | | 12V 4W |
|--------|-------------------------------------|-------------------------------------|-------------------------------------|-------------------------------------|-------------------------------------|-------------------------------------|
| 662.00 | <input checked="" type="checkbox"/> | <input type="checkbox"/> | <input checked="" type="checkbox"/> | <input checked="" type="checkbox"/> | <input checked="" type="checkbox"/> | <input checked="" type="checkbox"/> |
| 663.00 | <input type="checkbox"/> | <input checked="" type="checkbox"/> | <input checked="" type="checkbox"/> | <input checked="" type="checkbox"/> | <input checked="" type="checkbox"/> | <input checked="" type="checkbox"/> |

■ Aplicación / ■ Application / ■ Anwendung / ■ Application

JOHN DEERE

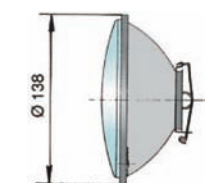

(E)

| REF. | | | | 12V 45/40W |
|--------|-------------------------------------|-------------------------------------|-------------------------------------|-------------------------------------|
| 660.00 | <input checked="" type="checkbox"/> | <input checked="" type="checkbox"/> | <input checked="" type="checkbox"/> | <input checked="" type="checkbox"/> |

Faros | Scheinwerfer Head Lamps | Phares

■ Aplicación / ■ Application / ■ Anwendung / ■ Application



■ Vertical / ■ Vertical / ■ Vertikal / ■ Vertical
○ Derecha / ○ Right / ○ Rechts / ○ Right
○ Izquierda / ○ Left / ○ Links / ○ Left

| REF. | ■ Posición ■ Position ■ Position ■ Position | 12V 45/40W 24V 55/50W | 12/24V 4W | |
|--------|--|--------------------------|-----------|---------|
| 540.00 | | ● | ● | 9651.11 |
| 541.00 | | ● | ● | 9652.11 |
| 542.00 | | ● | ● | 9653.11 |

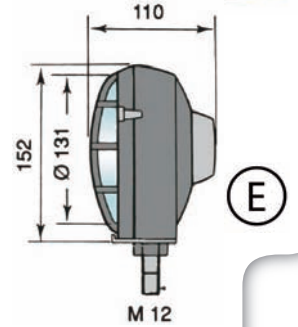

■ Aplicación / ■ Application / ■ Anwendung / ■ Application



| REF. | ■ Posición ■ Position ■ Standlicht ■ Position | 12V 45/40W 24V 55/50W | 12/24V 4W | |
|--------|--|--------------------------|-----------|---------|
| 564.00 | | ● | ● | 9608.11 |

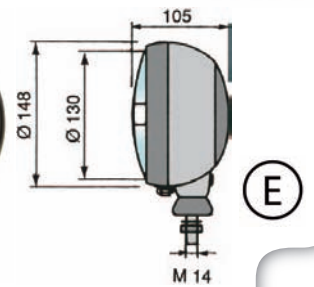

■ Aplicación / ■ Application / ■ Anwendung / ■ Application



| REF. | Ba 20d | Ba 9s | |
|--------|--------|-------|---------|
| 460.00 | ● | ● | 9602.11 |

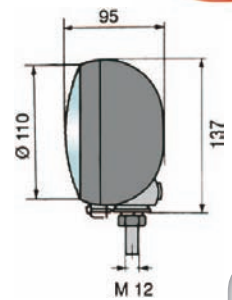

■ Aplicación / ■ Application / ■ Anwendung / ■ Application



| REF. | Ba 20d | Ba 9s | |
|--------|--------|-------|---------|
| 465.00 | ● | ● | 9602.11 |

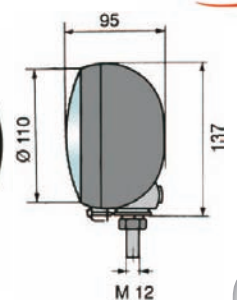

Faros | Scheinwerfer Head Lamps | Phares

■ Aplicación / ■ Application / ■ Anwendung / ■ Application



● Vertical / ● Vertical / ● Vertical / ● Vertical
 ● Derecha / ● Derecha / ● Derecha / ● Derecha
 ● Izquierda / ● Izquierda / ● Izquierda / ● Izquierda

| REF. | Posición Position Position Position | 12V 45/40W 24V 55/50W | 12/24V 4W | |
|--------|--|--------------------------|-----------|---------|
| 560.00 | ● | ● | ● | 9608.11 |
| 561.00 | ○ | ● | ● | 9608.11 |
| 562.00 | ○ | ● | ● | 9608.11 |

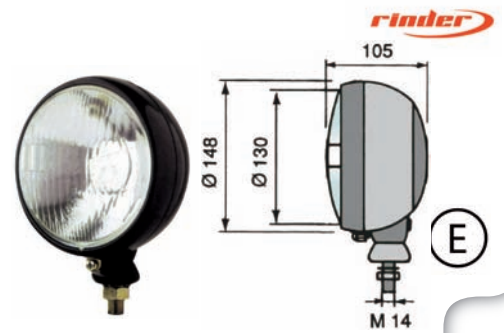

■ Aplicación / ■ Application / ■ Anwendung / ■ Application



■ FARO ANTINEBLA
 ■ FOG LAMP
 ■ NEBELSCHEINWERFER
 ■ FEU ANTIBROUILLARD

| REF. | 12V 55W H3 24V 70W H3 | |
|--------|--------------------------|---------|
| 907.00 | ● | 9641.11 |

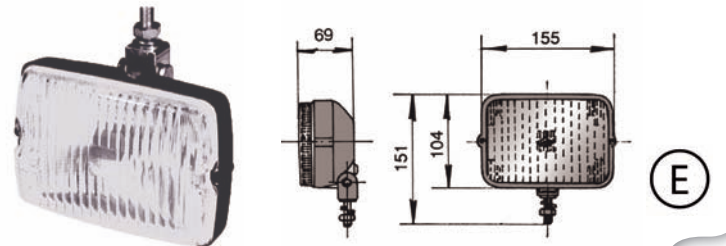

■ Aplicación / ■ Application / ■ Anwendung / ■ Application



■ FARO ANTINEBLA
 ■ FOG LAMP
 ■ NEBELSCHEINWERFER
 ■ FEU ANTIBROUILLARD

| REF. | 12V 55W H3 24V 70W H3 | |
|--------|--------------------------|---------|
| 903.00 | ● | 9641.11 |

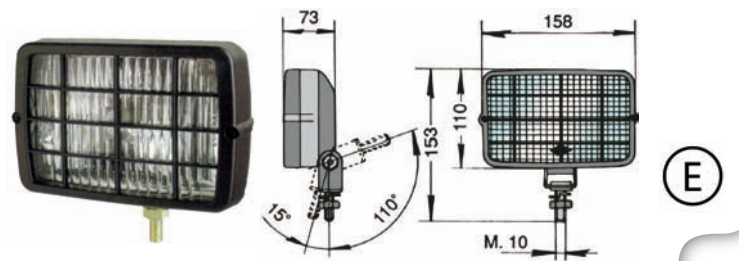

■ Aplicación / ■ Application / ■ Anwendung / ■ Application



■ Cerquillo
 ■ Rim
 ■ Glashalterahmen
 ■ Cerclage

| REF. | 24V 70W H3 | |
|--------|------------|---------|
| 994.00 | ● | 9666.11 |
| 995.00 | ● | 9666.11 |

■ FARO ANTINEBLA
 ■ FOG LAMP
 ■ NEBELSCHEINWERFER
 ■ FEU ANTIBROUILLARD

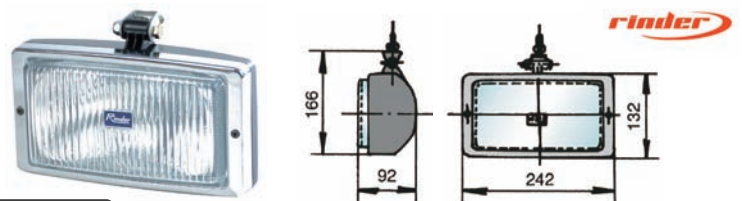

Faros | Scheinwerfer Head Lamps | Phares

■ Aplicación / ■ Application / ■ Anwendung / ■ Application



- FARO LARGO ALCANCE
- SPOT LIGHT
- FERNSCHEINWERFER
- FEU À LONGUE PORTÉE

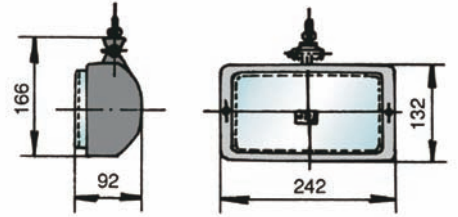

| REF. | <ul style="list-style-type: none"> ■ Cerquillo ■ Rim ■ Glashalterahmen ■ Cerclage | 24V 70W H3 | |
|--------|---|------------|---------|
| 996.00 | ● | ● | 9667.11 |
| 997.00 | ● | ● | 9667.11 |



■ Aplicación / ■ Application / ■ Anwendung / ■ Application



- FARO LARGO ALCANCE
- SPOT LIGHT
- FERNSCHEINWERFER
- FEU À LONGUE PORTÉE

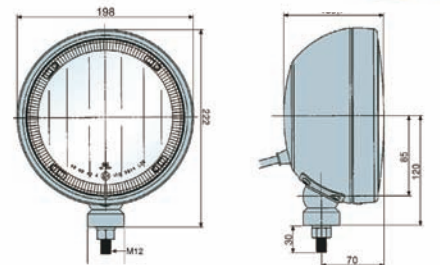

| REF. | <ul style="list-style-type: none"> ■ Incoloro ■ Clear ■ Klar ■ Incolore | | <ul style="list-style-type: none"> ■ Azul ■ Blue ■ Blau ■ Bleu | | 24V 70W H3 |
|--------|---|---|--|---|------------|
| | | | | | |
| 729.00 | ● | | | ● | |
| 730.00 | | ● | | ● | |



■ Aro Posición LEDs / ■ Circular LEDs Front Position / ■ Rund Frontsitz LEDs / ■ Feu de Position Circular à Leds

■ Aplicación / ■ Application / ■ Anwendung / ■ Application



- FARO LARGO ALCANCE
- SPOT LIGHT
- FERNSCHEINWERFER
- FEU À LONGUE PORTÉE

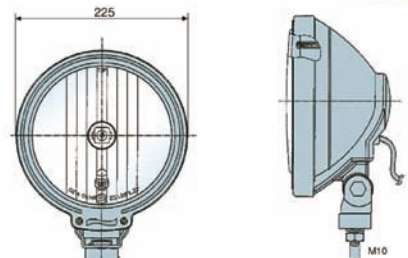

| REF. | <ul style="list-style-type: none"> ■ Incoloro ■ Clear ■ Klar ■ Incolore | | <ul style="list-style-type: none"> ■ Azul ■ Blue ■ Blau ■ Bleu | | 24V 70W H3 | 24V 5W |
|--------|---|---|--|---|------------|--------|
| | | | | | | |
| 731.00 | ● | | | ● | ● | |
| 732.00 | | ● | | ● | ● | |



Faros de Trabajo
Work Lamps
Arbeitscheinwerfer
Projecteur de Travail

The Day

at night



Faros de Trabajo | Arbeitscheinwerfer Work Lamps | Projecteur de Travail

■ Aplicación / ■ Application / ■ Anwendung / ■ Application

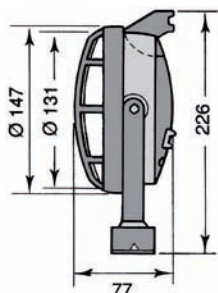

1

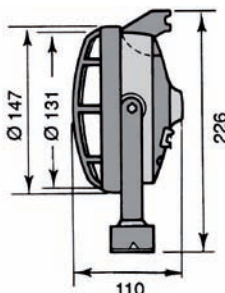

2

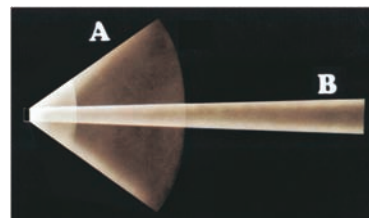

| REF. | 12V 55W H3 24V 70W H3 | 12V 45/40W 24V 55/50W | | | |
|--------|--------------------------|--------------------------|---|---|---------|
| 453.00 | ● | | A | 1 | 9600.11 |
| 463.00 | ● | | B | 1 | 9626.11 |
| 461.00 | | ● | A | 2 | 9654.11 |

■ Con interruptor / ■ With switch / ■ Mit Schalter / ■ Avec interrupteur

■ Aplicación / ■ Application / ■ Anwendung / ■ Application

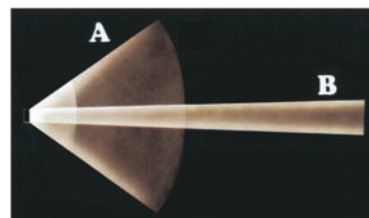
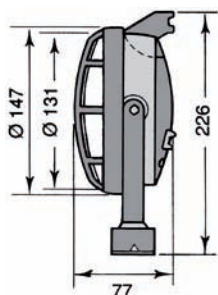

| REF. | 12V 55W H3 24V 70W H3 | | |
|--------|--------------------------|---|---------|
| 453.26 | ● | A | 9600.11 |

■ Con interruptor / ■ With switch / ■ Mit Schalter / ■ Avec interrupteur

Faros de Trabajo | **Arbeitscheinwerfer** Work Lamps | **Projecteur de Travail**

■ Aplicación / ■ Application / ■ Anwendung / ■ Application

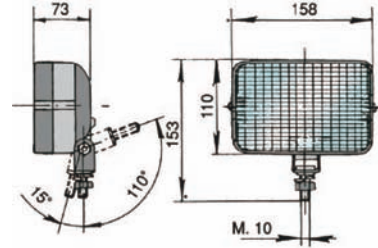

REF.  12V 55W H3
504.00

■ Aplicación / ■ Application / ■ Anwendung / ■ Application

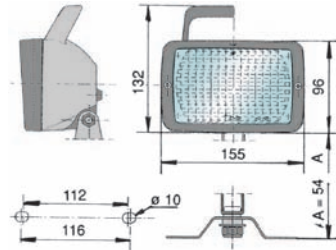

REF.  12V 55W H3
505.00

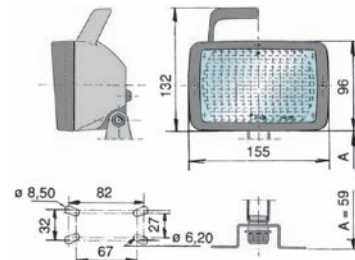

■ Aplicación / ■ Application / ■ Anwendung / ■ Application

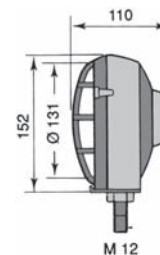

REF.  12V 55W H3
506.00

■ Aplicación / ■ Application / ■ Anwendung / ■ Application



| | | | |
|--------|--|--|---|
| REF. |  12V 55W H3 24V 70W H3 |  12V 45/40W 24V 55/50W |  |
| 446.00 | <input type="checkbox"/> | <input type="checkbox"/> | 9654.11 |
| 447.00 | <input checked="" type="checkbox"/> | <input type="checkbox"/> | 9600.11 |

Faros de Trabajo | Arbeitscheinwerfer Work Lamps | Projecteur de Travail

■ Aplicación / ■ Application / ■ Anwendung / ■ Application



| REF. | 12V 55W H3 24V 70W H3 | 12V 45/40W 24V 55/50W | |
|--------|--------------------------|--------------------------|---------|
| 459.00 | | ● | 9604.11 |
| 457.00 | ● | | 9635.11 |

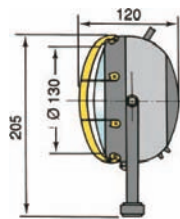

■ Aplicación / ■ Application / ■ Anwendung / ■ Application



| REF. | 12V 55W H3 24V 70W H3 | 12V 45/40W 24V 55/50W | |
|--------|--------------------------|--------------------------|---------|
| 450.00 | | ● | 9638.11 |
| 451.00 | ● | | 9639.11 |

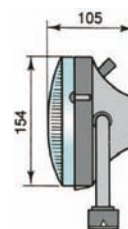

■ Aplicación / ■ Application / ■ Anwendung / ■ Application



| REF. | 12V 55W H3 24V 70W H3 | |
|----------|--------------------------|---------|
| 458.00 | ● | 9142.11 |
| * 458.12 | 12V 55W H3 | 9142.11 |
| * 458.24 | 24V 70W H3 | 9142.11 |

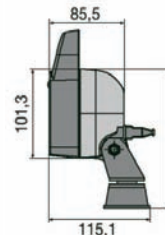

* Lámpara Colocada / ■ Placed Lamp / ■ Plaziert Lamp / ■ Avec Ampoule

■ Aplicación / ■ Application / ■ Anwendung / ■ Application



| REF. | 12V 55W H3 24V 70W H3 | |
|----------|--------------------------|---------|
| 454.00 | ● | 9142.11 |
| * 454.12 | 12V 55W H3 | 9142.11 |
| * 454.24 | 24V 70W H3 | 9142.11 |

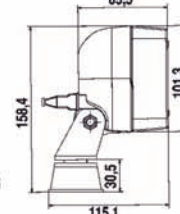
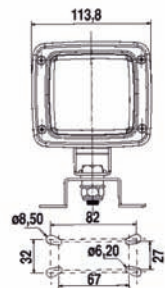

* Lámpara Colocada / ■ Placed Lamp / ■ Plaziert Lamp / ■ Avec Ampoule

Faros de Trabajo | Arbeitscheinwerfer Work Lamps | Projecteur de Travail

■ Aplicación / ■ Application / ■ Anwendung / ■ Application



| REF. | 12V 55W H3 24V 70W H3 | |
|----------|--------------------------|---------|
| 455.00 | ● | 9142.11 |
| * 455.12 | 12V 55W H3 | 9142.11 |
| * 455.24 | 24V 70W H3 | 9142.11 |

* ■ Lámpara Colocada / ■ Placed Lamp / ■ Plaziert Lamp / ■ Avec Ampoule

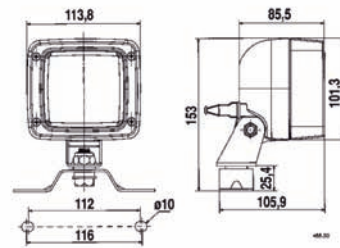

■ Aplicación / ■ Application / ■ Anwendung / ■ Application



| REF. | 12V 55W H3 24V 70W H3 | |
|----------|--------------------------|---------|
| 456.00 | ● | 9142.11 |
| * 456.12 | 12V 55W H3 | 9142.11 |
| * 456.24 | 24V 70W H3 | 9142.11 |

* ■ Lámpara Colocada / ■ Placed Lamp / ■ Plaziert Lamp / ■ Avec Ampoule

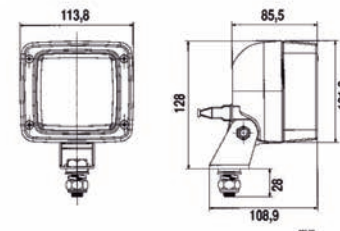

■ Aplicación / ■ Application / ■ Anwendung / ■ Application



| REF. | 12V 55W H3 24V 70W H3 | |
|--------|--------------------------|---------|
| 909.00 | ● | 9663.11 |

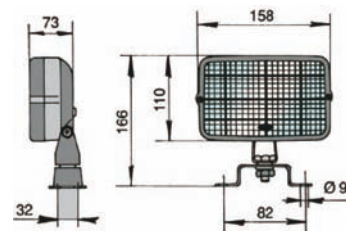

■ Aplicación / ■ Application / ■ Anwendung / ■ Application



| REF. | 12V 55W H3 24V 70W H3 | |
|--------|--------------------------|---------|
| 910.00 | ● | 9663.11 |

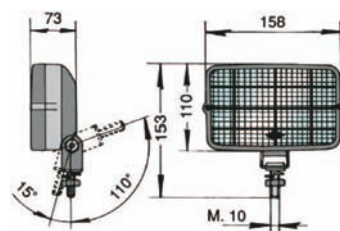

Faros de Trabajo | **Arbeitscheinwerfer** Work Lamps | **Projecteur de Travail**

■ Aplicación / ■ Application / ■ Anwendung / ■ Application

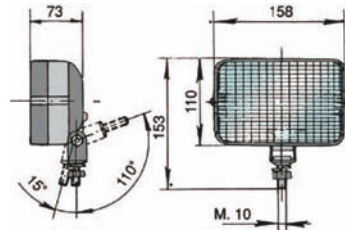

| | | |
|--------|--------------------------|---------|
| REF. | 12V 55W H3 24V 70W H3 | |
| 913.00 | ● | 9663.11 |

■ Aplicación / ■ Application / ■ Anwendung / ■ Application

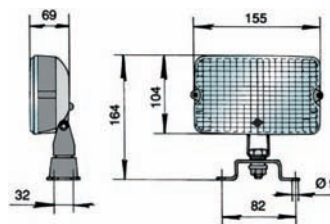

| | | |
|--------|--------------------------|---------|
| REF. | 12V 55W H3 24V 70W H3 | |
| 911.00 | ● | 9663.11 |

■ Aplicación / ■ Application / ■ Anwendung / ■ Application

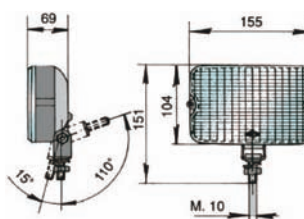

| | | |
|--------|--------------------------|---------|
| REF. | 12V 55W H3 24V 70W H3 | |
| 912.00 | ● | 9663.11 |

■ Aplicación / ■ Application / ■ Anwendung / ■ Application

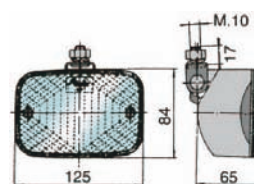

| | |
|--------|--------------------|
| REF. | 12V 21W 48V 25W |
| 507.00 | ● |

Pilotos Delanteros
Front Lamps
Vorne Rücklicht
Feux Avant

This is
your way

Pilotos Delanteros Front Lamps

Vorne Rücklicht Feux Avant

■ Aplicación / ■ Application / ■ Anwendung / ■ Application



FIAT DUCATO 94 - 01



REF.



602.00

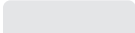

603.00

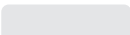

■ Aplicación / ■ Application / ■ Anwendung / ■ Application



IVECO DAILY 2000 99 - 04



REF.



649.00

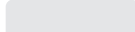

650.00

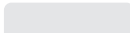

■ Aplicación / ■ Application / ■ Anwendung / ■ Application



IVECO DAILY 2004 04 - 06



REF.



651.00

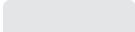

652.00

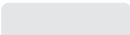

■ Aplicación / ■ Application / ■ Anwendung / ■ Application



IVECO EUROCARGO → 91



REF.



598.00

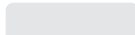

599.00

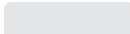

Pilotos Delanteros Front Lamps

Vorne Rücklicht Feux Avant

■ Aplicación / ■ Application / ■ Anwendung / ■ Application

IVECO EURO CARGO 91 - 02



(E)

| REF. | | |
|--------|-------------------------------------|-------------------------------------|
| 698.00 | <input checked="" type="checkbox"/> | <input type="checkbox"/> |
| 699.00 | <input type="checkbox"/> | <input checked="" type="checkbox"/> |

■ Aplicación / ■ Application / ■ Anwendung / ■ Application

IVECO EURO CARGO 03 →



(E)

| REF. | | |
|--------|-------------------------------------|-------------------------------------|
| 656.00 | <input checked="" type="checkbox"/> | <input checked="" type="checkbox"/> |

■ Aplicación / ■ Application // ■ Anwendung // ■ Application

IVECO EURO STAR 93 - 02



(E)

| REF. | | |
|--------|-------------------------------------|-------------------------------------|
| 592.00 | <input checked="" type="checkbox"/> | <input type="checkbox"/> |
| 593.00 | <input type="checkbox"/> | <input checked="" type="checkbox"/> |

■ Aplicación / ■ Application / ■ Anwendung / ■ Application

IVECO EURO TECH 93 - 02



(E)

| REF. | | |
|--------|-------------------------------------|-------------------------------------|
| 594.00 | <input checked="" type="checkbox"/> | <input type="checkbox"/> |
| 595.00 | <input type="checkbox"/> | <input checked="" type="checkbox"/> |

Pilotos Delanteros Front Lamps

Vorne Rücklicht Feux Avant

■ Aplicación / ■ Application / ■ Anwendung / ■ Application

IVECO STRALIS 03 →



(E)

| REF. | | |
|--------|-------------------------------------|-------------------------------------|
| 596.00 | <input checked="" type="checkbox"/> | <input type="checkbox"/> |
| 597.00 | <input type="checkbox"/> | <input checked="" type="checkbox"/> |

■ Aplicación / ■ Application / ■ Anwendung / ■ Application

MAN 96 →



(E)

| REF. | | |
|--------|-------------------------------------|-------------------------------------|
| 637.00 | <input checked="" type="checkbox"/> | <input checked="" type="checkbox"/> |

■ Aplicación / ■ Application / ■ Anwendung / ■ Application

MERCEDES VITO 96 - 03



(E)

| REF. | | |
|--------|-------------------------------------|-------------------------------------|
| 623.00 | <input checked="" type="checkbox"/> | <input type="checkbox"/> |
| 624.00 | <input type="checkbox"/> | <input checked="" type="checkbox"/> |

■ Aplicación / ■ Application / ■ Anwendung / ■ Application

MERCEDES VITO 96 - 03



(E)

| REF. | | |
|--------|-------------------------------------|-------------------------------------|
| 604.00 | <input checked="" type="checkbox"/> | <input type="checkbox"/> |
| 605.00 | <input type="checkbox"/> | <input checked="" type="checkbox"/> |

Pilotos Delanteros Front Lamps

Vorne Rücklicht Feux Avant

■ Aplicación / ■ Application / ■ Anwendung / ■ Application

SCANIA P/R/T 95 →



| REF. | | |
|--------|-------------------------------------|-------------------------------------|
| 633.00 | <input checked="" type="checkbox"/> | <input type="checkbox"/> |
| 634.00 | <input type="checkbox"/> | <input checked="" type="checkbox"/> |



(E)

■ Aplicación / ■ Application / ■ Anwendung / ■ Application

SCANIA R/P 07 →



| REF. | | |
|--------|-------------------------------------|-------------------------------------|
| 679.00 | <input checked="" type="checkbox"/> | <input checked="" type="checkbox"/> |



(E)

■ Aplicación / ■ Application / ■ Anwendung / ■ Application

VOLVO FH12 → 02



| REF. | | |
|--------|-------------------------------------|-------------------------------------|
| 697.00 | <input checked="" type="checkbox"/> | <input checked="" type="checkbox"/> |



(E)

■ Aplicación / ■ Application / ■ Anwendung / ■ Application

VOLVO FH12 98 - 02



| REF. | | |
|--------|-------------------------------------|-------------------------------------|
| 629.00 | <input checked="" type="checkbox"/> | <input checked="" type="checkbox"/> |

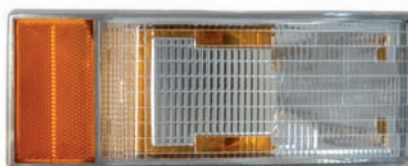

(E)

Pilotos Delanteros Front Lamps

Vorne Rücklicht Feux Avant

■ Aplicación / ■ Application / ■ Anwendung / ■ Application

VOLVO FL10



(E)

REF.



635.00

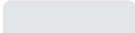

636.00

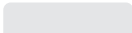

■ Aplicación / ■ Application / ■ Anwendung / ■ Application

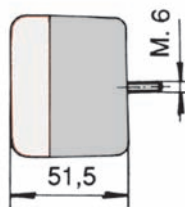

(A)

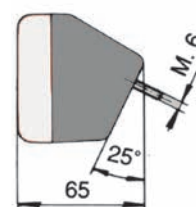

(B)

REF.



■ Intermitente
■ Indicator
■ Blinkleuchte
■ Clignotant

■ Posición
■ Position
■ Standlicht
■ Position

■ Tulipa
■ Lens
■ Linse
■ Caboçon

828.00

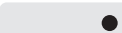
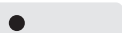

A

1227.11

832.00

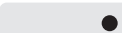
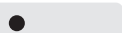

B

1227.11

833.00

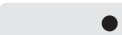
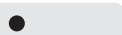
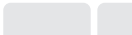

B

1227.11

(E)

Pilotos Traseros
Rear Lamps
Rücklicht
Feux Arrière

The importance of
being seen



Pilotos Traseros Rear Lamps

Rücklicht Feux Arrière



■ Aplicación / ■ Application / ■ Anwendung / ■ Application

UNIVERSAL



- Posición / Stop
- Intermitente
- Marcha Atrás
- Position / Stop
- Indicator
- Reverse
- Schlußleuchte / Stop
- Blinkleuchte
- Rückfahrt
- Position / Stop
- Clignotant
- Marche Arrière

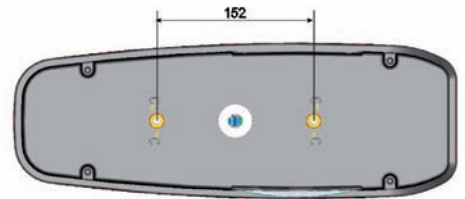
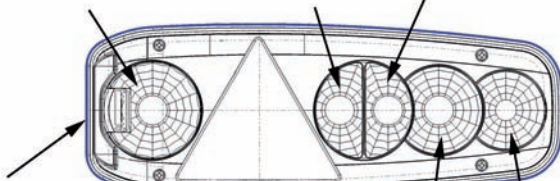

- Luz Posición Lateral / Reflex Lateral
- Side Marker Lamp / Side Reflex
- Seitenmarkierungsleuchte / Seitlicher Rückstrahler
- Feux Latéraux de Position / Catadioptré Latéral
- Luz Matrícula
- License Light
- Kennzeichenbeleuchte
- Eclairer de Plaques
- Niebla
- Fog
- Nebelschluß
- Brouillard
- Posición
- Position
- Schlußleuchte
- Position

| REF. | | | <ul style="list-style-type: none"> ■ Conector ■ Connector ■ Anschlußsystem ■ Connecteur | <ul style="list-style-type: none"> ■ Luz Matrícula ■ License Light ■ Kennzeichenleuchte ■ Eclairer de Plaques | <ul style="list-style-type: none"> ■ Alarma ■ Alarm ■ Alarm ■ Alarme | <ul style="list-style-type: none"> ■ Tulipa ■ Lens ■ Linse ■ Caboçon |
|--------|---|---|---|---|--|--|
| 734.00 | ● | | 1 | ● | | 4919.11 |
| 734.01 | ● | | 1 | ● | ● | 4919.11 |
| 734.05 | ● | | 1 | | | 4919.11 |
| 735.00 | | ● | 1 | ● | | 419.11 |
| 735.05 | | ● | 1 | | | 4919.11 |
| 734.20 | ● | | 2 | ● | | 4919.11 |
| 734.21 | ● | | 2 | ● | ● | 4919.11 |
| 734.25 | ● | | 2 | | | 4919.11 |
| 735.20 | | ● | 2 | ● | | 4919.11 |
| 735.25 | | ● | 2 | | | 4919.11 |
| 734.40 | ● | | 3 | ● | | 4919.11 |
| 734.41 | ● | | 3 | ● | ● | 4919.11 |
| 734.45 | ● | | 3 | | | 4919.11 |
| 735.40 | | ● | 3 | ● | | 4919.11 |
| 735.45 | | ● | 3 | | | 4919.11 |

1 PRENSAESTOPAS



2 AMP



3 UNIVERSAL



E

Pilotos Traseros Rear Lamps

Rücklicht Feux Arrière



■ Aplicación / ■ Application / ■ Anwendung / ■ Application

UNIVERSAL



- Posición / Stop
- Intermitente
- Marcha Atrás
- Position / Stop
- Reverse
- Rückfahrt
- Sluchbleuchte / Stop
- Blinkleuchte
- Rückfahrt
- Position / Stop
- Clignotant
- Marche Arrière

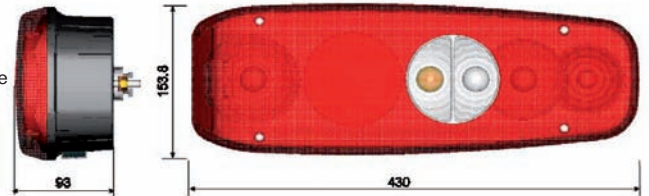
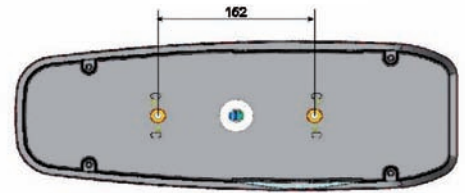
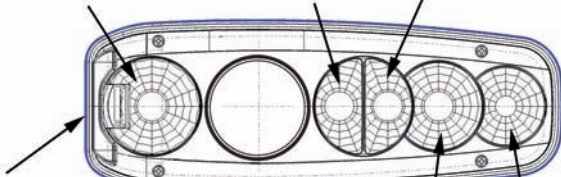

- Luz Posición Lateral / Reflex Lateral
- Side Marker Lamp / Side Reflex
- Seitenmarkierungsleuchte / Seitlicher Rückstrahler
- Feux Latéraux de Position / Catadioptré Latéral
- Luz Matricula
- License Light
- Kennzeichenbeleuchte
- Eclaireur de Plaques
- Niebla
- Fog
- Nebelschluß
- Brouillard
- Posición
- Position
- Schlußbleuchte
- Position

1

PRENSAESTOPAS



2

AMP



3

UNIVERSAL



E

| REF. | | | <ul style="list-style-type: none"> ■ Conector ■ Connector ■ Anschlußsystem ■ Connecteur | <ul style="list-style-type: none"> ■ Luz Matricula ■ License Light ■ Kennzeichenleuchte ■ Eclaireur de Plaques | <ul style="list-style-type: none"> ■ Alarma ■ Alarm ■ Alarm ■ Alarme | <ul style="list-style-type: none"> ■ Tulipa ■ Lens ■ Linse ■ Caboçon |
|--------|---|---|---|--|--|--|
| 736.00 | ● | | 1 | ● | | 4919.11 |
| 736.01 | ● | | 1 | ● | ● | 4919.11 |
| 736.05 | ● | ● | 1 | | | 4919.11 |
| 737.00 | | ● | 1 | ● | | 419.11 |
| 736.20 | ● | | 2 | ● | | 4919.11 |
| 736.21 | ● | | 2 | ● | ● | 4919.11 |
| 736.25 | ● | ● | 2 | | | 4919.11 |
| 737.20 | | ● | 2 | ● | | 4919.11 |
| 736.40 | ● | | 3 | ● | | 4919.11 |
| 736.41 | ● | | 3 | ● | ● | 4919.11 |
| 736.45 | ● | ● | 3 | | | 4919.11 |
| 737.40 | | ● | 3 | ● | | 4919.11 |

Pilotos Traseros Rear Lamps

Rücklicht Feux Arrière

■ Aplicación / ■ Application / ■ Anwendung / ■ Application



UNIVERSAL
LECIÑENA

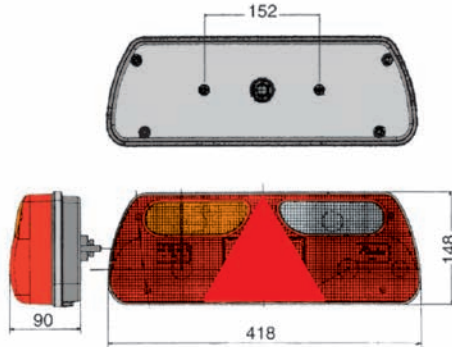

Universal

1

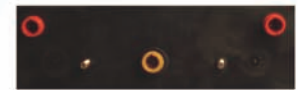

Leciñena

2

| REF. | | | ■ Conector ■ Connector ■ Anschlußsystem ■ Connecteur | ■ Luz Matrícula ■ License Light ■ Kennzeichenleuchte ■ Eclairer de Plaques | ■ Tulipa ■ Lens ■ Linse ■ Cabochon |
|--------|---|---|---|---|---|
| 760.00 | ● | | 1 | ● | 4643.11 |
| 761.00 | | ● | 1 | ● | 4644.11 |
| 760.05 | ● | | 2 | ● | 4643.11 |
| 761.05 | | ● | 2 | ● | 4644.11 |

E

■ Aplicación / ■ Application / ■ Anwendung / ■ Application



UNIVERSAL

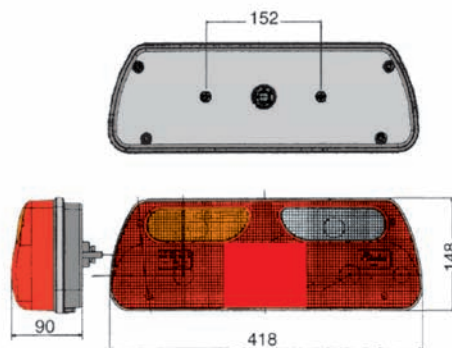

Universal

1

| REF. | | | ■ Conector ■ Connector ■ Anschlußsystem ■ Connecteur | ■ Luz Matrícula ■ License Light ■ Kennzeichenleuchte ■ Eclairer de Plaques | ■ Tulipa ■ Lens ■ Linse ■ Cabochon |
|--------|---|---|---|---|---|
| 762.00 | ● | | 1 | ● | 4656.11 |
| 763.00 | | ● | 1 | ● | 4657.11 |

E

Pilotos Traseros Rear Lamps

Rücklicht Feux Arrière

■ Aplicación / ■ Application / ■ Anwendung / ■ Application

UNIVERSAL
SCANIA
MAN
IVECO

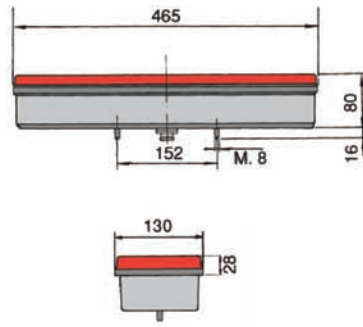

Universal

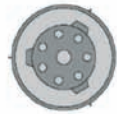

Schlemmer



1



2

| REF. | | | ■ Conector ■ Connector ■ Anschlußsystem ■ Connecteur | ■ Luz Matrícula ■ License Light ■ Kennzeichenleuchte ■ Eclairer de Plaques | ■ Luz Pos. Lateral ■ Side Marker Lamp ■ Seitenmarkierungsleuchte ■ Feux Latéraux de Position | ■ Catadióptico Lat. ■ Side Reflector ■ Seitlicher Rückstrahler ■ Catadioptré Latéral | ■ Tulipa ■ Lens ■ Linse ■ Caboçon |
|--------|---|---|---|---|---|---|--|
| 785.00 | ● | | 1 | ● | ● | ● | 4448.11 |
| 785.10 | ● | | 1 | ● | ● | ● | 4532.11 |
| 786.00 | | ● | 1 | ● | ● | ● | 4448.11 |
| 786.10 | | ● | 1 | ● | ● | ● | 4532.11 |
| 787.00 | ● | | 2 | ● | ● | ● | 4448.11 |
| 787.10 | ● | | 2 | ● | ● | ● | 4532.11 |
| 788.00 | | ● | 2 | ● | ● | ● | 4448.11 |
| 788.10 | | ● | 2 | ● | ● | ● | 4532.11 |
| 876.00 | ● | ● | 2 | ● | | | 4448.11 |
| 876.10 | ● | ● | 2 | ● | | | 4532.11 |
| 877.00 | ● | ● | 1 | ● | | | 4448.11 |
| 877.10 | ● | ● | 1 | ● | | | 4532.11 |

■ Aplicación / ■ Application / ■ Anwendung / ■ Application

UNIVERSAL
RENAULT

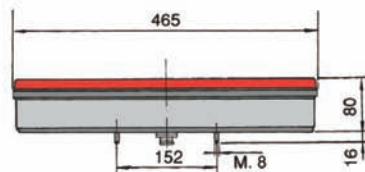

Universal



E

| REF. | | | ■ Luz Matrícula ■ License Light ■ Kennzeichenleuchte ■ Eclairer de Plaques | ■ Tulipa ■ Lens ■ Linse ■ Caboçon |
|--------|---|---|---|--|
| 842.00 | ● | | ● | 4449.11 |
| 844.00 | | ● | ● | 4449.11 |

Pilotos Traseros Rear Lamps

Rücklicht Feux Arrière

■ Aplicación / ■ Application / ■ Anwendung / ■ Application

UNIVERSAL

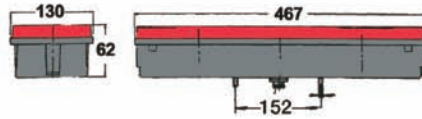

Universal



1

| REF. | | | ■ Conector ■ Connector ■ Anschlußsystem ■ Connecteur | ■ Luz Matrícula ■ License Light ■ Kennzeichenleuchte ■ Eclairer de Plaques | | ■ Tulipa ■ Lens ■ Linse ■ Cabochon |
|--------|---|---|---|---|---|---|
| 756.00 | ● | | 1 | | ● | 4784.11 |
| 757.00 | | ● | 1 | ● | ● | 4785.11 |
| 756.50 | ● | | 1 | ● | ● | 4784.11 |

E

■ Aplicación / ■ Application / ■ Anwendung / ■ Application

UNIVERSAL

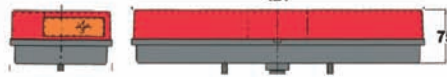
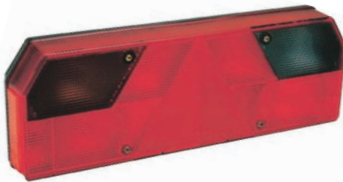

Universal



B

| REF. | | | ■ Conector ■ Connector ■ Anschlußsystem ■ Connecteur | ■ Luz Matrícula ■ License Light ■ Kennzeichenleuchte ■ Eclairer de Plaques | | ■ Tulipa ■ Lens ■ Linse ■ Cabochon |
|--------|---|---|---|---|---|---|
| 758.00 | ● | | 1 | ● | ● | 4782.10 |
| 759.00 | | ● | 1 | ● | ● | 4782.10 |
| 758.10 | ● | | 2 | ● | ● | 4782.10 |
| 759.10 | | ● | 2 | ● | ● | 4782.10 |

1

2

E

■ Aplicación / ■ Application / ■ Anwendung / ■ Application

MERCEDES ACTROS

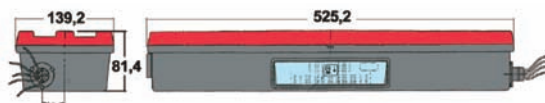

1



| REF. | | | ■ Conector ■ Connector ■ Anschlußsystem ■ Connecteur | ■ Luz Matrícula ■ License Light ■ Kennzeichenleuchte ■ Eclairer de Plaques | ■ Tulipa ■ Lens ■ Linse ■ Cabochon |
|--------|---|---|---|---|---|
| 985.00 | ● | | 1 | | 4780.11 |
| 986.00 | | ● | 1 | ● | 4791.11 |

E

Pilotos Traseros Rear Lamps

Rücklicht Feux Arrière

■ Aplicación / ■ Application / ■ Anwendung / ■ Application

MERCEDES ACTROS SK

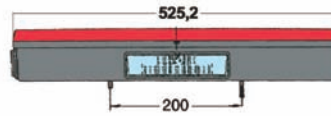
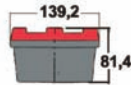

| REF. | | | ■ Conector ■ Connector ■ Anschlußsystem ■ Connecteur | ■ Luz Matrícula ■ License Light ■ Kennzeichenleuchte ■ Eclairer de Plaques | ■ Tulipa ■ Lens ■ Linse ■ Cabochon |
|--------|---|---|---|---|---|
| 987.00 | ● | | 1 | | 4780.11 |
| 988.00 | | ● | 1 | ● | 4791.11 |

■ Aplicación / ■ Application / ■ Anwendung / ■ Application

VOLVO II

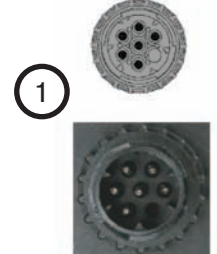
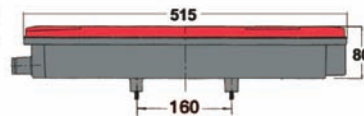
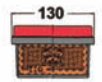

| REF. | | | ■ Conector ■ Connector ■ Anschlußsystem ■ Connecteur | ■ Luz Matrícula ■ License Light ■ Kennzeichenleuchte ■ Eclairer de Plaques | ■ Tulipa ■ Lens ■ Linse ■ Cabochon |
|--------|---|---|---|---|---|
| 783.00 | ● | | 1 | | 4781.11 |
| 784.00 | | ● | 1 | ● | 4781.11 |

■ Aplicación / ■ Application / ■ Anwendung / ■ Application

UNIVERSAL
SCANIA II

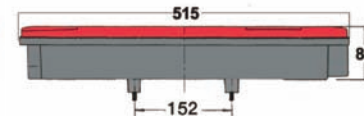

| REF. | | | ■ Conector ■ Connector ■ Anschlußsystem ■ Connecteur | ■ Luz Matrícula ■ License Light ■ Kennzeichenleuchte ■ Eclairer de Plaques | ■ Tulipa ■ Lens ■ Linse ■ Cabochon |
|--------|---|---|---|---|---|
| 778.00 | ● | | 1 | | 4781.11 |
| 779.00 | | ● | 1 | ● | 4781.11 |

Pilotos Traseros Rear Lamps

Rücklicht Feux Arrière

■ Aplicación / ■ Application / ■ Anwendung / ■ Application

MAN II
RENAULT II
DAF II

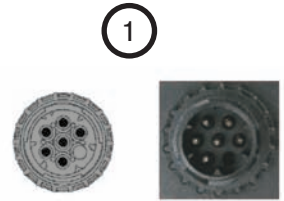
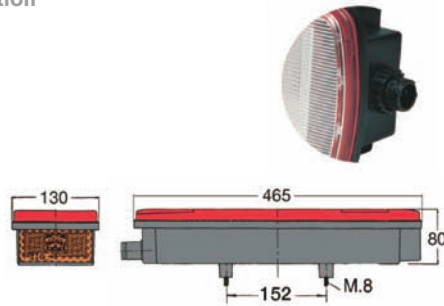

| REF. | | | ■ Conector ■ Connector ■ Anschlußsystem ■ Connecteur | ■ Luz Matrícula ■ License Light ■ Kennzeichenleuchte ■ Eclairer de Plaques | ■ Tulipa ■ Lens ■ Linse ■ Cabochon |
|--------|---|---|---|---|---|
| 738.00 | ● | | 1 | | 4448.11 |
| 739.00 | | ● | 1 | ● | 4448.11 |

(E)

■ Aplicación / ■ Application / ■ Anwendung / ■ Application

VOLVO

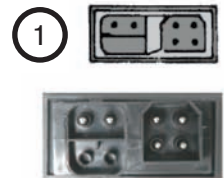
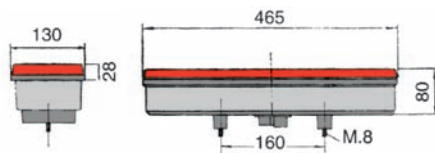

| REF. | | | ■ Conector ■ Connector ■ Anschlußsystem ■ Connecteur | ■ Luz Matrícula ■ License Light ■ Kennzeichenleuchte ■ Eclairer de Plaques | ■ Tulipa ■ Lens ■ Linse ■ Cabochon |
|--------|---|---|---|---|---|
| 797.00 | ● | | 1 | | 4448.11 |
| 798.00 | | ● | 1 | ● | 4448.11 |

(E)

■ Aplicación / ■ Application / ■ Anwendung / ■ Application

IVECO

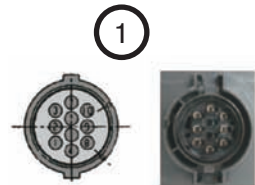
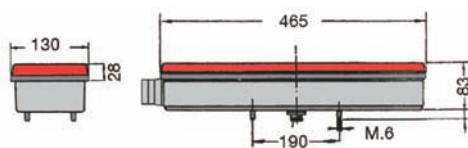

| REF. | | | ■ Conector ■ Connector ■ Anschlußsystem ■ Connecteur | ■ Luz Matrícula ■ License Light ■ Kennzeichenleuchte ■ Eclairer de Plaques | ■ Tulipa ■ Lens ■ Linse ■ Cabochon |
|--------|---|---|---|---|---|
| 924.00 | ● | | 1 | | 4670.11 |
| 925.00 | | ● | 1 | ● | 4670.11 |

(E)

Pilotos Traseros Rear Lamps

Rücklicht Feux Arrière

■ Aplicación / ■ Application / ■ Anwendung / ■ Application



DAF

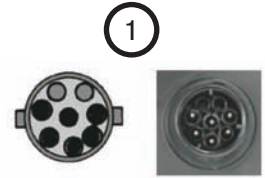
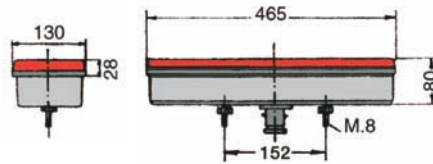

| REF. | | | ■ Conector ■ Connector ■ Anschlußsystem ■ Connecteur | ■ Luz Matrícula ■ License Light ■ Kennzeichenleuchte ■ Eclairer de Plaques | ■ Tulipa ■ Lens ■ Linse ■ Cabochon |
|--------|---|---|---|---|---|
| 929.00 | ● | | 1 | | 4448.11 |
| 930.00 | | ● | 1 | ● | 4448.11 |

(E)

■ Aplicación / ■ Application / ■ Anwendung / ■ Application



UNIVERSAL
MERCEDES SPRINTER
MERCEDES ATEGO

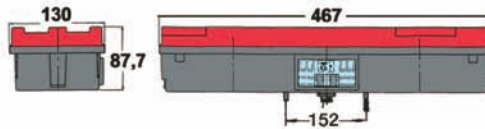
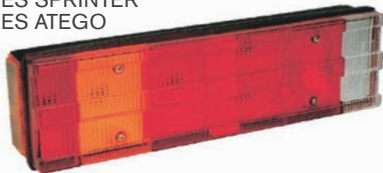

Sprinter

Atego

| REF. | | | ■ Conector ■ Connector ■ Anschlußsystem ■ Connecteur | ■ Luz Matrícula ■ License Light ■ Kennzeichenleuchte ■ Eclairer de Plaques | ■ Tulipa ■ Lens ■ Linse ■ Cabochon |
|--------|---|---|---|---|---|
| 981.00 | ● | | 1 | | 4777.11 |
| 982.00 | | ● | 1 | ● | 4777.11 |
| 981.10 | ● | | 2 | | 4777.11 |
| 982.10 | | ● | 2 | ● | 4777.11 |

(E)

■ Aplicación / ■ Application / ■ Anwendung / ■ Application

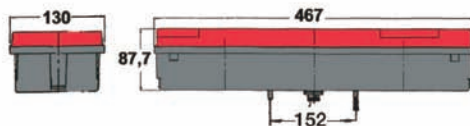

Schlemmer

| REF. | | | ■ Conector ■ Connector ■ Anschlußsystem ■ Connecteur | ■ Luz Matrícula ■ License Light ■ Kennzeichenleuchte ■ Eclairer de Plaques | ▲ | ■ Tulipa ■ Lens ■ Linse ■ Cabochon |
|--------|---|---|---|---|---|---|
| 979.00 | ● | | 1 | ● | ● | 4775.11 |
| 980.00 | | ● | 1 | ● | ● | 4776.11 |
| 979.50 | ● | | 1 | ● | ● | 4775.11 |

(E)

Pilotos Traseros Rear Lamps

Rücklicht Feux Arrière

■ Aplicación / ■ Application / ■ Anwendung / ■ Application

UNIVERSAL

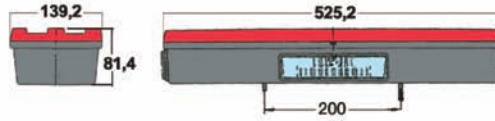
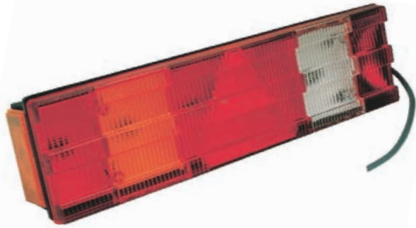

1 Universal



E

| REF. | | | ■ Conector ■ Connector ■ Anschlußsystem ■ Connecteur | ■ Luz Matrícula ■ License Light ■ Kennzeichenleuchte ■ Eclairer de Plaques | | ■ Tulipa ■ Lens ■ Linse ■ Caboçon |
|--------|---|---|---|---|---|--|
| 983.00 | ● | | 1 | | ● | 4778.11 |
| 984.00 | | ● | 1 | ● | ● | 4779.11 |
| 983.50 | ● | | 1 | ● | ● | 4778.11 |

■ Aplicación / ■ Application / ■ Anwendung / ■ Application

IVECO

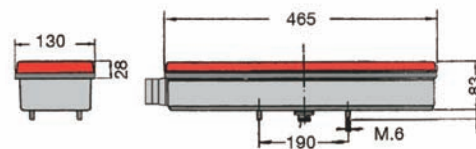

1



E

| REF. | | | ■ Conector ■ Connector ■ Anschlußsystem ■ Connecteur | ■ Luz Matrícula ■ License Light ■ Kennzeichenleuchte ■ Eclairer de Plaques | ■ Retroalarma ■ Retroalarm ■ Wieder Alarm ■ Alarme de Recul | ■ Tulipa ■ Lens ■ Linse ■ Caboçon |
|--------|---|---|---|---|--|--|
| 924.10 | ● | | 1 | | | 4448.11 |
| 925.10 | | ● | 1 | ● | ● | 4448.11 |

■ Aplicación / ■ Application / ■ Anwendung / ■ Application

MERCEDES ARTEGO

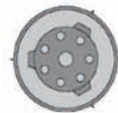
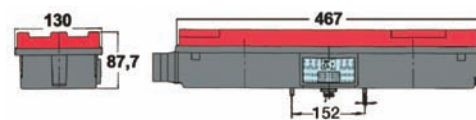

1



E

| REF. | | | ■ Conector ■ Connector ■ Anschlußsystem ■ Connecteur | ■ Luz Matrícula ■ License Light ■ Kennzeichenleuchte ■ Eclairer de Plaques | ■ Retroalarma ■ Retroalarm ■ Wieder Alarm ■ Alarme de Recul | ■ Tulipa ■ Lens ■ Linse ■ Caboçon |
|--------|---|---|---|---|--|--|
| 981.20 | ● | | 1 | | | 4777.11 |
| 982.20 | | ● | 1 | ● | ● | 4777.11 |

Pilotos Traseros Rear Lamps

Rücklicht Feux Arrière

■ Aplicación / ■ Application / ■ Anwendung / ■ Application

IVECO TURBOSTAR
IVECO EUROTECH

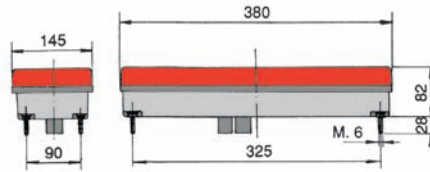

1 Eurotech



2 Turbostar

(E)

| REF. | | | ■ Conector ■ Connector ■ Anschlußsystem ■ Connecteur | ■ Luz Matrícula ■ License Light ■ Kennzeichenleuchte ■ Eclairer de Plaques | ■ Tulipa ■ Lens ■ Linse ■ Cabochoon |
|--------|---|---|---|---|--|
| 791.00 | ● | | 1 | | 4456.11 |
| 792.00 | | ● | 1 | ● | 4457.11 |
| 791.50 | ● | | 2 | | 4456.11 |
| 792.50 | | ● | 2 | ● | 4457.11 |

■ Aplicación / ■ Application / ■ Anwendung / ■ Application

UNIVERSAL

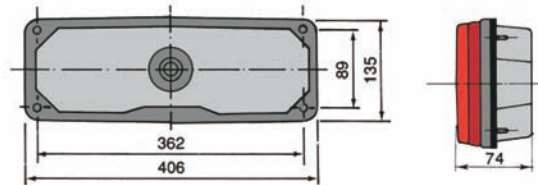
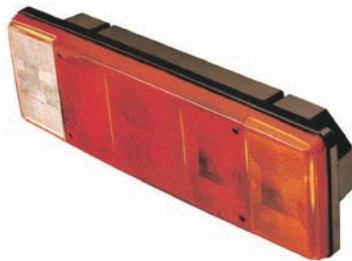

| REF. | | | ■ Tulipa ■ Lens ■ Linse ■ Cabochoon |
|--------|---|---|--|
| 922.00 | ● | | 1235.11 |
| 923.00 | | ● | 1235.11 |

■ Fijación 4 tornillos / ■ 4 Fijation Screws / ■ Vier Befestigungsschrauben / ■ Fixation 4 Vis

(E)

■ Aplicación / ■ Application / ■ Anwendung / ■ Application

UNIVERSAL

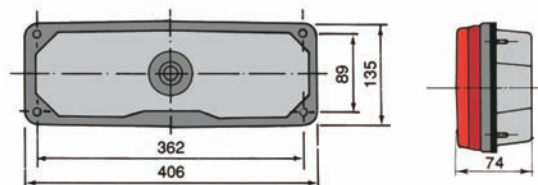

| REF. | | | ■ Tulipa ■ Lens ■ Linse ■ Cabochoon |
|--------|---|---|--|
| 922.09 | ● | | 1275.11 |
| 923.09 | | ● | 1275.11 |

■ Fijación 4 tornillos / ■ 4 Fijation Screws / ■ Vier Befestigungsschrauben / ■ Fixation 4 Vis

(E)

Pilotos Traseros Rear Lamps

Rücklicht Feux Arrière

■ Aplicación / ■ Application / ■ Anwendung / ■ Application



UNIVERSAL

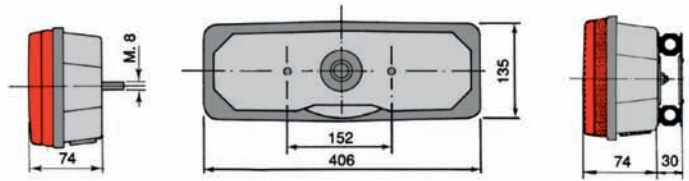

| REF. | | | ■ Luz Matrícula ■ License Light ■ Kennzeichenleuchte ■ Eclairer de Plaques | ■ Amortiguación ■ Silent Block ■ Dämpfung ■ Amortissement | ■ Catadióptrico ■ Réf. ex ■ Rückstrahler ■ Catadioptre | ■ Tulipa ■ Lens ■ Linse ■ Caboçon |
|--------|---|---|---|--|---|--|
| 915.00 | ● | | ● | | ● | 1235.11 |
| 916.00 | | ● | ● | | ● | 1235.11 |
| 917.00 | ● | | ● | ● | ● | 1235.11 |
| 918.00 | | ● | ● | ● | ● | 1235.11 |
| 935.00 | ● | | ● | | | 1260.11 |
| 936.00 | | ● | ● | | | 1260.11 |
| 937.00 | ● | | ● | ● | | 1260.11 |
| 938.00 | | ● | ● | ● | | 1260.11 |

■ Amortiguación / ■ Silent Block / ■ Dämpfung / ■ Amortissement REF. 4210.11

E

■ Aplicación / ■ Application / ■ Anwendung / ■ Application



UNIVERSAL
MERCEDES
MAN
VOLKSWAGEN

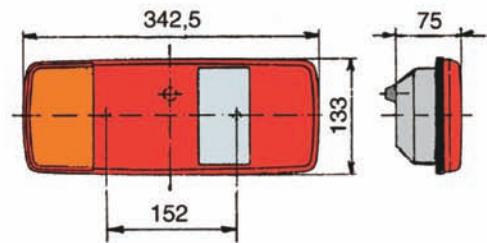
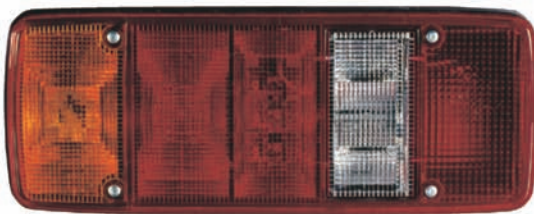

| REF. | | | ■ Luz Matrícula ■ License Light ■ Kennzeichenleuchte ■ Eclairer de Plaques | ■ Conector ■ Connector ■ Anschlußsystem ■ Connecteur | ■ Tulipa ■ Lens ■ Linse ■ Caboçon |
|--------|---|---|---|---|--|
| 770.00 | ● | | | Universal | 4557.11 |
| 771.00 | | ● | | Universal | 4557.11 |
| 772.00 | ● | | ● | Universal | 4557.11 |
| 773.00 | | ● | ● | Universal | 4557.11 |
| 721.00 | ● | | | Mercedes - MAN - VW | 4556.11 |
| 722.00 | | ● | | Mercedes - MAN - VW | 4556.11 |

E

Pilotos Traseros Rear Lamps

Rücklicht Feux Arrière

■ Aplicación / ■ Application / ■ Anwendung / ■ Application



VOLVO

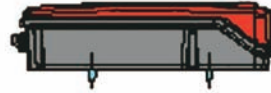

| REF. | | | ■ Conector ■ Connector ■ Anschlußsystem ■ Connecteur | ■ Luz Matrícula ■ License Light ■ Kennzeichenleuchte ■ Eclairer de Plaques | ■ Tulipa ■ Lens ■ Linse ■ Cabochon |
|--------|---|---|---|---|---|
| 725.00 | ● | | VOLVO | | 4565.11 |
| 726.00 | | ● | VOLVO | ● | 4565.11 |



■ Aplicación / ■ Application / ■ Anwendung / ■ Application



MAN

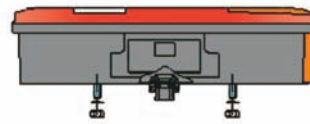
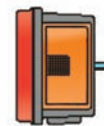
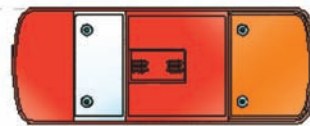

| REF. | | | ■ Conector ■ Connector ■ Anschlußsystem ■ Connecteur | ■ Luz Matrícula ■ License Light ■ Kennzeichenleuchte ■ Eclairer de Plaques | ■ Tulipa ■ Lens ■ Linse ■ Cabochon |
|--------|---|---|---|---|---|
| 727.00 | ● | | MAN | | 4566.11 |
| 728.00 | | ● | MAN | ● | 4566.11 |



■ Aplicación / ■ Application / ■ Anwendung / ■ Application



UNIVERSAL

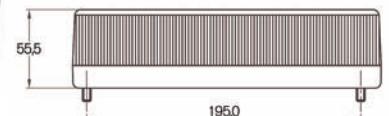
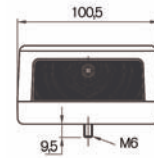
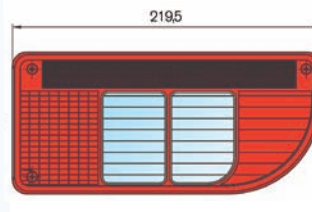

| REF. | | | ■ Niebla ■ Fog ■ Nebelschluß ■ Brouillard | ■ Marcha Atrás ■ Reverse ■ Rückfahrt ■ Marche Arrière | ■ Posición Stop ■ Position Stop ■ Sluchbleuchte Stop ■ Position Stop | ■ Intermitente ■ Indicator ■ Blinkleuchte ■ Clignotant | ■ Tulipa ■ Lens ■ Linse ■ Cabochon |
|--------|---|---|--|--|---|---|---|
| 974.00 | ● | | ● | ● | ● | ● | 4440.11 |
| 975.00 | | ● | ● | ● | ● | ● | 4441.11 |



■ Luz Matrícula / ■ Number Plate Light / ■ Autokennzeichenlicht / ■ Eclairer de Plaques

Pilotos Traseros Rear Lamps

Rücklicht Feux Arrière

■ Aplicación / ■ Application / ■ Anwendung / ■ Application



MAN
MERCEDES
IVECO

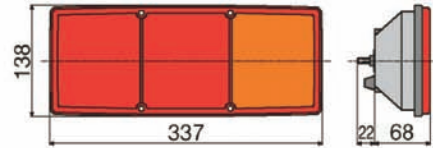

| REF. | | | ■ Luz Matrícula ■ License Light ■ Kennzeichenleuchte ■ Eclaireur de Plaques | ■ Tulipa ■ Lens ■ Linse ■ Cabochon |
|--------|---|---|--|---|
| 723.00 | ● | | | 4521.11 |
| 724.00 | | ● | ● | 4521.11 |



■ Aplicación / ■ Application / ■ Anwendung / ■ Application



FORD TRANSIT

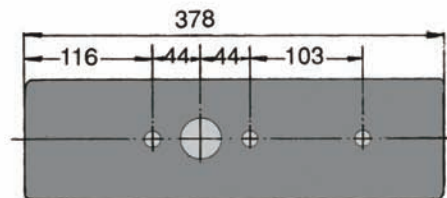

| REF. | | | ■ Tulipa ■ Lens ■ Linse ■ Cabochon |
|--------|---|---|---|
| 868.00 | ● | ● | 4450.11 |



■ Aplicación / ■ Application / ■ Anwendung / ■ Application



RENAULT
DAF

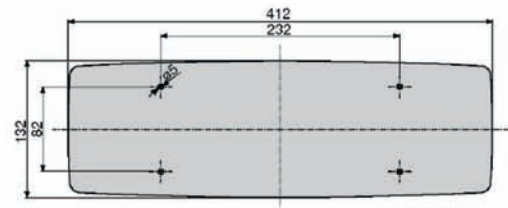

| REF. | | | ■ Tulipa ■ Lens ■ Linse ■ Cabochon |
|------|---|---|---|
| | ● | | 4539.11 |
| | | ● | 4539.11 |



Pilotos Traseros Rear Lamps

Rücklicht Feux Arrière

■ Aplicación / ■ Application / ■ Anwendung / ■ Application



UNIVERSAL

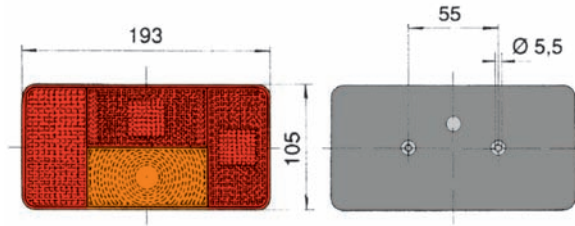
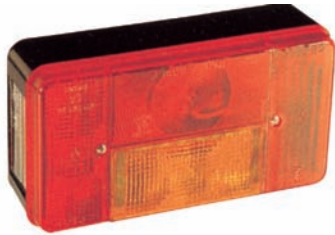

(E)

| REF. | | | ■ Niebla ■ Fog ■ Nebenschluß ■ Brouillard | ■ Marcha Atrás ■ Reverse ■ Rückfahrt ■ Marche Arrière | ■ Luz Matrícula ■ License Light ■ Kennzeichenleuchte ■ Eclairer de Plaques | ■ Catadióptico ■ Réf lex ■ Rückstrahler ■ Catadioptré | ■ Tulipa ■ Lens ■ Linse ■ Cabochon |
|--------|---|---|--|--|---|--|---|
| 160.00 | | ● | ● | | ● | | 4480.11 |
| 161.00 | ● | | ● | | ● | | 4481.11 |
| 162.00 | | ● | ● | | | | 4480.11 |
| 163.00 | ● | | | ● | | | 4483.11 |
| 164.00 | | ● | ● | | | ● | 4484.11 |
| 165.00 | ● | | | ● | | ● | 4485.11 |

■ Aplicación / ■ Application / ■ Anwendung / ■ Application



UNIVERSAL

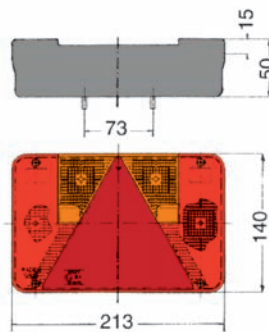

(E)

| REF. | | | ■ Niebla ■ Fog ■ Nebenschluß ■ Brouillard | ■ Marcha Atrás ■ Reverse ■ Rückfahrt ■ Marche Arrière | ■ Luz Matrícula ■ License Light ■ Kennzeichenleuchte ■ Eclairer de Plaques | ■ Catadióptico ■ Réf lex ■ Rückstrahler ■ Catadioptré | ■ Tulipa ■ Lens ■ Linse ■ Cabochon |
|--------|---|---|--|--|---|--|---|
| 145.00 | ● | | | ● | ● | ▲ | 4641.11 |
| 166.00 | | ● | ● | | ● | ▲ | 4673.11 |
| 167.00 | ● | | | | ● | ▲ | 4672.11 |

Pilotos Traseros Rear Lamps

Rücklicht Feux Arrière

■ Aplicación / ■ Application / ■ Anwendung / ■ Application

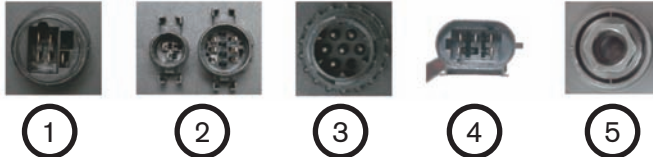
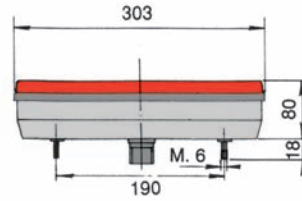
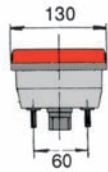

1. FIAT / IVECO
CITROEN
PEUGEOT
OPEL
2. FIAT
IVECO EUROCARGO
3. IVECO DAILY 99 →
4. RENAULT
5. UNIVERSAL

| REF. | | | ■ Niebla ■ Fog ■ Nebenschluß ■ Brouillard | ■ Marcha Atrás ■ Reverse ■ Rückfahrt ■ Marche Arrière | ■ Conector ■ Connector ■ Anschlußsystem ■ Connecteur | ■ Tulipa ■ Lens ■ Linse ■ Cabochon |
|--------|---|---|--|--|---|---|
| 793.00 | ● | | | ● | 1 | 4458.11 |
| 794.00 | | ● | ● | | 1 | 4459.11 |
| 793.10 | ● | | | ● | 2 | 4458.11 |
| 794.10 | | ● | ● | | 2 | 4459.11 |
| 793.20 | ● | | | ● | 3 | 4458.11 |
| 794.20 | | ● | ● | | 3 | 4459.11 |
| 793.30 | ● | | | ● | 4 | 4458.11 |
| 794.30 | | ● | ● | | 4 | 4459.11 |
| 793.40 | ● | | | ● | 5 | 4458.11 |
| 794.40 | | ● | ● | | 5 | 4459.11 |



■ Aplicación / ■ Application / ■ Anwendung / ■ Application



UNIVERSAL

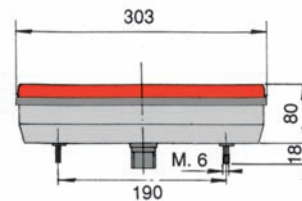
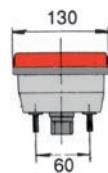

| REF. | | | ■ Niebla ■ Fog ■ Nebenschluß ■ Brouillard | ■ Marcha Atrás ■ Reverse ■ Rückfahrt ■ Marche Arrière | ■ Conector ■ Connector ■ Anschlußsystem ■ Connecteur | ▲ ■ Tulipa ■ Lens ■ Linse ■ Cabochon |
|--------|---|---|--|--|---|--|
| 793.50 | ● | | | ● | 5 | 4474.11 |
| 794.50 | | ● | ● | | 5 | 4475.11 |



Pilotos Traseros Rear Lamps

Rücklicht Feux Arrière

■ Aplicación / ■ Application / ■ Anwendung / ■ Application

FIAT DUCATO
CITROEN JUMPER
PEUGEOT BOXER



| REF. | | |
|--------|-------------------------------------|-------------------------------------|
| 781.00 | <input checked="" type="checkbox"/> | <input type="checkbox"/> |
| 782.00 | <input type="checkbox"/> | <input checked="" type="checkbox"/> |



(E)

■ Aplicación / ■ Application / ■ Anwendung / ■ Application

FIAT DUCATO
CITROEN JUMPER
PEUGEOT BOXER



| REF. | | |
|----------|-------------------------------------|-------------------------------------|
| 82600.00 | <input checked="" type="checkbox"/> | <input type="checkbox"/> |
| 82601.00 | <input type="checkbox"/> | <input checked="" type="checkbox"/> |



(E)

■ Aplicación / ■ Application / ■ Anwendung / ■ Application

IVECO DAILY 00 → 06



| REF. | | |
|----------|-------------------------------------|-------------------------------------|
| 82602.00 | <input checked="" type="checkbox"/> | <input type="checkbox"/> |
| 82603.00 | <input type="checkbox"/> | <input checked="" type="checkbox"/> |



(E)

■ Aplicación / ■ Application / ■ Anwendung / ■ Application

IRIZAR CENTURY



| REF. | | | ■ Posición Stop | ■ Intermitente | ■ Marcha Atrás |
|--------|-------------------------------------|-------------------------------------|--------------------------|--------------------------|--------------------------|
| | | | ■ Position Stop | ■ Indicator | ■ Reverse |
| | | | ■ Sluchbleuchte Stop | ■ Blinkleuchte | ■ Rückfahrt |
| | | | ■ Position Stop | ■ Clignotant | ■ Marche Arrière |
| 741.00 | <input checked="" type="checkbox"/> | <input type="checkbox"/> | <input type="checkbox"/> | <input type="checkbox"/> | <input type="checkbox"/> |
| 742.00 | <input type="checkbox"/> | <input checked="" type="checkbox"/> | <input type="checkbox"/> | <input type="checkbox"/> | <input type="checkbox"/> |



(E)

Pilotos Traseros Rear Lamps

Rücklicht Feux Arrière

■ Aplicación / ■ Application / ■ Anwendung / ■ Application

FORD TRANSIT MK6 00 - 06



| REF. | | |
|----------|-------------------------------------|-------------------------------------|
| 82604.00 | <input checked="" type="checkbox"/> | <input type="checkbox"/> |
| 82605.00 | <input type="checkbox"/> | <input checked="" type="checkbox"/> |



■ Aplicación / ■ Application / ■ Anwendung / ■ Application

FIAT SCUDO 95 → 03
PEUGEOT EXPERT
CITROEN



| REF. | | |
|----------|-------------------------------------|-------------------------------------|
| 82606.00 | <input checked="" type="checkbox"/> | <input type="checkbox"/> |
| 82607.00 | <input type="checkbox"/> | <input checked="" type="checkbox"/> |



■ Aplicación / ■ Application / ■ Anwendung / ■ Application

MERCEDES SPRINTER 95 → 02



| REF. | | |
|----------|-------------------------------------|-------------------------------------|
| 82608.00 | <input checked="" type="checkbox"/> | <input type="checkbox"/> |
| 82609.00 | <input type="checkbox"/> | <input checked="" type="checkbox"/> |



■ Aplicación / ■ Application / ■ Anwendung / ■ Application

MERCEDES SPRINTER 02 → 06



| REF. | | |
|----------|-------------------------------------|-------------------------------------|
| 82610.00 | <input checked="" type="checkbox"/> | <input type="checkbox"/> |
| 82611.00 | <input type="checkbox"/> | <input checked="" type="checkbox"/> |



Pilotos Traseros Rear Lamps

Rücklicht Feux Arrière

■ Aplicación / ■ Application / ■ Anwendung / ■ Application

UNIVERSAL

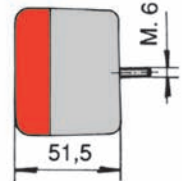
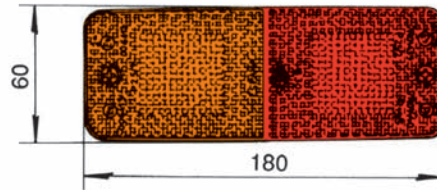

| REF. | | | ■ Luz Matrícula ■ License Light ■ Kennzeichenleuchte ■ Eclairer de Plaques | ■ Intermitente ■ Indicator ■ Blinkleuchte ■ Clignotant | ■ Posición Stop ■ Position Stop ■ Schlußleuchte Stop ■ Position Stop | ■ Tulipa ■ Lens ■ Linse ■ Cabochon |
|--------|---|---|---|---|---|---|
| 827.00 | ● | ● | | ● | ● | 1230.11 |
| 829.00 | ● | ● | ● | ● | ● | 1230.11 |

(E)

■ Aplicación / ■ Application / ■ Anwendung / ■ Application

UNIVERSAL

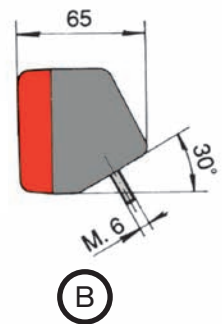
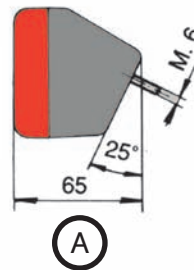

| REF. | | | ■ Luz Matrícula ■ License Light ■ Kennzeichenleuchte ■ Eclairer de Plaques | ■ Intermitente ■ Indicator ■ Blinkleuchte ■ Clignotant | ■ Posición Stop ■ Position Stop ■ Schlußleuchte Stop ■ Position Stop | ■ Tipo ■ Type ■ Typ ■ Type | ■ Tulipa ■ Lens ■ Linse ■ Cabochon |
|--------|---|---|---|---|---|-------------------------------------|---|
| 830.00 | ● | | | ● | ● | A | 1230.11 |
| 831.00 | | ● | | ● | ● | A | 1230.11 |
| 834.00 | ● | | | ● | ● | B | 1230.11 |
| 835.00 | | ● | ● | ● | ● | B | 1230.11 |

(E)

Pilotos Traseros Rear Lamps

Rücklicht Feux Arrière

■ Aplicación / ■ Application / ■ Anwendung / ■ Application



UNIVERSAL

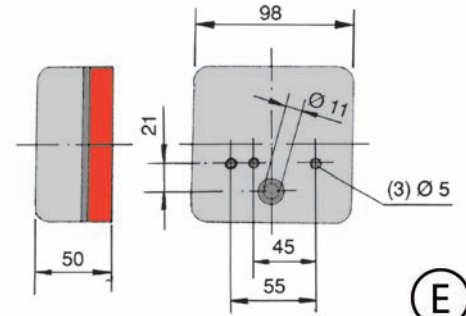

(E)

| REF. | Luz Vertical Vertical Light Verticale Licht Feu vertical | Luz Horizontal Horizontal Light Horizontale Licht Feu horizontal | Luz Matrícula License Light Kennzeichenleuchte Eclairer de Plaques | Intermitente Indicator Blinkleuchte Clignotant | Posición Stop Position Stop Schlußleuchte Stop Position Stop | Tulipa Lens Linse Cabocon |
|--------|---|---|---|---|---|------------------------------------|
| 874.00 | ● | ● | ● | ● | ● | 4488.11 |

■ Aplicación / ■ Application / ■ Anwendung / ■ Application



UNIVERSAL

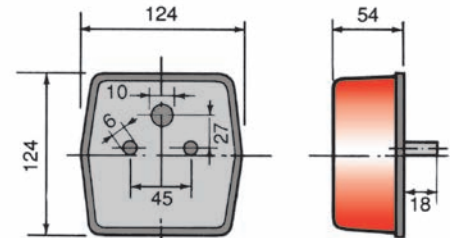

(E)

| REF. | Luz Matrícula License Light Kennzeichenleuchte Eclairer de Plaques | Intermitente Indicator Blinkleuchte Clignotant | Posición Position Schlußleuchte Position | Stop Stop Stop Stop | Tulipa Lens Linse Cabocon |
|--------|---|---|---|------------------------------|------------------------------------|
| 890.00 | ● | ● | ● | ● | 1233.11 |
| 892.00 | ● | ● | ● | ● | 1264.11 |

■ Aplicación / ■ Application / ■ Anwendung / ■ Application



UNIVERSAL

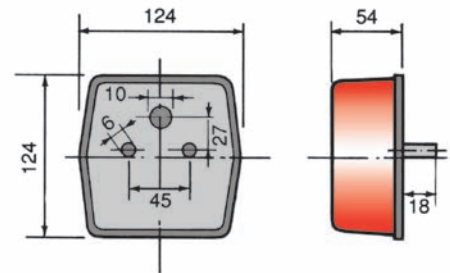

(E)

| REF. | Luz Matrícula License Light Kennzeichenleuchte Eclairer de Plaques | Intermitente Indicator Blinkleuchte Clignotant | Posición Position Standlicht Position | Stop Stop Stop Stop | Tulipa Lens Linse Cabocon |
|--------|---|---|--|------------------------------|------------------------------------|
| 891.00 | ● | ● | ● | ● | 1234.11 |

Pilotos Traseros Rear Lamps

Rücklicht Feux Arrière

■ Aplicación / ■ Application / ■ Anwendung / ■ Application



UNIVERSAL

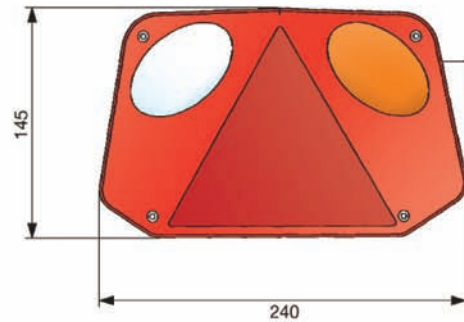

E

| REF. | | | ■ Niebla ■ Fog ■ Nebelschluß ■ Brouillard | ■ Marcha Atrás ■ Reverse ■ Rückfahrt ■ Marche Arrière | ■ Luz Matrícula ■ License Light ■ Kennzeichenleuchte ■ Eclairer de Plaques | ■ Catadióptrico ■ Réf lex ■ Rückstrahler ■ Catadioptre | ■ Tulipa ■ Lens ■ Linse ■ Cabochon |
|--------|---|---|--|--|---|---|---|
| 196.00 | | ● | ● | | ● | ▲ | 4584.11 |
| 197.00 | ● | | | ● | ● | ▲ | 4585.11 |
| 196.50 | | ● | ● | | | ▲ | 4584.11 |
| 197.50 | ● | | | ● | | ▲ | 4585.11 |

■ Aplicación / ■ Application / ■ Anwendung / ■ Application



UNIVERSAL

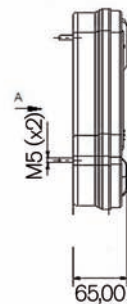
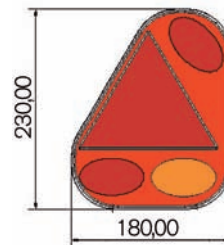

E

| REF. | | | ■ Niebla ■ Fog ■ Nebelschluß ■ Brouillard | ■ Marcha Atrás ■ Reverse ■ Rückfahrt ■ Marche Arrière | ■ Luz Matrícula ■ License Light ■ Kennzeichenleuchte ■ Eclairer de Plaques | ■ Catadióptrico ■ Réf lex ■ Rückstrahler ■ Catadioptre | ■ Tulipa ■ Lens ■ Linse ■ Cabochon |
|--------|---|---|--|--|---|---|---|
| 198.00 | | ● | ● | | ● | ▲ | 4586.11 |
| 199.00 | ● | | | ● | ● | ▲ | 4587.11 |
| 198.50 | | ● | ● | | | ▲ | 4586.11 |
| 199.50 | ● | | | ● | | ▲ | 4587.11 |

Pilotos Traseros Rear Lamps

Rücklicht Feux Arrière



■ Aplicación / ■ Application / ■ Anwendung / ■ Application

UNIVERSAL

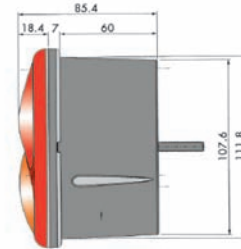
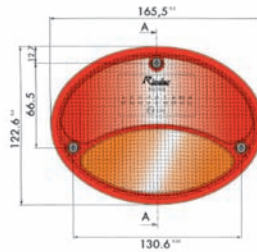
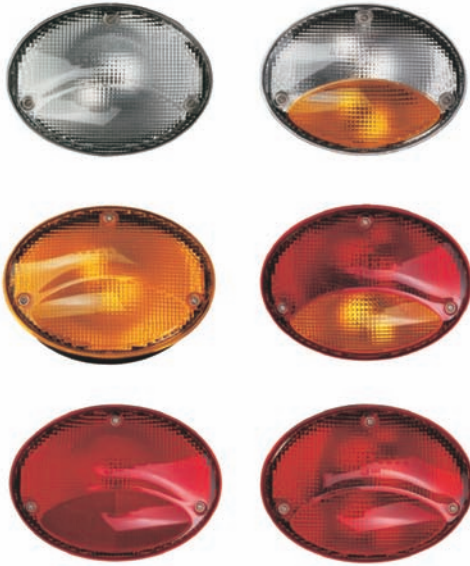

(E)

| REF. | ■ Posición Delantera ■ Front Position ■ Positions-leuchte ■ Position Avant | ■ Posición Trasera ■ Rear position ■ Schlußleuchte ■ Position Arrière | ■ Intermitente ■ Indicator ■ Blinkleuchte ■ Clignotant | ■ Stop ■ Stop ■ Stop ■ Stop | ■ Marcha Atrás ■ Reverse ■ Rückfahrt ■ Marche Arrière | ■ Niebla ■ Fog ■ Nebelschluß ■ Brouillard | ■ Reflex ■ Reflex ■ Reflex ■ Reflex | ■ Tulipa ■ Lens ■ Linse ■ Cabo-chon |
|--------|---|--|---|--------------------------------------|--|--|--|--|
| 952.00 | C | | | | | | | 4687.11 |
| 952.10 | A | | B | | | | | 4689.11 |
| 953.00 | | | C | | | | | 4688.11 |
| 954.00 | | C | | | | | | 4674.11 |
| 954.10 | | A | B | | | | | 4676.11 |
| 954.20 | | A | | A | | | | 4674.11 |
| 954.30 | | A | | | | | B | 4675.11 |
| 954.40 | | A/B | | | | | | 4674.11 |
| 956.00 | | | | C | | | | 4674.11 |
| 956.10 | | | B | A | | | | 4676.11 |
| 956.30 | | | | A | | | B | 4675.11 |
| 957.00 | | | | | | C | | 4674.11 |
| 957.10 | | | B | | | A | | 4676.11 |
| 958.00 | | | | | C | | | 4687.11 |
| 958.10 | | | B | | A | | | 4689.11 |
| 959.10 | | A | B | A | | | | 4676.11 |
| 959.30 | | A | | A | | | B | 4675.11 |
| 959.40 | | A/B | | A | | | | 4674.11 |

Pilotos Traseros Rear Lamps

Rücklicht Feux Arrière



■ Aplicación / ■ Application / ■ Anwendung / ■ Application

UNIVERSAL

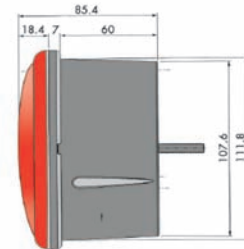
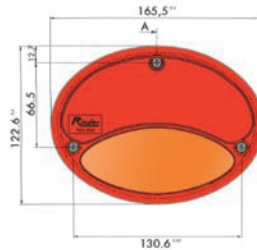

(E)

| REF. | ■ Posición Delantera ■ Front Position ■ Positionsleuchte ■ Position Avant | ■ Posición Trasera ■ Rear position ■ Schlußleuchte ■ Position Arrière | ■ Intermitente ■ Indicator ■ Blinkleuchte ■ Clignotant | ■ Stop ■ Stop ■ Stop ■ Stop | ■ Marcha Atrás ■ Reverse ■ Rückfahrt ■ Marche Arrière | ■ Niebla ■ Fog ■ Nebenschluß ■ Brouillard | ■ Reflex ■ Reflex ■ Reflex ■ Reflex | ■ Tulipa ■ Lens ■ Linse ■ Cabochon |
|--------|--|--|---|--------------------------------------|--|--|--|---|
| 552.00 | C | | | | | | | 4867.11 |
| 552.10 | A | | B | | | | | 4854.11 |
| 553.00 | | | C | | | | | 4868.11 |
| 554.00 | | C | | | | | | 4869.11 |
| 554.10 | | A | B | | | | | 4851.11 |
| 554.20 | | A | | A | | | | 4849.11 |
| 554.30 | | A | | | | | B | 4850.11 |
| 554.40 | | A/B | | | | | | 4849.11 |
| 556.00 | | | | C | | | | 4869.11 |
| 556.10 | | | B | A | | | | 4851.11 |
| 556.30 | | | | A | | | B | 4850.11 |
| 557.00 | | | | | | C | | 4869.11 |
| 557.10 | | | B | | | A | | 4851.11 |
| 558.00 | | | | | C | | | 4867.11 |
| 558.10 | | | B | | A | | | 4854.11 |
| 559.10 | | A | B | A | | | | 4851.11 |
| 559.30 | | A | | A | | | B | 4850.11 |
| 559.40 | | A/B | | A | | | | 4849.11 |

Pilotos Traseros Rear Lamps

Rücklicht Feux Arrière

■ Aplicación / ■ Application / ■ Anwendung / ■ Application



UNIVERSAL

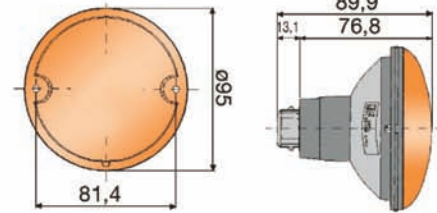

| REF. | Función / Function / Funktion / Fonction | | | | Conector / Connector / Anschlußsystem / Connecteur | | | Portalámparas / Bulbholders / Glühbirnen Halterung / Porte-Lampes | | |
|--------|---|---|---|---|--|---|---|---|---|-----|
| | ■ | ■ | ■ | ■ | ■ | ■ | ■ | ■ | ■ | ■ |
| 671.00 | Intermitente Delantero / Front indicator / Vor Blinkleuchte / Clignotant Avant | | | | 5344.11 | | | 3327.11 | | |
| 672.00 | Intermitente Trasero / Rear Indicator / Rückserte Blinkleuchte / Clignotant Arrière | | | | 5344.11 | | | 3327.11 | | |
| 673.00 | Posición Delantero / Front Position / Positionsleuchte / Position Avant | | | | 5344.11 | | | 3327.11 | | |
| 674.00 | Posición Trasera / Rear Position / Schlußleuchte / Position Arrière | | | | 5344.11 | | | 3327.11 | | |
| 675.00 | Stop / Stop / Stop / Stop | | | | 5344.11 | | | 3327.11 | | |
| 676.00 | Posición + Stop / Position + Stop / Schlußleuchte + Stop / Position + Stop | | | | 5345.11 | | | 3319.11 | | |
| 677.00 | Marcha Atrás / Reverse / Rückfahrt / Marche Arrière | | | | 5344.11 | | | 3327.11 | | |
| 678.00 | Antiniebla / Fog Lamp / Nebelschlußleuchte / Feux de Brouillard / | | | | 5344.11 | | | 3327.11 | | (E) |

■ Aplicación / ■ Application / ■ Anwendung / ■ Application



UNIVERSAL

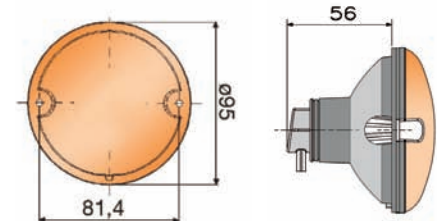

| REF. | Función / Function / Funktion / Fonction | | | | Portalámparas / Bulbholders / Glühbirnen Halterung / Porte-Lampes | | |
|--------|---|---|---|---|---|---|---|
| | ■ | ■ | ■ | ■ | ■ | ■ | ■ |
| 671.50 | Intermitente Delantero / Front indicator / Vor Blinkleuchte / Clignotant Avant | | | | 3329.11 | | |
| 672.50 | Intermitente Trasero / Rear Indicator / Rückserte Blinkleuchte / Clignotant Arrière | | | | 3329.11 | | |
| 673.50 | Posición Delantero / Front Position / Positionsleuchte / Position Avant | | | | 3329.11 | | |
| 674.50 | Posición Trasera / Rear Position / Schlußleuchte / Position Arrière | | | | 3329.11 | | |
| 675.50 | Stop / Stop / Stop / Stop | | | | 3329.11 | | |
| 676.50 | Posición + Stop / Position + Stop / Sluchleuchte + Stop / Position + Stop | | | | 3330.11 | | |
| 677.50 | Marcha Atrás / Reverse / Rückfahrt / Marche Arrière | | | | 3329.11 | | |
| 678.50 | Antiniebla / Fog Lamp / Nebelschlußleuchte / Feux de Brouillard / | | | | 3329.11 | | |

Pilotos Traseros Rear Lamps

Rücklicht Feux Arrière

■ Aplicación / ■ Application / ■ Anwendung / ■ Application



UNIVERSAL

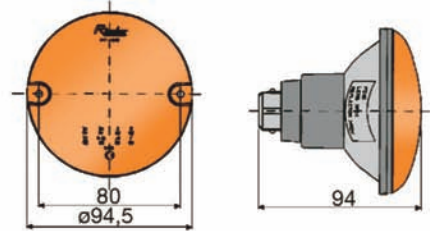

| REF. | Función / Function / Funktion / Fonction | | | | Conector / Connector / Anschlußsystem / Connecteur | | | Portalámparas / Bulbholders / Glühbirnen Halterung / Porte-Lampes | | |
|--------|---|---|---|---|--|---|---|---|---|-----|
| | ■ | ■ | ■ | ■ | ■ | ■ | ■ | ■ | ■ | ■ |
| 641.00 | Intermitente Delantero / Front indicator / Vor Blinkleuchte / Clignotant Avant | | | | 5344.11 | | | 3327.11 | | |
| 642.00 | Intermitente Trasero / Rear Indicator / Rückserte Blinkleuchte / Clignotant Arrière | | | | 5344.11 | | | 3327.11 | | |
| 643.00 | Posición Delantera / Front Position / Positionsleuchte / Position Avant | | | | 5344.11 | | | 3327.11 | | |
| 644.00 | Posición Trasera / Rear Position / Schlußleuchte / Position Arrière | | | | 5344.11 | | | 3327.11 | | |
| 645.00 | Stop / Stop / Stop / Stop | | | | 5344.11 | | | 3327.11 | | |
| 646.00 | Posición + Stop / Position + Stop / Sluchleuchte + Stop / Position + Stop | | | | 5345.11 | | | 3319.11 | | |
| 647.00 | Marcha Atrás / Reverse / Rückfahrt / Marche Arrière | | | | 5344.11 | | | 3327.11 | | |
| 648.00 | Antiniebla / Fog Lamp / Nebelschlußleuchte / Feux de Brouillard / | | | | 5344.11 | | | 3327.11 | | (E) |

■ Aplicación / ■ Application / ■ Anwendung / ■ Application



UNIVERSAL

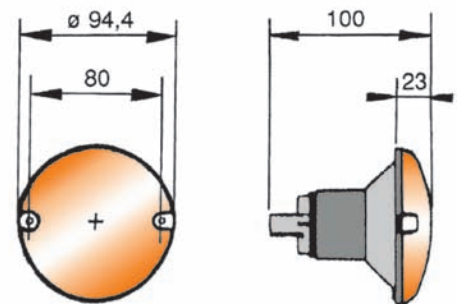

| REF. | Función / Function / Funktion / Fonction | | | | Conector / Connector / Anschlußsystem / Connecteur | | | Portalámparas / Bulbholders / Glühbirnen Halterung / Porte-Lampes | | |
|--------|---|---|---|---|--|---|---|---|---|-----|
| | ■ | ■ | ■ | ■ | ■ | ■ | ■ | ■ | ■ | ■ |
| 941.00 | Intermitente Delantero / Front indicator / Vor Blinkleuchte / Clignotant Avant | | | | 1718.11 | | | 3311.11 | | |
| 942.00 | Intermitente Trasero / Rear Indicator / Rückserte Blinkleuchte / Clignotant Arrière | | | | 1718.11 | | | 3311.11 | | |
| 943.00 | Posición Delantera / Front Position / Positionsleuchte / Position Avant | | | | 1718.11 | | | 3311.11 | | |
| 944.00 | Posición Trasera / Rear Position / Schlußleuchte / Position Arrière | | | | 1718.11 | | | 3311.11 | | |
| 945.00 | Stop / Stop / Stop / Stop | | | | 1718.11 | | | 3311.11 | | |
| 946.00 | Posición + Stop / Position + Stop / Sluchleuchte + Stop / Position + Stop | | | | 1719.11 | | | 3312.11 | | |
| 947.00 | Marcha Atrás / Reverse / Rückfahrt / Marche Arrière | | | | 1718.11 | | | 3311.11 | | |
| 948.00 | Antiniebla / Fog Lamp / Nebelschlußleuchte / Feux de Brouillard / | | | | 1718.11 | | | 3311.11 | | (E) |

Pilotos Traseros Rear Lamps

Rücklicht Feux Arrière

■ Aplicación / ■ Application / ■ Anwendung / ■ Application



UNIVERSAL



LED



E

| REF. | Tensión Voltage Spannung Tension | Stop Stop Stop Stop | Posición Position Schlußleuchte Position | Intermitente Indicator Blinkleuchte Clignotant | Marcha Atrás Reverse Rückfahrt Marche Arrière | Niebla Fog Nebenschluß Brouillard | Catadióptrico Rfl ex Rückstrahler Catadioptré |
|--------|---|------------------------------|---|---|--|--|--|
| 511.12 | 12V | ● | ● | ● | | | |
| 511.24 | 24V | ● | ● | ● | | | |
| 512.12 | 12V | | | | ● | ● | |
| 512.24 | 24V | | | | ● | ● | |
| 513.12 | 12V | | | | ● | | |
| 513.24 | 24V | | | | ● | | |
| 514.12 | 12V | | | | | ● | |
| 514.24 | 24V | | | | | ● | |
| 516.00 | | | | | | | ● |

■ Aplicación / ■ Application / ■ Anwendung / ■ Application



UNIVERSAL



LED

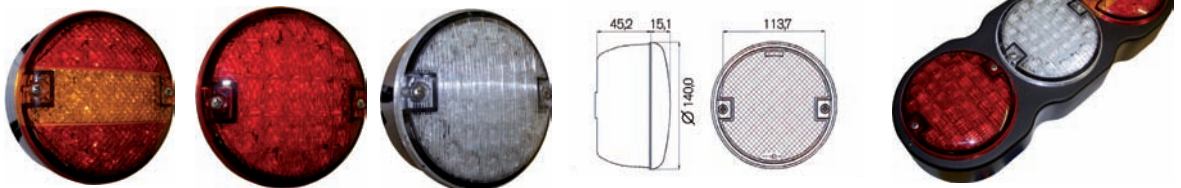

E

| REF. | Tensión Voltage Spannung Tension | Posición Stop Position Stop Schlußleuchte Stop Position Stop | Intermitente Indicator Blinkleuchte Clignotant | Marcha Atrás Reverse Rückfahrt Marche Arrière | Niebla Fog Nebenschluß Brouillard | Soporte Housing Hunterlage Support |
|--------|---|---|---|--|--|---|
| 517.12 | 12V | ● | ● | | | |
| 517.24 | 24V | ● | ● | | | |
| 518.12 | 12V | ● | | | | |
| 518.24 | 24V | ● | | | | |
| 519.12 | 12V | | | ● | | |
| 519.24 | 24V | | | ● | | |
| 520.12 | 12V | | | | ● | |
| 520.24 | 24V | | | | ● | |
| 521.00 | | | | | | ● |

Pilotos Traseros Rear Lamps

Rücklicht Feux Arrière



■ Aplicación / ■ Application / ■ Anwendung / ■ Application

UNIVERSAL

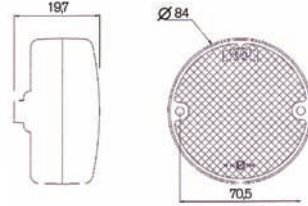

LED

| REF. | Tensión / Voltage / Spannung / Tension | | Posición Stop / Position Stop / Schlußleuchte Stop / Position Stop | | Intermitente / Indicator / Blinkleuchte / Clignotant | | Marcha Atrás / Reverse / Rückfahrt / Marche Arrière | | Niebla / Fog / Nebelschluß / Brouillard | | Color / Colour / Farbe / Couleur | |
|--------|--|-----|--|---|--|---|---|---|---|---|----------------------------------|---|
| | 12V | 24V | ● | ○ | ● | ○ | ● | ○ | ● | ○ | ● | ○ |
| 522.12 | 12V | | ● | | | | | | | | ● | |
| 522.24 | 24V | | ● | | | | | | | | ● | |
| 523.12 | 12V | | | | ● | | | | | | ○ | |
| 523.24 | 24V | | | | ● | | | | | | ○ | |
| 524.12 | 12V | | | | | | ● | | | | ○ | |
| 524.24 | 24V | | | | | | ● | | | | ○ | |
| 525.12 | 12V | | | | | | | | ● | | ● | |
| 525.24 | 24V | | | | | | | | ● | | ● | |

E

■ Aplicación / ■ Application / ■ Anwendung / ■ Application

UNIVERSAL

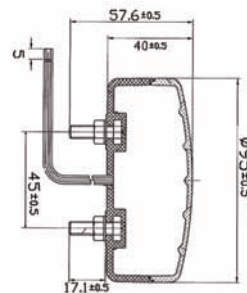

LED

| REF. | Tensión / Voltage / Spannung / Tension | | Intermitente Delantero / Front Indicator / Vor Blinkleuchte / Clignotant Avant | | Intermitente Posterior / Rear Indicator / Rückserte Blinkleuchte / Clignotant Arrière | | Posición Delantera / Front Position / Positionsleuchte / Position Avant | | Posición Trasera / Rear Position / Schlußleuchte / Position Arrière | |
|--------|--|-----|--|---|---|---|---|---|---|---|
| | 12V | 24V | ● | ○ | ● | ○ | ● | ○ | ● | ○ |
| 526.12 | 12V | | | | | | ● | | | |
| 526.24 | 24V | | | | | | ● | | | |
| 527.12 | 12V | | | | ● | | | | | ● |
| 527.24 | 24V | | | | ● | | | | | ● |

E

Pilotos Traseros Rear Lamps

Rücklicht Feux Arrière



■ Aplicación / ■ Application / ■ Anwendung / ■ Application

UNIVERSAL

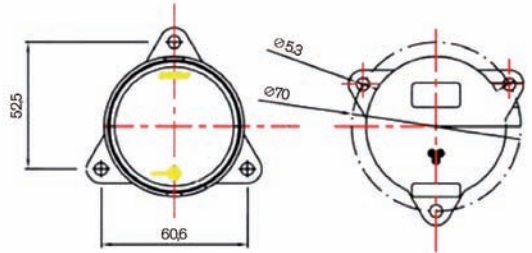

LED

| REF. | Tensión Voltage Spannung Tension | Posición Stop Position Stop Schlußleuchte Stop Position Stop | Intermitente Indicator Blinkleuchte Clignotant | Marcha Atrás Reverse Rückfahrt Marche Arrière | Niebla Fog Nebelschluß Brouillard | Color Colour Farbe Couleur |
|--------|---|---|---|--|--|-------------------------------------|
| 528.12 | 12V | ● | | | | ● |
| 528.24 | 24V | ● | | | | ● |
| 529.12 | 12V | | ● | | | ○ |
| 529.24 | 24V | | ● | | | ○ |
| 530.12 | 12V | | | | ● | ● |
| 530.24 | 24V | | | | ● | ● |
| 531.12 | 12V | | | ● | | ○ |
| 531.24 | 24V | | | ● | | ○ |

E

■ Aplicación / ■ Application / ■ Anwendung / ■ Application

UNIVERSAL

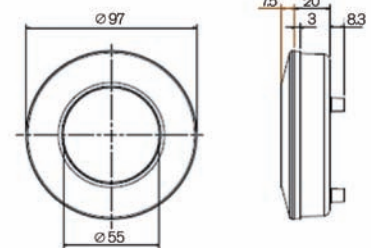

LED

| REF. | Tensión Voltage Spannung Tension | Posición Stop Position Stop Schlußleuchte Stop Position Stop | Intermitente Indicator Blinkleuchte Clignotant | Color Colour Farbe Couleur |
|--------|---|---|---|-------------------------------------|
| 532.12 | 12V | ● | | ● |
| 532.24 | 24V | ● | | ● |
| 532.52 | 12V | ● | | ○ |
| 532.64 | 24V | ● | | ○ |
| 533.12 | 12V | | ● | ○ |
| 533.24 | 24V | | ● | ○ |

E

Pilotos Traseros Rear Lamps

Rücklicht Feux Arrière

■ Aplicación / ■ Application / ■ Anwendung / ■ Application



UNIVERSAL

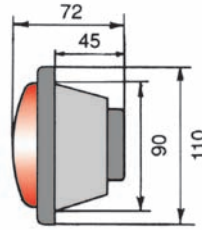

(E)

| REF. | ■ Posición Trasera ■ Rear Position ■ Schlußleuchte ■ Position Arrière | ■ Stop ■ Stop ■ Stop ■ Stop | ■ Posición Stop ■ Position Stop ■ Schlußleuchte Stop ■ Position Stop | ■ Intermitente lateral ■ Side Indicator ■ Seite-blinkeuchte ■ Clignotants Latéraux | ■ Intermitente Posterior ■ Rear Indicator ■ Rückserte Blinkleuchte ■ Clignotant Arrière | ■ Intermitente Delantero ■ Front Indicator ■ Vor Blinkleuchte ■ Clignotant Avant | ■ Posición Delantera ■ Front Position ■ Positions-leuchte ■ Position Avant | ■ Tulipa ■ Lens ■ Linse ■ Cabo-chon |
|--------|--|--------------------------------------|---|---|--|---|---|--|
| 859.00 | ● | | | | | | | 1215.11 |
| 860.00 | | ● | | | | | | 1218.11 |
| 861.00 | | | ● | | | | | 1216.11 |
| 858.00 | | | | ● | | | | 1220.11 |
| 862.00 | | | | | ● | | | 1217.11 |
| 863.00 | | | | | | ● | | 1222.11 |
| 864.00 | | | | | | | ● | 1219.11 |

■ Aplicación / ■ Application / ■ Anwendung / ■ Application



UNIVERSAL

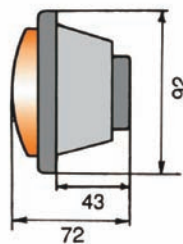

(E)

| REF. | ■ Posición Trasera ■ Rear Position ■ Schlußleuchte ■ Position Arrière | ■ Stop ■ Stop ■ Stop ■ Stop | ■ Posición Stop ■ Position Stop ■ Sluchbleuchte Stop ■ Position Stop | ■ Intermitente lateral ■ Side Indicator ■ Seite-blinkeuchte ■ Clignotants Latéraux | ■ Intermitente Posterior ■ Rear Indicator ■ Rückserte Blinkleuchte ■ Clignotant Arrière | ■ Intermitente Delantero ■ Front Indicator ■ Vor Blinkleuchte ■ Clignotant Avant | ■ Posición Delantera ■ Front Position ■ Positions-leuchte ■ Position Avant | ■ Tulipa ■ Lens ■ Linse ■ Cabo-chon |
|--------|--|--------------------------------------|---|---|--|---|---|--|
| 809.00 | ● | | | | | | | 1201.11 |
| 810.00 | | ● | | | | | | 1202.11 |
| 811.00 | | | ● | | | | | 1203.11 |
| 808.00 | | | | ● | | | | 1232.11 |
| 812.00 | | | | | ● | | | 1204.11 |
| 815.00 | | | | | | ● | | 1206.11 |
| 813.00 | | | | | | | ● | 1205.11 |

Pilotos Traseros Rear Lamps

Rücklicht Feux Arrière

■ Aplicación / ■ Application / ■ Anwendung / ■ Application



UNIVERSAL

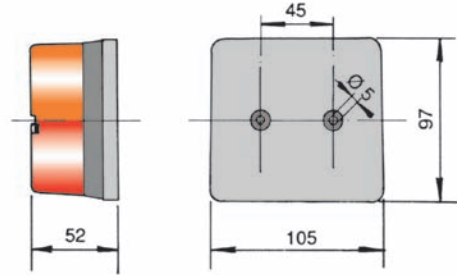

(E)

| REF. | Intermitente Indicator Blinkleuchte Clignotant | Luz Matricula License Light Kennzeichenleuchte Eclairer de Plaques | Posición Stop Position Stop Schlußleuchte Stop Position Stop | Posición Delantera Front Position Positionsleuchte Position Avant | Tulipa Lens Linse Cabocon |
|--------|---|---|---|--|------------------------------------|
| 818.00 | ● | | | ● | 1296.11 |
| 819.00 | ● | ● | ● | | 1297.11 |
| 820.00 | ● | | ● | | 1298.11 |

■ Aplicación / ■ Application / ■ Anwendung / ■ Application



UNIVERSAL

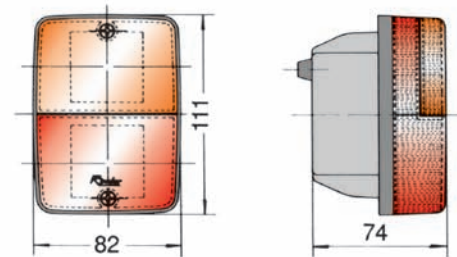

(E)

| REF. | Intermitente Indicator Blinkleuchte Clignotant | Posición Stop Position Stop Schlußleuchte Stop Position Stop | Posición Delantera Front Position Positionsleuchte Position Avant | Tulipa Lens Linse Cabocon |
|--------|---|---|--|------------------------------------|
| 851.00 | ● | ● | | 1281.11 |
| 852.00 | ● | | ● | 1282.11 |

Pilotos Traseros Rear Lamps

Rücklicht Feux Arrière

■ Aplicación / ■ Application / ■ Anwendung / ■ Application

UNIVERSAL

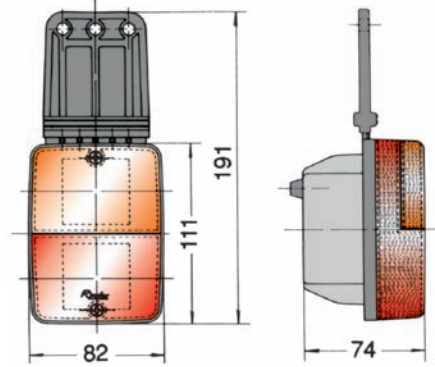

(E)

| REF. | Intermitente Indicator Blinkleuchte Clignotant | Posición Stop Position Stop Schlußleuchte Stop Position Stop | Tulipa Lens Linse Cabocon |
|--------|---|---|------------------------------------|
| 854.00 | ● | ● | 1281.11 |

■ Aplicación / ■ Application / ■ Anwendung / ■ Application

UNIVERSAL

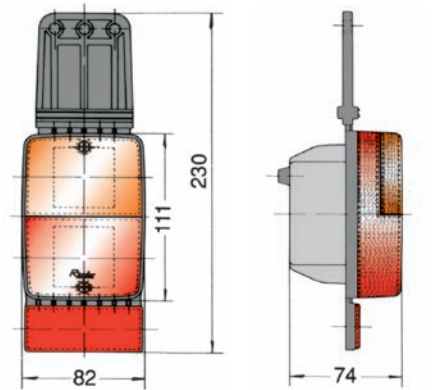

(E)

| REF. | Intermitente Indicator Blinkleuchte Clignotant | Posición Stop Position Stop Schlußleuchte Stop Position Stop | Catadióptrico Rél ex Rückstrahler Catadioptré | Tulipa Lens Linse Cabocon |
|--------|---|---|--|------------------------------------|
| 855.00 | ● | ● | ● | 1281.11 |

■ Aplicación / ■ Application / ■ Anwendung / ■ Application

UNIVERSAL

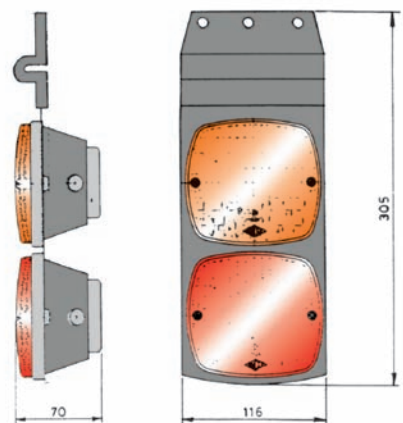

(E)

| REF. | Intermitente Indicator Blinkleuchte Clignotant | Posición Stop Position Stop Schlußleuchte Stop Position Stop |
|--------|---|---|
| 879.00 | 1217.11 | 1216.11 |

Pilotos Traseros Rear Lamps

Rücklicht Feux Arrière

■ Aplicación / ■ Application / ■ Anwendung / ■ Application

UNIVERSAL

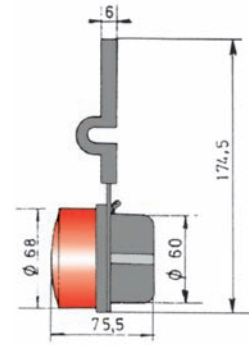

E

| REF. | ■ Posición ■ Position ■ Schlußleuchte ■ Position | ■ Posición Stop ■ Position Stop ■ Schlußleuchte Stop ■ Position Stop | ■ Tulipa ■ Lens ■ Linse ■ Cabochon |
|--------|---|---|---|
| 840.00 | ● | | 1209.11 |
| 841.00 | | ● | 1211.11 |

■ Aplicación / ■ Application / ■ Anwendung / ■ Application

UNIVERSAL

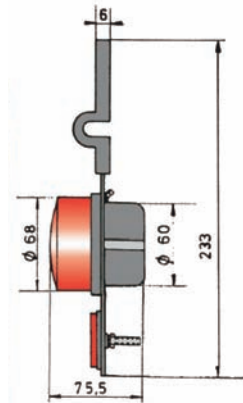

E

| REF. | ■ Posición Stop ■ Position Stop ■ Schlußleuchte Stop ■ Position Stop | ■ Catadióptrico ■ Réf ex ■ Rückstrahler ■ Catadioptré | ■ Tulipa ■ Lens ■ Linse ■ Cabochon |
|--------|---|--|---|
| 843.00 | ● | 768-R.00 | 1211.11 |

■ Aplicación / ■ Application / ■ Anwendung / ■ Application

UNIVERSAL

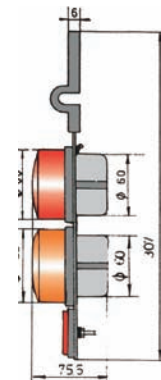

E

| REF. | ■ Posición Stop ■ Position Stop ■ Schlußleuchte Stop ■ Position Stop | ■ Intermitente ■ Indicator ■ Blinkleuchte ■ Clignotant | ■ Catadióptrico ■ Réf ex ■ Rückstrahler ■ Catadioptré | ■ Tulipa ■ Lens ■ Linse ■ Cabochon |
|--------|---|---|--|---|
| 845.00 | ● | ● | 768-R | ● 1211.11 ● 1212.11 |

high illumination

Luces de Posición
Position Lamps
Lichtraum
Feux de Position



Luces de Posición Position Lamps

Lichtraum Feux de Position

■ Aplicación / ■ Application / ■ Anwendung / ■ Application

UNIVERSAL

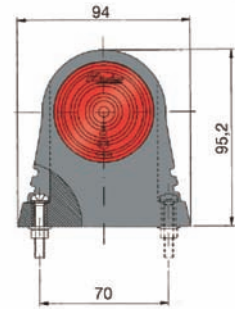

E

| | | | |
|--------|---------|-----------|------------------------|
| REF. | Color | 12/24V 5W | Tulipa |
| | Colour | | Lens |
| 620.00 | Farbe | ● | Linse |
| | Couleur | | Cabocho |
| | ● ○ | | ● 4898.11 ○ 4899.11 |

■ Aplicación / ■ Application / ■ Anwendung / ■ Application

UNIVERSAL

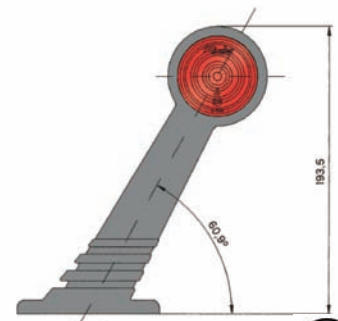

E

| | | | |
|--------|---------|-----------|------------------------|
| REF. | Color | 12/24V 5W | Tulipa |
| | Colour | | Lens |
| 621.00 | Farbe | ● | Linse |
| | Couleur | | Cabocho |
| | ● ○ | | ● 4898.11 ○ 4899.11 |

■ Aplicación / ■ Application / ■ Anwendung / ■ Application

UNIVERSAL

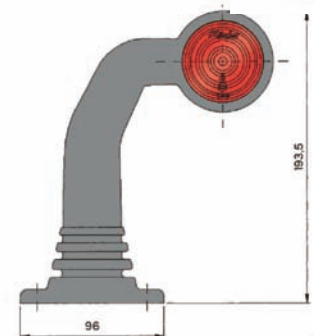

E

| | | | |
|--------|---------|-----------|------------------------|
| REF. | Color | 12/24V 5W | Tulipa |
| | Colour | | Lens |
| 622.00 | Farbe | ● | Linse |
| | Couleur | | Cabocho |
| | ● ○ | | ● 4898.11 ○ 4899.11 |

Luces de Posición Position Lamps

Lichtraum Feux de Position

■ Aplicación / ■ Application / ■ Anwendung / ■ Application

UNIVERSAL

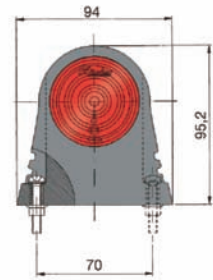

E

| | | | |
|--------|---------|-----------|------------------------|
| REF. | Color | 12/24V 5W | Tulipa |
| | Colour | | Lens |
| 620.01 | Farbe | ● | Linse |
| | Couleur | | Cabochon |
| | ● ○ | | ● 4898.11 ○ 4899.11 |

■ Aplicación / ■ Application / ■ Anwendung / ■ Application

UNIVERSAL

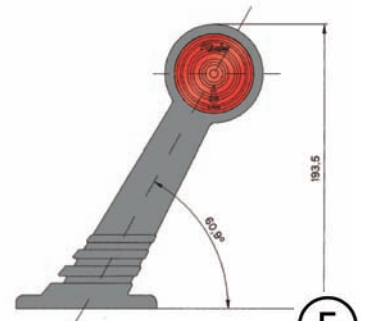

E

| | | | |
|--------|---------|-----------|------------------------|
| REF. | Color | 12/24V 5W | Tulipa |
| | Colour | | Lens |
| 621.01 | Farbe | ● | Linse |
| | Couleur | | Cabochon |
| | ● ○ | | ● 4898.11 ○ 4899.11 |

■ Aplicación / ■ Application / ■ Anwendung / ■ Application

UNIVERSAL

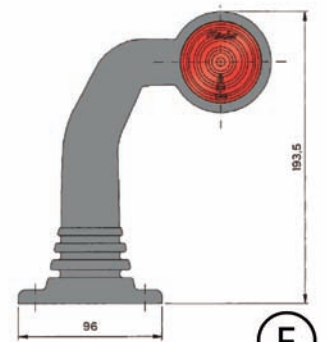

E

| | | | |
|--------|---------|-----------|------------------------|
| REF. | Color | 12/24V 5W | Tulipa |
| | Colour | | Lens |
| 622.01 | Farbe | ● | Linse |
| | Couleur | | Cabochon |
| | ● ○ | | ● 4898.11 ○ 4899.11 |

Luces de Posición Position Lamps

Lichtraum Feux de Position

■ Aplicación / ■ Application / ■ Anwendung / ■ Application

UNIVERSAL

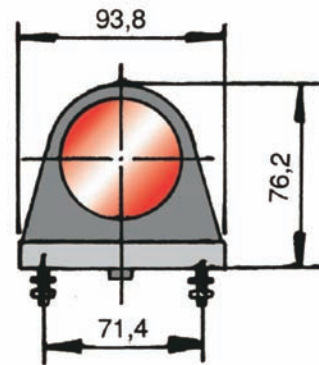

(E)

| | | | |
|--------|---------|-----------|------------------------|
| REF. | Color | 12/24V 5W | Tulipa |
| | Colour | | Lens |
| 615.00 | Farbe | ● | Linse |
| | Couleur | | Caboçon |
| | ● ○ | | ● 1256.11 ○ 1255.11 |

■ Aplicación / ■ Application / ■ Anwendung / ■ Application

UNIVERSAL

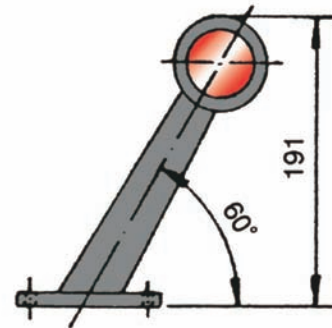

(E)

| | | | |
|--------|---------|-----------|------------------------|
| REF. | Color | 12/24V 5W | Tulipa |
| | Colour | | Lens |
| 616.00 | Farbe | ● | Linse |
| | Couleur | | Caboçon |
| | ● ○ | | ● 1256.11 ○ 1255.11 |

■ Aplicación / ■ Application / ■ Anwendung / ■ Application

UNIVERSAL

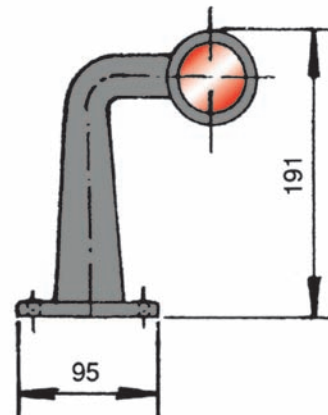

(E)

| | | | |
|--------|---------|-----------|------------------------|
| REF. | Color | 12/24V 5W | Tulipa |
| | Colour | | Lens |
| 617.00 | Farbe | ● | Linse |
| | Couleur | | Caboçon |
| | ● ○ | | ● 1256.11 ○ 1255.11 |

Luces de Posición Position Lamps

Lichtraum Feux de Position

■ Aplicación / ■ Application / ■ Anwendung / ■ Application

UNIVERSAL



(E)

| REF. | Color Colour Farbe Couleur | 12/24V 5W | LED 24V |
|--------|-------------------------------------|-----------|---------|
| 638.00 | ● ○ | ● | |
| 638.50 | ● ○ | | ● |

■ Aplicación / ■ Application / ■ Anwendung / ■ Application

UNIVERSAL



(E)

| REF. | Color Colour Farbe Couleur | 12/24V 5W | LED 24V |
|--------|-------------------------------------|-----------|---------|
| 639.00 | ● ○ | ● | |
| 639.50 | ● ○ | | ● |

■ Aplicación / ■ Application / ■ Anwendung / ■ Application

UNIVERSAL



(E)

| REF. | Color Colour Farbe Couleur | 12/24V 5W | LED 24V |
|--------|-------------------------------------|-----------|---------|
| 640.00 | ● ○ | ● | |
| 640.50 | ● ○ | | ● |

Luces de Posición Position Lamps

Lichtraum Feux de Position

■ Aplicación / ■ Application / ■ Anwendung / ■ Application

UNIVERSAL

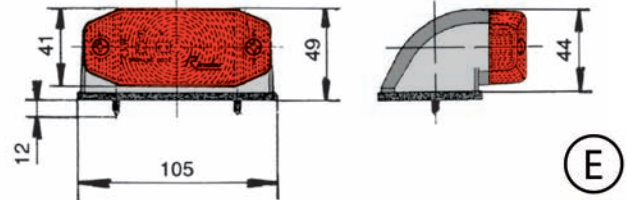

| REF. | Color Colour Farbe Couleur | 12/24V 5W | Tulipa Lens Linse Caboçon |
|--------|-------------------------------------|-----------|------------------------------------|
| 803.00 | ● | ● | 1286.11 |
| 804.00 | ○ | ● | 1287.11 |

■ Aplicación / ■ Application / ■ Anwendung / ■ Application

UNIVERSAL

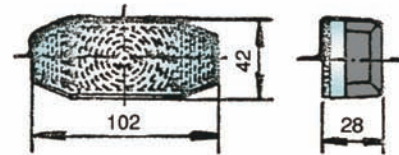

| REF. | Color Colour Farbe Couleur | 12/24V 5W | Tulipa Lens Linse Caboçon |
|----------|-------------------------------------|-----------|------------------------------------|
| 800.00 | ● | ● | 1286.11 |
| 801.00 | ○ | ● | 1287.11 |
| * 802.00 | ● | ● | 1288.11 |
| 799.00 | ● | ● | 1299.11 |

* ■ Intermitente Lateral / ■ Side Indicator / ■ Seiteblinkleuchte / ■ Clignotants Latéraux

■ Aplicación / ■ Application / ■ Anwendung / ■ Application

UNIVERSAL

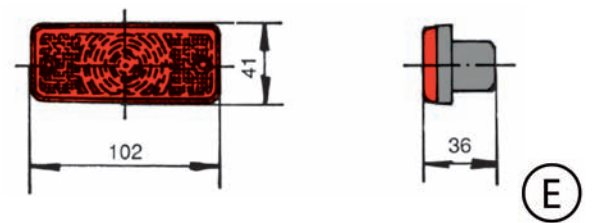

| REF. | Color Colour Farbe Couleur | 12/24V 5W |
|--------|-------------------------------------|-----------|
| 896.00 | ● | ● |
| 897.00 | ○ | ● |
| 886.00 | ● | ● |
| 898.00 | ● | ● |

Luces de Posición Position Lamps

Lichtraum Feux de Position

■ Aplicación / ■ Application / ■ Anwendung / ■ Application

UNIVERSAL



| REF. | Color | Tulipa |
|------|---------|-----------|
| | Colour | Lens |
| | Farbe | Linse |
| | Couleur | Cabochoon |

| | | |
|---------|---|---------|
| 172R.00 | ● | 4590.11 |
| 172I.00 | ○ | 4621.11 |

■ Con Catadióptrico / ■ With Reflector / ■ Mit Rückstrahler / ■ Avec Catadioptré

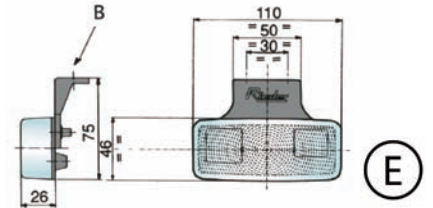

■ Aplicación / ■ Application / ■ Anwendung / ■ Application

UNIVERSAL



| REF. | Color | Tulipa |
|------|---------|-----------|
| | Colour | Lens |
| | Farbe | Linse |
| | Couleur | Cabochoon |

| | | |
|---------|---|---------|
| 173R.00 | ● | 4623.11 |
| 173I.00 | ○ | 4622.11 |

■ Sin Catadióptrico / ■ Without Reflector / ■ Ohne Rückstrahler / ■ Sans Catadioptré

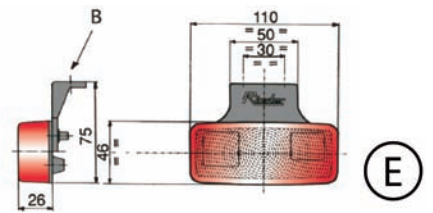

■ Aplicación / ■ Application / ■ Anwendung / ■ Application

UNIVERSAL



| REF. | Color | Tulipa |
|------|---------|-----------|
| | Colour | Lens |
| | Farbe | Linse |
| | Couleur | Cabochoon |

| | | |
|---------|---|---------|
| 170R.00 | ● | 4590.11 |
| 170I.00 | ○ | 4621.11 |

■ Con Catadióptrico / ■ With Reflector / ■ Mit Rückstrahler / ■ Avec Catadioptré

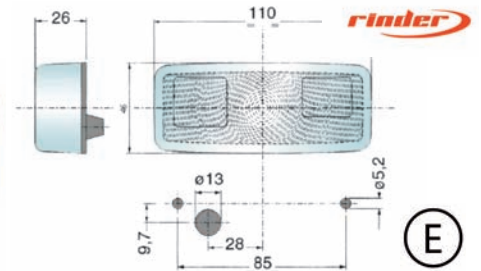

■ Aplicación / ■ Application / ■ Anwendung / ■ Application

UNIVERSAL



| REF. | Color | Tulipa |
|------|---------|-----------|
| | Colour | Lens |
| | Farbe | Linse |
| | Couleur | Cabochoon |

| | | |
|---------|---|---------|
| 171R.00 | ● | 4623.11 |
| 171I.00 | ○ | 4622.11 |
| 171V.00 | ● | 4603.11 |

■ Sin Catadióptrico
■ Without Reflector
■ Ohne Rückstrahler
■ Sans Catadioptré

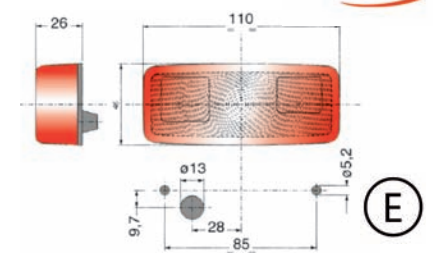

Luces de Posición Position Lamps

Lichtraum Feux de Position

■ Aplicación / ■ Application / ■ Anwendung / ■ Application

UNIVERSAL



| REF. | Color Colour Farbe Couleur | 12/24V 5W | Tulipa Lens Linse Cabocho |
|--------|-------------------------------------|-----------|------------------------------------|
| 893.00 | ● | ● | 1236.11 |
| 894.00 | ○ | ● | 1237.11 |
| 889.00 | ● | ● | 1268.11 |
| 895.00 | ● | ● | 1267.11 |

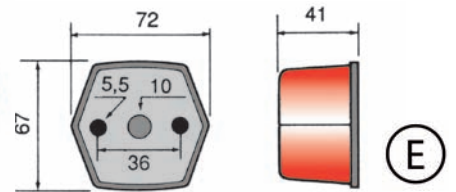

■ Sin Catadióptrico
■ Without Reflector
■ Ohne Rückstrahler
■ Sans Catadioptr

■ Aplicación / ■ Application / ■ Anwendung / ■ Application

UNIVERSAL



| REF. | Color Colour Farbe Couleur | 12/24V 5W | Tulipa Lens Linse Cabocho |
|--------|-------------------------------------|-----------|------------------------------------|
| 870.00 | ● | ● | 4422.11 |
| 871.00 | ○ | ● | 4419.11 |
| 872.00 | ● | ● | 4423.11 |

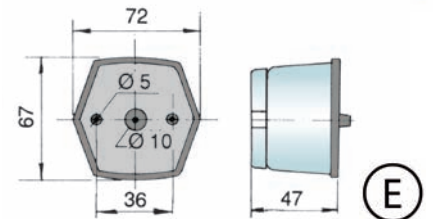

■ Con Catadióptrico
■ With Reflector
■ Mit Rückstrahler
■ Avec Catadioptr

■ Aplicación / ■ Application / ■ Anwendung / ■ Application

UNIVERSAL



| REF. | Color Colour Farbe Couleur | 12/24V 5W | Tulipa Lens Linse Cabocho |
|--------|-------------------------------------|-----------|------------------------------------|
| 899.00 | ○ | ● | 1237.11 |

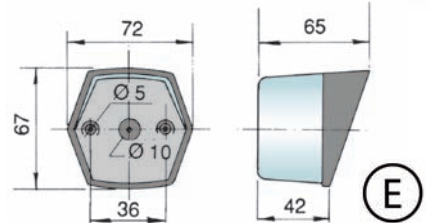

■ Sin Catadióptrico
■ Without Reflector
■ Ohne Rückstrahler
■ Sans Catadioptr

■ Aplicación / ■ Application / ■ Anwendung / ■ Application

UNIVERSAL

| REF. | Color Colour Farbe Couleur | 12/24V 5W | Tulipa Lens Linse Cabocho |
|---------|-------------------------------------|-----------|------------------------------------|
| 869R.00 | ● | ● | 4453.11 |
| 869I.00 | ○ | ● | 4455.11 |
| 869A.00 | ● | ● | 4454.11 |

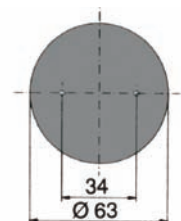

Luces de Posición Position Lamps

Lichtraum Feux de Position

■ Aplicación / ■ Application / ■ Anwendung / ■ Application

UNIVERSAL

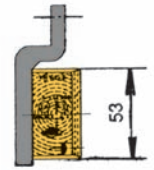
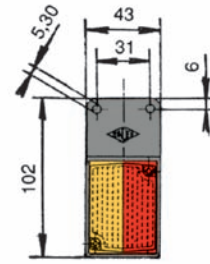

E

| REF. | Color Colour Farbe Couleur | 12/24V 5W | Tulipa Lens Linse Cabocho |
|--------|-------------------------------------|-----------|------------------------------------|
| 846.00 | ● ○ | ● | 1229.11 |
| 846.01 | ● ● | ● | 1173.11 |
| 846.02 | ● | ● | 1228.11 |

■ Aplicación / ■ Application / ■ Anwendung / ■ Application

UNIVERSAL

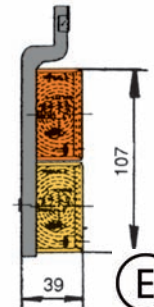
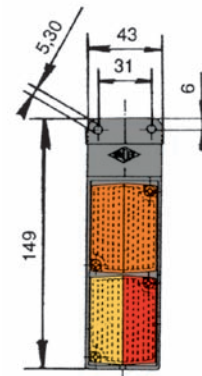

E

| REF. | Color Colour Farbe Couleur | 12/24V 5W | Tulipa Lens Linse Cabocho |
|--------|-------------------------------------|-----------|------------------------------------|
| 847.00 | ● ○ | ● | 1229.11 |
| | ● | ● | 1228.11 |

■ Aplicación / ■ Application / ■ Anwendung / ■ Application

UNIVERSAL

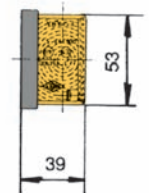
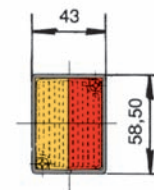
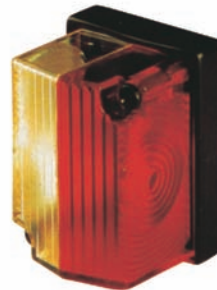

E

| REF. | Color Colour Farbe Couleur | 12/24V 5W | Tulipa Lens Linse Cabocho |
|--------|-------------------------------------|-----------|------------------------------------|
| 848.00 | ● ○ | ● | 1229.11 |
| 849.00 | ● | ● | 1228.11 |
| 853.00 | ● | ● | 1276.11 |

Luces de Posición Position Lamps

Lichtraum Feux de Position

■ Aplicación / ■ Application / ■ Anwendung / ■ Application

UNIVERSAL

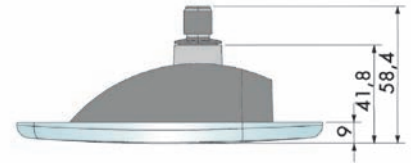
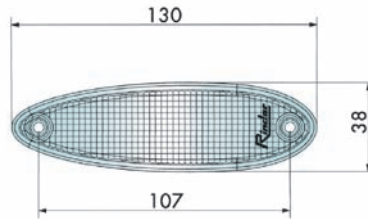
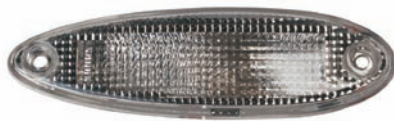

E

| REF. | Color Colour Farbe Couleur | W 5W |
|---------|-------------------------------------|------|
| 9211.00 | ○ | ● |
| 921R.00 | ● | ● |

■ Aplicación / ■ Application / ■ Anwendung / ■ Application

UNIVERSAL

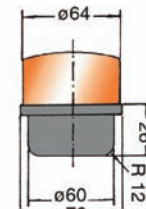

E

| REF. | Color Colour Farbe Couleur | Intermitente Indicator Blinkleuchte Clignotant | Posición Position Standlicht Position | Posición Stop Stop Position Brems-Schlußleuchte Stop position | Tulipa Lens Linse Cabocho |
|----------|-------------------------------------|---|--|--|------------------------------------|
| * 805.02 | ● | ● | | | 1212.11 |
| 805.03 | ● | | ● | | 1209.11 |
| 805.04 | ○ | | ● | | 1213.11 |
| 805.05 | ● | | | ● | 1209.11 |

* ■ Intermitente Posterior / ■ Rear Indicator / ■ Rückserte Blinkleuchte / ■ Clignotant Arrière

■ Aplicación / ■ Application / ■ Anwendung / ■ Application

UNIVERSAL

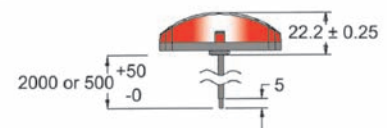
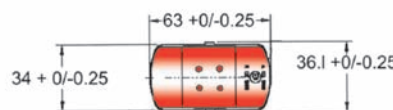

E

| REF. | Color Colour Farbe Couleur | Tensión Voltage Spannung Tension | Polaridad Polarity Polarität Polarité | LED LED LED LED |
|---------|-------------------------------------|---|--|--------------------------|
| 881R.00 | ● | 12/24 V | ● | ● |
| 8811.00 | ○ | 12/24 V | ● | ● |

Luces de Posición Position Lamps

Lichtraum Feux de Position



■ Aplicación / ■ Application / ■ Anwendung / ■ Application

UNIVERSAL

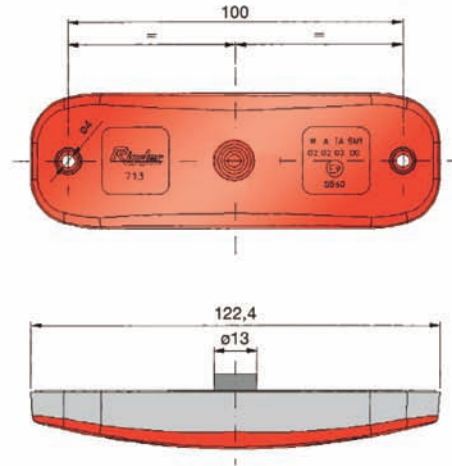

LED

| REF. | Color Colour Farbe Couleur | Tensión Voltage Spannung Tension | L(M) | Cable Cable Kabel Câble | Conector Connector Anschlußsystem Connecteur |
|--------|-------------------------------------|---|------|----------------------------------|---|
| 714.12 | ● | 12V | 0,5 | ○ | |
| 714.24 | ● | 24V | 0,5 | ○ | |
| 713.12 | ○ | 12V | 0,5 | ○ | |
| 713.24 | ○ | 24V | 0,5 | ○ | |
| 714.32 | ● | 12V | 3 | □ | ● |
| 714.44 | ● | 24V | 3 | □ | ● |
| 713.32 | ○ | 12V | 3 | □ | ● |
| 713.44 | ○ | 24V | 3 | □ | ● |

■ Sin Polaridad / ■ Without Polarity / ■ Ohne Polarität / ■ Sans Polarité
 ■ Cable ADR / ■ Cable ADR / ■ Kabel ADR / ■ Câble ADR



Luces de Posición Position Lamps

Lichtraum Feux de Position



■ Aplicación / ■ Application / ■ Anwendung / ■ Application

UNIVERSAL

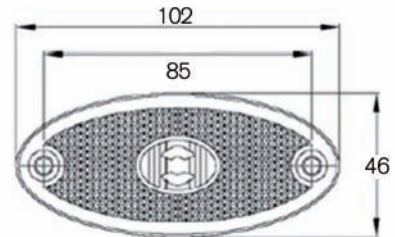

| REF. | Color | Tensión | L(M) | Cable | Conector |
|---------|---------|----------|------|-------|----------------|
| | Colour | Voltage | | Cable | Connector |
| | Farbe | Spannung | | Kabel | Anschlußsystem |
| | Couleur | Tension | | Câble | Connecteur |
| 719R.00 | ● | 12/24V | 0,5 | ○ | |
| 719R.50 | ● | 12/24V | 3 | ▭ | ● |
| 719I.00 | ○ | 12/24V | 0,5 | ○ | |
| 719I.50 | ○ | 12/24V | 3 | ▭ | ● |

(E)

■ Aplicación / ■ Application / ■ Anwendung / ■ Application

UNIVERSAL

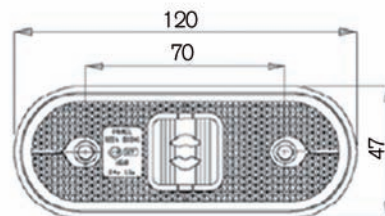

| REF. | Color | Tensión | L(M) | Cable | Conector |
|---------|---------|----------|------|-------|----------------|
| | Colour | Voltage | | Cable | Connector |
| | Farbe | Spannung | | Kabel | Anschlußsystem |
| | Couleur | Tension | | Câble | Connecteur |
| 720R.00 | ● | 12/24V | 0,5 | ○ | |
| 720R.50 | ● | 12/24V | 3 | ▭ | ● |
| 720I.00 | ○ | 12/24V | 0,5 | ○ | |
| 720I.50 | ○ | 12/24V | 3 | ▭ | ● |

Luces de Posición Lateral
Side Marker Lamps
Seitenmarkierungsleuchten
Feux Latéraux de Position



More than 50 years
Showing
your way



Luces de Posición Lateral Side Marker Lamps

Seitenmarkierungsleuchten Feux Latéraux de Position



■ Aplicación / ■ Application / ■ Anwendung / ■ Application

UNIVERSAL

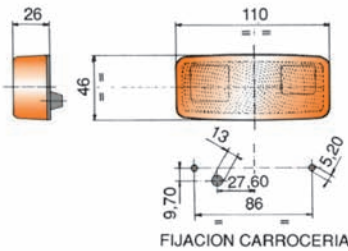

Tipo A
Type A

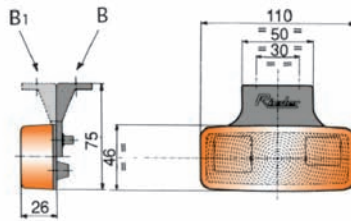

Tipo B-B₁
Type B-B₁

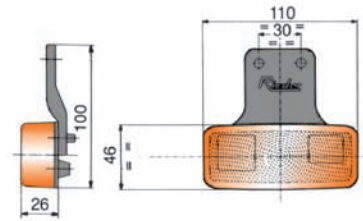

Tipo C
Type C

| REF. | Tipo Type | Catadióptrico Reflector Tipo Type | Pasacables Grommet Scheischlinge Passe Cable | Racor Cable Grand Kabelverschraubung Raccord | 12/24V 5W | Tulipa Lens Linse Cabochon |
|--------|--------------|--|---|---|-----------|-------------------------------------|
| 170.00 | A | ● | ● | | ● | 4500.11 |
| 170.50 | A | ● | | ● | ● | 4500.11 |
| 171.00 | A | | ● | | ● | 4501.11 |
| 171.50 | A | | | ● | ● | 4501.11 |
| 172.00 | B | ● | ● | | ● | 4500.11 |
| 172.10 | B1 | ● | ● | | ● | 4500.11 |
| 172.50 | B | ● | | ● | ● | 4500.11 |
| 172.60 | B1 | ● | | ● | ● | 4500.11 |
| 173.00 | B | | ● | | ● | 4501.11 |
| 173.10 | B1 | | ● | | ● | 4501.11 |
| 173.50 | B | | | ● | ● | 4501.11 |
| 173.60 | B1 | | | ● | ● | 4501.11 |
| 174.00 | C | ● | ● | | ● | 4500.11 |
| 174.50 | C | ● | | ● | ● | 4500.11 |
| 175.00 | C | | ● | | ● | 4501.11 |
| 175.50 | C | | | ● | ● | 4501.11 |

E

Luces de Posición Lateral Side Marker Lamps

Seitenmarkierungsleuchten Feux Latéraux de Position

■ Aplicación / ■ Application / ■ Anwendung / ■ Application

UNIVERSAL



LED

REF. Tensión
Voltage
Spannung
Tension

| | |
|--------|-----|
| 715.52 | 12V |
| 715.54 | 24V |

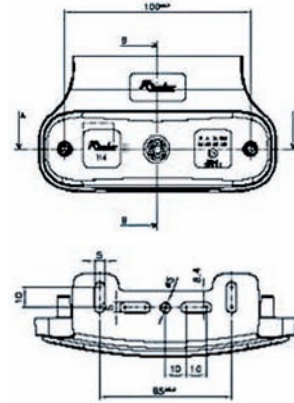

(E)

■ Sin Polaridad / ■ Without Polarity / ■ Ohne Polarität / ■ Sans Polarité

■ Aplicación / ■ Application / ■ Anwendung / ■ Application

UNIVERSAL



LED

REF. Tensión
Voltage
Spannung
Tension

| | |
|--------|-----|
| 715.12 | 12V |
| 715.24 | 24V |

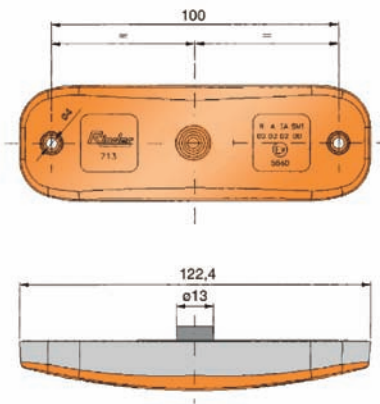

(E)

■ Sin Polaridad / ■ Without Polarity / ■ Ohne Polarität / ■ Sans Polarité

■ Aplicación / ■ Application / ■ Anwendung / ■ Application

UNIVERSAL



LED

REF. Tensión
Voltage
Spannung
Tension

| | | |
|--------|---|-----|
| 178.50 | ● | 24V |
| 178.51 | ● | 24V |

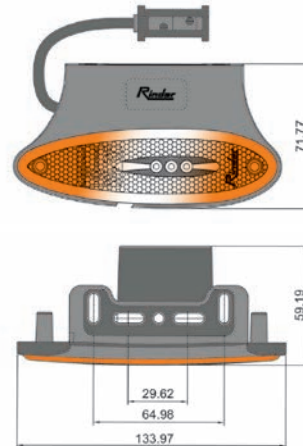

(E)

Luces de Posición Lateral Side Marker Lamps

Seitenmarkierungsleuchten Feux Latéraux de Position

■ Aplicación / ■ Application / ■ Anwendung / ■ Application

UNIVERSAL



| REF. | | | Tensión Voltage Spannung Tension | W 5W |
|--------|---|---|---|------|
| 179.50 | ● | | 24V | ● |
| 179.51 | | ● | 24V | ● |
| 179.60 | ● | | 12V | ● |
| 179.61 | | ● | 12V | ● |



(E)

■ Aplicación / ■ Application / ■ Anwendung / ■ Application

UNIVERSAL



LED

| REF. | Tensión Voltage Spannung Tension | LED |
|--------|---|-----|
| 178.00 | 24V | ● |

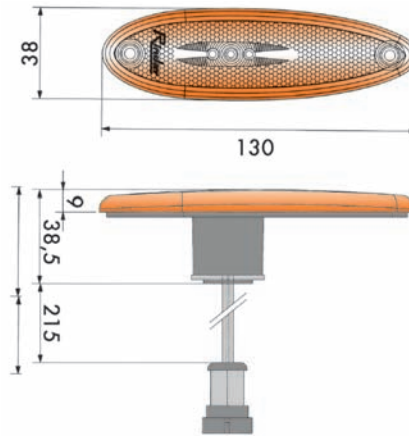

■ Aplicación / ■ Application / ■ Anwendung / ■ Application

UNIVERSAL



| REF. | Tensión Voltage Spannung Tension | W 5W |
|--------|---|------|
| 179.00 | 24V | ● |

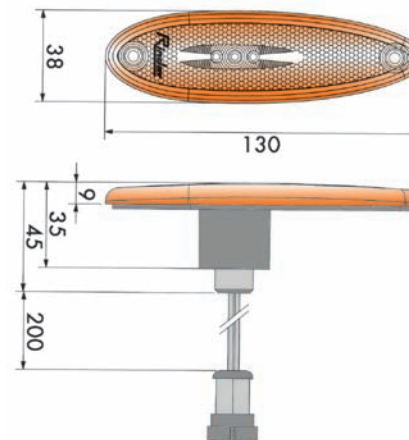

Luces de Posición Lateral Side Marker Lamps

Seitenmarkierungsleuchten Feux Latéraux de Position

■ Aplicación / ■ Application / ■ Anwendung / ■ Application

UNIVERSAL



(A)

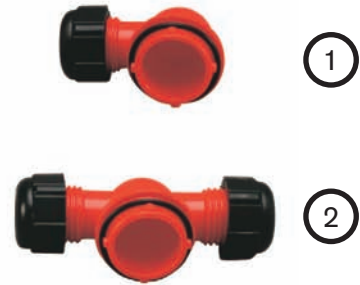
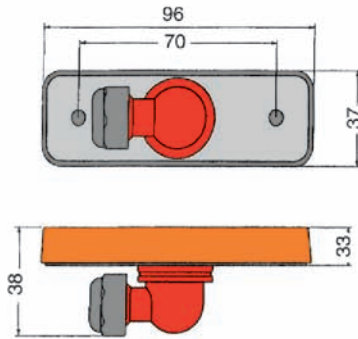

LED

| REF. | Tipo Type Art Type | Tensión Voltage Spannung Tension |
|--------|-----------------------------|---|
| 168.00 | A + 1 | 24V |
| 168.50 | A + 2 | 24V |

(E)

■ Aplicación / ■ Application / ■ Anwendung / ■ Application

UNIVERSAL



(A)

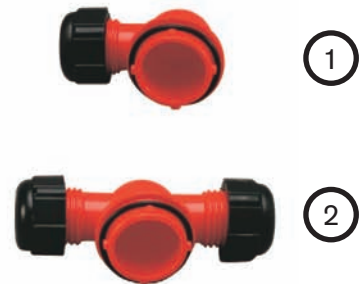
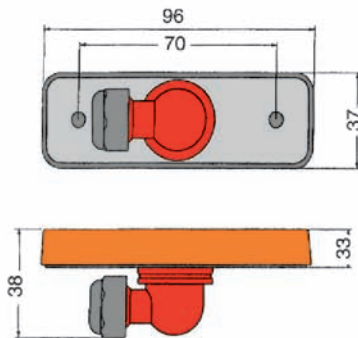

LED

| REF. | Tipo Type Art Type | Tensión Voltage Spannung Tension |
|--------|-----------------------------|---|
| 169.00 | A + 1 | 24V |
| 169.50 | A + 2 | 24V |

(E)

Luces de Posición Lateral Side Marker Lamps

Seitenmarkierungsleuchten Feux Latéraux de Position

■ Aplicación / ■ Application / ■ Anwendung / ■ Application

UNIVERSAL



| REF. | Tensión Voltage Spannung Tension | L |
|---------|---|-----|
| 719A.00 | 12/24V | 0,5 |
| 719A.20 | 12/24V | 2 |

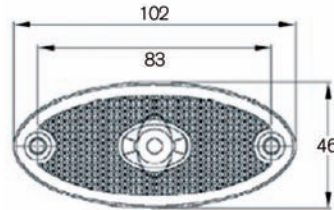

E



■ Aplicación / ■ Application / ■ Anwendung / ■ Application

UNIVERSAL



| REF. | | Tensión Voltage Spannung Tension | L(M) |
|---------|---|---|------|
| 719A.30 | A | 12/24V | 0,5 |
| 719A.50 | A | 12/24V | 2 |
| 719A.70 | B | 12/24V | 0,5 |
| 719A.90 | B | 12/24V | 2 |

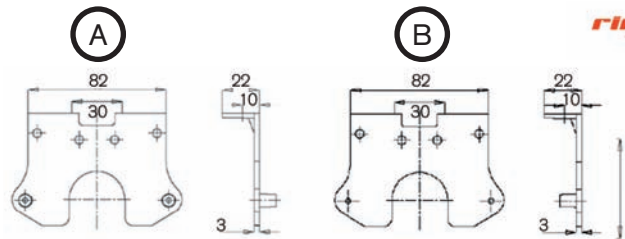

E



■ Aplicación / ■ Application / ■ Anwendung / ■ Application

UNIVERSAL



| REF. | Tensión Voltage Spannung Tension | L |
|---------|---|-----|
| 720A.00 | 12/24V | 0,5 |
| 720A.20 | 12/24V | 2 |

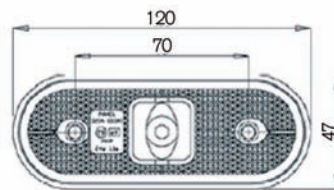

E



■ Aplicación / ■ Application / ■ Anwendung / ■ Application

UNIVERSAL



| REF. | | Tensión Voltage Spannung Tension | L(M) |
|---------|---|---|------|
| 720A.30 | A | 12/24V | 0,5 |
| 720A.50 | A | 12/24V | 2 |
| 720A.70 | B | 12/24V | 0,5 |
| 720A.90 | B | 12/24V | 2 |

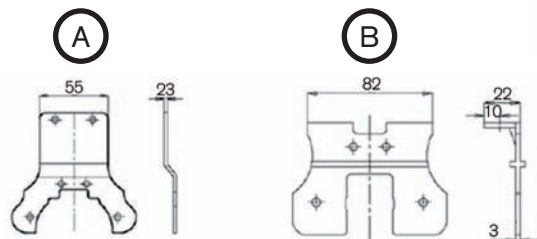

E



Intermitentes Laterales
Side Indicators
Seiteblinkleuchte
Clignotants Latéraux

More than 50 years
Showing
your way

Intermitentes Laterales Side Indicators

Seiteblinkleuchte Clignotants Latéraux

■ Aplicación / ■ Application / ■ Anwendung / ■ Application



926-I



926-A

| REF. | Color Colour Farbe Couleur | 21 W | PY 21 W | Tulipa Lens Linse Cabochon |
|----------|-------------------------------------|------|---------|-------------------------------------|
| 926-I.00 | ○ | | ● | 4723.11 |
| 926-A.00 | ● | ● | | 4738.11 |

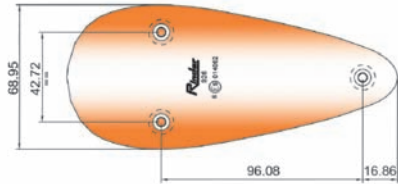
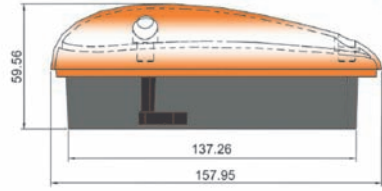

(E)

- Categoría 6^a
- 6th Category
- 6. Kategorie
- 6 ième Catégorie

■ Aplicación / ■ Application / ■ Anwendung / ■ Application



LED

| REF. | Color Colour Farbe Couleur | Tensión Voltage Spannung Tension |
|--------|-------------------------------------|---|
| 989.12 | ● | 12V |
| 989.24 | ● | 24V |

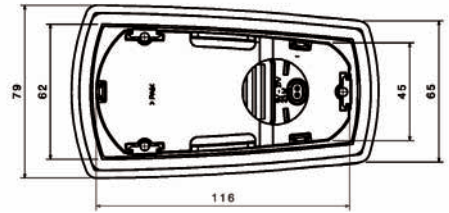
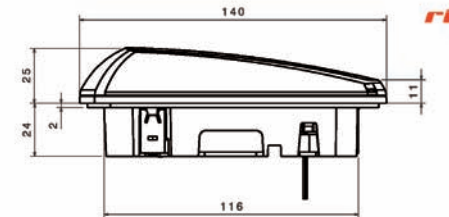

(E)

- Categoría 6^a
- 6th Category
- 6. Kategorie
- 6 ième Catégorie

■ Aplicación / ■ Application / ■ Anwendung / ■ Application

UNIVERSAL

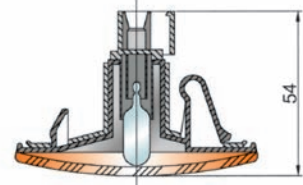
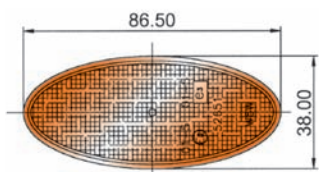

(E)

| REF. | Bus | Car | W 5W |
|--------|-----|-----|------|
| 887.00 | ● | ● | 24V |
| 888.00 | ● | ● | 12V |

- Categoría 6^a
- 6th Category
- 6. Kategorie
- 6 ième Catégorie

Luces de Freno
Brake Lights
Zusatzbremsleuchte
Feux de Stop

Perfect **lights**
to perfect breaks

Luces de Freno | Zusatzbremsleuchte Brake Lights | Feux de Stop

■ Aplicación / ■ Application / ■ Anwendung / ■ Application



UNIVERSAL

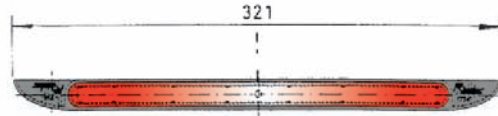

(E)

| REF. | Tensión Voltage Spannung Tension |
|---------|---|
| 740R.12 | 12V |
| 740R.24 | 24V |
| 740I.12 | 12V |
| 740I.24 | 24V |



■ Aplicación / ■ Application / ■ Anwendung / ■ Application



UNIVERSAL

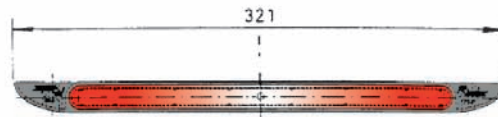
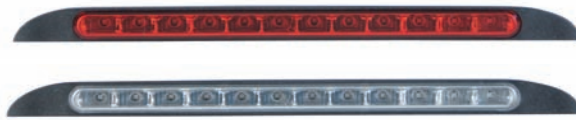

(E)

| REF. | Tensión Voltage Spannung Tension |
|---------|---|
| 743R.12 | 12V |
| 743R.24 | 24V |
| 743I.12 | 12V |
| 743I.24 | 24V |



■ Aplicación / ■ Application / ■ Anwendung / ■ Application



UNIVERSAL

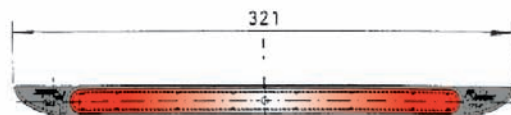

(E)

| REF. | Tensión Voltage Spannung Tension |
|---------|---|
| 744R.12 | 12V |
| 744R.24 | 24V |
| 744I.12 | 12V |
| 744I.24 | 24V |



■ Guía Óptica / ■ Optical Guide / ■ Optische Leitfaden / ■ Guide Optique

Luces de Freno | Zusatzbremsleuchte Brake Lights | Feux de Stop

■ Aplicación / ■ Application / ■ Anwendung / ■ Application



UNIVERSAL

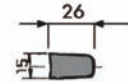
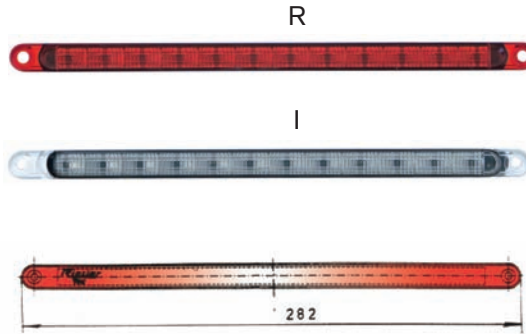

| REF. | Tensión Voltage Spannung Tension |
|---------|---|
| 716R.12 | 12V |
| 716R.24 | 24V |
| 716I.12 | 12V |
| 716I.24 | 24V |

LED

■ Aplicación / ■ Application / ■ Anwendung / ■ Application



UNIVERSAL

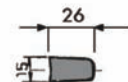
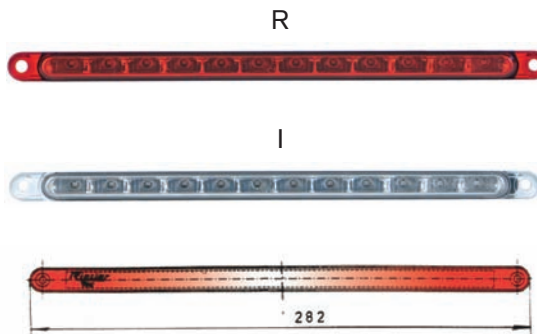

| REF. | Tensión Voltage Spannung Tension |
|---------|---|
| 717R.12 | 12V |
| 717R.24 | 24V |
| 717I.12 | 12V |
| 717I.24 | 24V |

LED

■ Aplicación / ■ Application / ■ Anwendung / ■ Application



UNIVERSAL

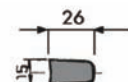
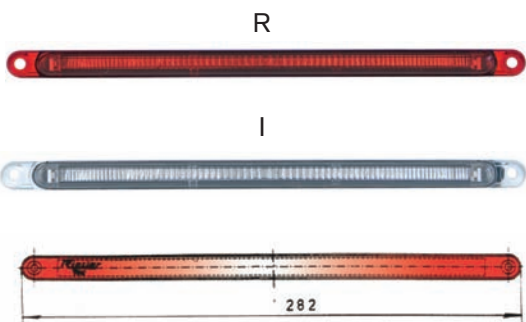

| REF. | Tensión Voltage Spannung Tension |
|---------|---|
| 718R.12 | 12V |
| 718R.24 | 24V |
| 718I.12 | 12V |
| 718I.24 | 24V |

LED

■ Guía Óptica / ■ Optical Guide / ■ Optische Leitfaden / ■ Guide Optique

Luces de Freno | Zusatzbremsleuchte Brake Lights | Feux de Stop

■ Aplicación / ■ Application / ■ Anwendung / ■ Application

UNIVERSAL



| REF. | Tensión Voltage Spannung Tension |
|------|---|
|------|---|

717R.07 12V

717R.08 24V

717I.07 12V

717I.08 24V

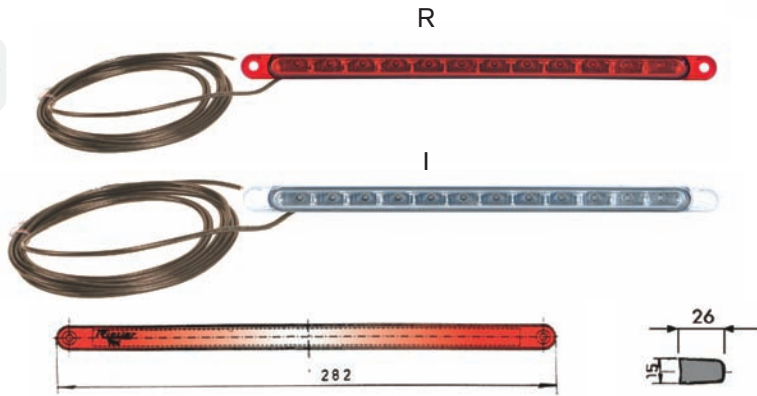

LED

■ 4 m. Cable ADR / ■ 4 m Adr Cable / ■ ADR Kabel 4m Lang / ■ 4m Câble Adr



(E)

■ Aplicación / ■ Application / ■ Anwendung / ■ Application

UNIVERSAL



| REF. | Tensión Voltage Spannung Tension |
|------|---|
|------|---|

743R.07 12V

743R.08 24V

744I.07 12V

744I.08 24V

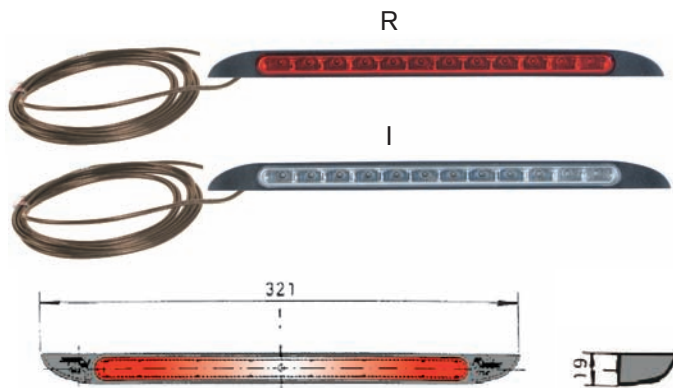

LED

■ 4 m. Cable ADR / ■ 4 m Adr Cable / ■ ADR Kabel 4m Lang / ■ 4m Câble Adr



(E)

A long-exposure photograph of a car at night, showing light trails from its headlights and taillights. The license plate area is brightly lit, creating a prominent light trail. The background is dark with horizontal streaks of light from other vehicles or streetlights.

Luces de Matrícula
Number Plate Lights
Kennzeichenbeleuchtung
Eclaireur de Plaques

This is
your light

Luces de Matrícula Number Plate Lights

Kennzeichenbeleuchtung ECLAIREUR de PLAQUES

■ Aplicación / ■ Application / ■ Anwendung / ■ Application

UNIVERSAL

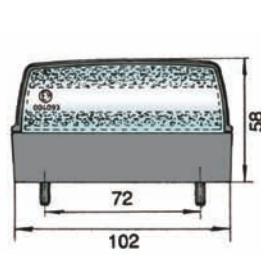

E

REF. 12/24V 5W

963.00



■ Aplicación / ■ Application / ■ Anwendung / ■ Application

UNIVERSAL

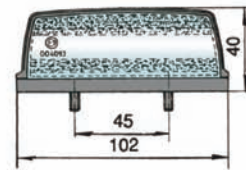

E

REF. 12/24V 5W

965.00



■ Aplicación / ■ Application / ■ Anwendung / ■ Application

UNIVERSAL

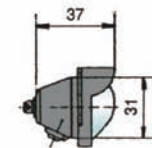
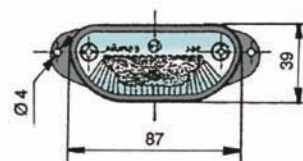

E

REF. 12/24V 5W

964.00



■ Aplicación / ■ Application / ■ Anwendung / ■ Application

UNIVERSAL

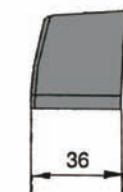
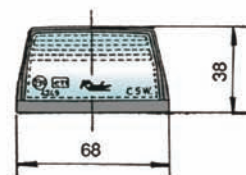

E

REF. 12/24V 5W

969.00



Luces de Matrícula Number Plate Lights

Kennzeichenbeleuchtung Eclaireur de Plaques

■ Aplicación / ■ Application / ■ Anwendung / ■ Application

UNIVERSAL



REF. 12/24V 5W

769.00



■ Aplicación / ■ Application / ■ Anwendung / ■ Application

UNIVERSAL



REF. 12/24V 5W L(M)

769.50

0,5



■ Aplicación / ■ Application / ■ Anwendung / ■ Application

UNIVERSAL



REF. 12/24V 5W

769R.00



■ Aplicación / ■ Application / ■ Anwendung / ■ Application

UNIVERSAL



REF. 12/24V 5W L(M)

769R.50

0,5



Luces de Matrícula Number Plate Lights

Kennzeichenbeleuchtung Eclaireur de Plaques

■ Aplicación / ■ Application / ■ Anwendung / ■ Application

UNIVERSAL

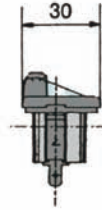
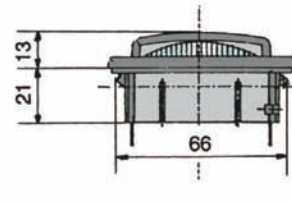

E

REF. 12V 5W

970.00



■ Aplicación / ■ Application / ■ Anwendung / ■ Application

UNIVERSAL

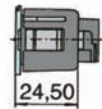
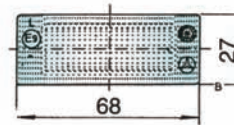
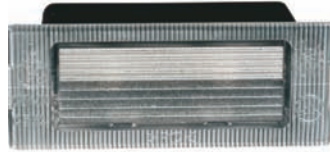

E

REF. 12V 5W

971.00



■ Aplicación / ■ Application / ■ Anwendung / ■ Application

UNIVERSAL

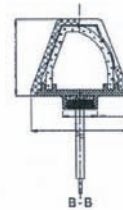

E

REF. Tensión
Voltage
Spannung
Tension

767.12

12V

767.24

24V



Pilotos Marcha Atrás
Reversing Lights
Rückfahrleuchte
Feux de Recul

lighting
you

you



Pilotos Marcha Atrás | Rückfahrleuchte Reversing Lights | Feux de Recul

■ Aplicación / ■ Application / ■ Anwendung / ■ Application

UNIVERSAL

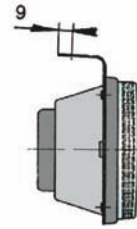
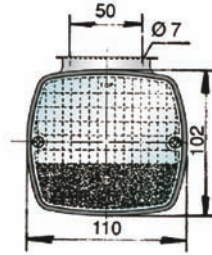

(E)

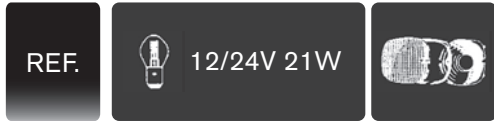

588.00



1221.11

■ Aplicación / ■ Application / ■ Anwendung / ■ Application

UNIVERSAL

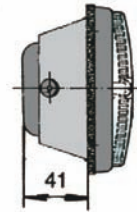
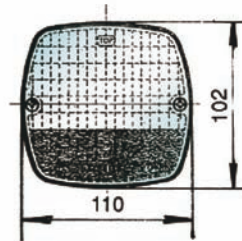

(E)

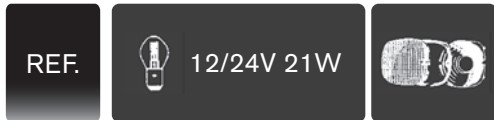

589.00



1221.11

■ Aplicación / ■ Application / ■ Anwendung / ■ Application

UNIVERSAL

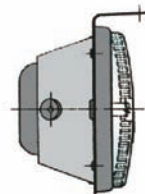
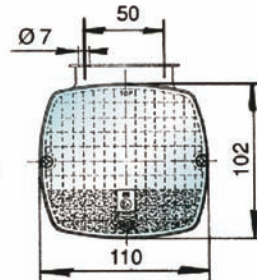

(E)

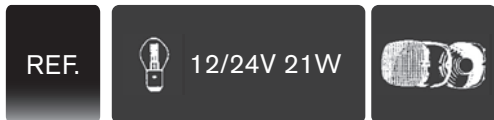

590.00



1221.11

■ Aplicación / ■ Application / ■ Anwendung / ■ Application

UNIVERSAL

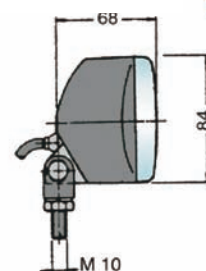
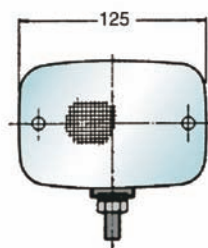

(E)



587.00



Pilotos Antiniebla
Fog Lamps
Nebelschlußleuchte
Feux de Brouillard



light
through the fog



Pilotos Antiniebla | Nebelschlußleuchte Fog Lamps | Feux de Brouillard

■ Aplicación / ■ Application / ■ Anwendung / ■ Application

UNIVERSAL

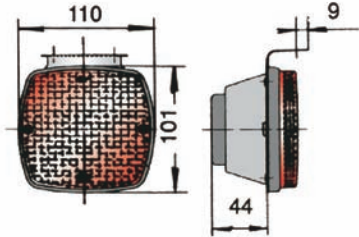

(E)

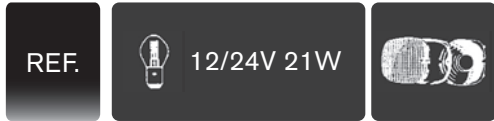

580.00



1231.11

■ Aplicación / ■ Application / ■ Anwendung / ■ Application

UNIVERSAL

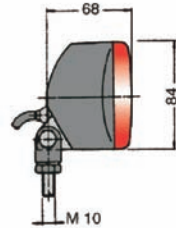
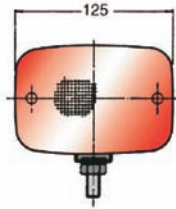

(E)



581.00



■ Aplicación / ■ Application / ■ Anwendung / ■ Application

UNIVERSAL

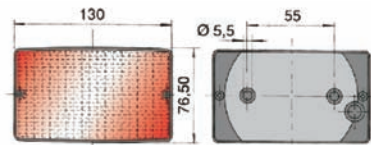

(E)



578.00



■ Aplicación / ■ Application / ■ Anwendung / ■ Application

UNIVERSAL

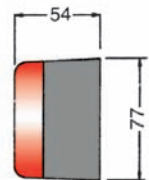
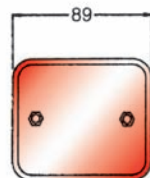

(E)



582.00



Luces Interiores
Interior Lights
Innenleuchten
Eclairage Interieur



The **light** what you need
when you need

Luces Interiores Interior Lights

Innenleuchten Eclairage Interieur

■ Aplicación / ■ Application / ■ Anwendung / ■ Application

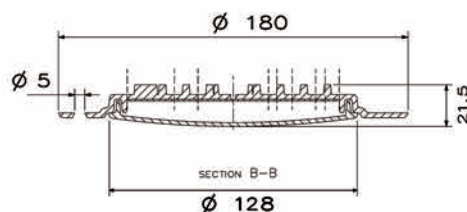
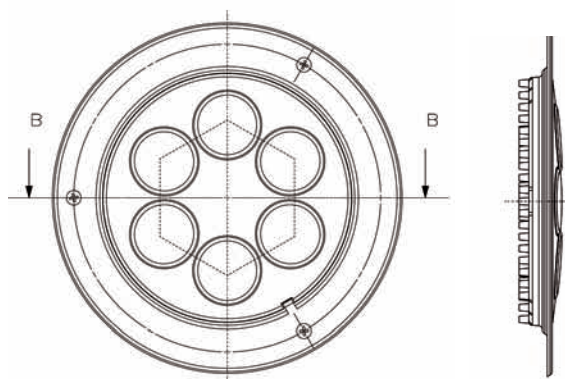
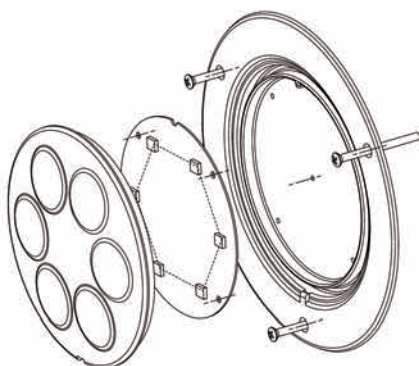
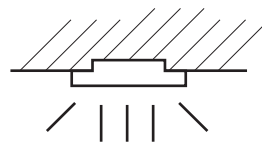

| REF. | Tensión Voltage Spannung Tension | LED | Flujo Luminoso Luminous Flux Flussleuchte Flux Lumineux | Lux 1M |
|--------|---|-----|--|---------|
| 567.12 | 12V | 3 | 200 lm | 82 Lux |
| 567.24 | 24V | 3 | 200 lm | 82 Lux |
| 567.62 | 12V | 6 | 400 lm | 140 Lux |
| 567.74 | 24V | 6 | 400 lm | 140 Lux |

Luces Interiores Interior Lights

Innenleuchten Eclairage Interieur

■ Aplicación / ■ Application / ■ Anwendung / ■ Application

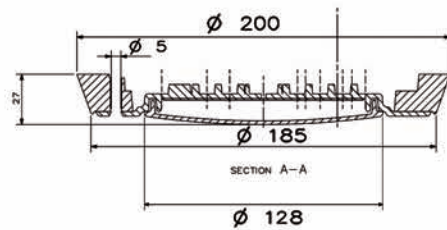
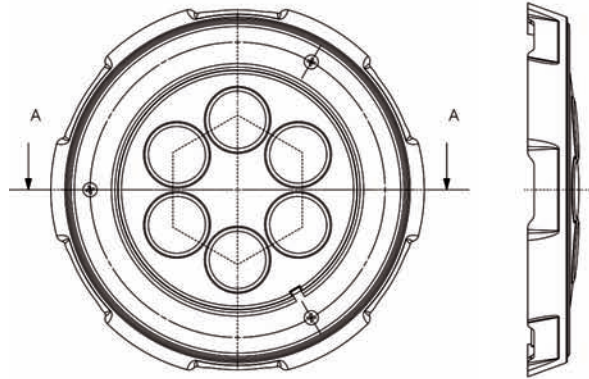
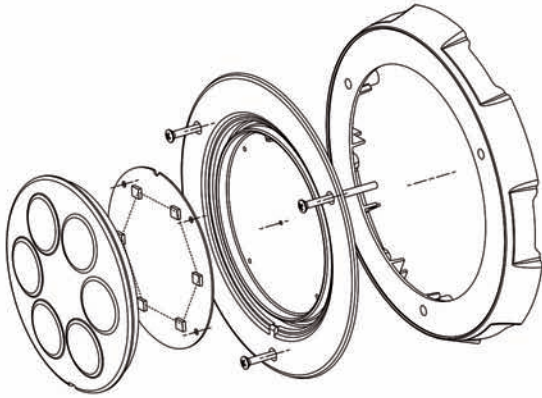
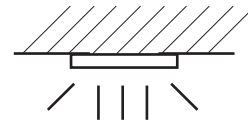

| REF. | Tensión Voltage Spannung Tension | LED | Flujo Luminoso Luminous Flux Flussleuchte Flux Lumineux | Lux 1M |
|--------|---|-----|--|---------|
| 568.12 | 12V | 3 | 200 lm | 82 Lux |
| 568.24 | 24V | 3 | 200 lm | 82 Lux |
| 568.62 | 12V | 6 | 400 lm | 140 Lux |
| 568.74 | 24V | 6 | 400 lm | 140 Lux |

Luces Interiores Interior Lights

Innenleuchten Eclairage Interieur

■ Aplicación / ■ Application / ■ Anwendung / ■ Application

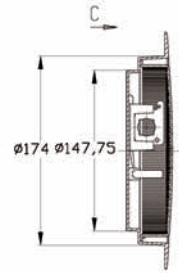
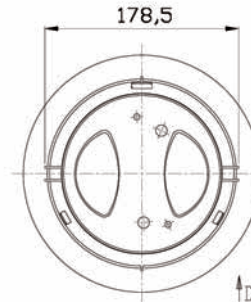
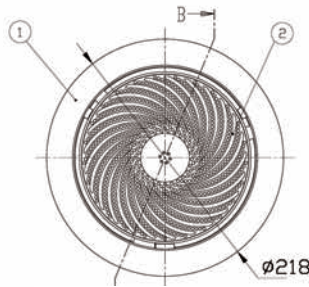
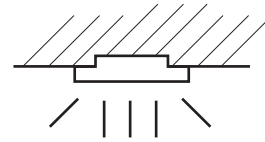

REF. 12/24 V 21W
569.00

■ Aplicación / ■ Application / ■ Anwendung / ■ Application

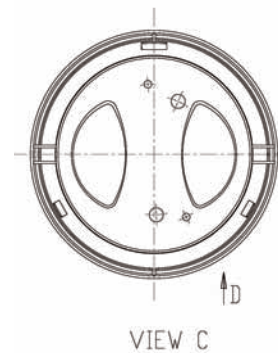
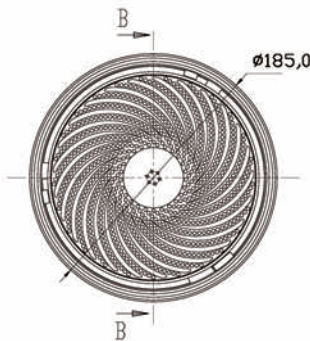
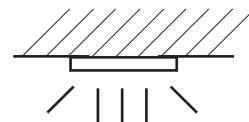

REF. 12/24 V 21W
570.00

Catadióptricos + Placas
Reflectors + Plates
Warntafeln und Rückstrahler
Catadioptré + Plaques



Here
is your "light"



Catadióptricos + Placas Reflectors + Plates

Warntafeln und Rückstrahler Catadioptré + Plaques



■ Aplicación / ■ Application / ■ Anwendung / ■ Application

UNIVERSAL



747R.00
 ■ Adhesivo
 ■ Adhesive
 ■ Selbstklebefolie
 ■ Adhésit



747A.00
 ■ Adhesivo
 ■ Adhesive
 ■ Selbstklebefolie
 ■ Adhésit



747I.00
 ■ Adhesivo
 ■ Adhesive
 ■ Selbstklebefolie
 ■ Adhésit

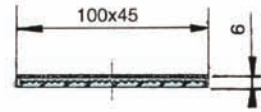

765R.00



765A.00



765I.00

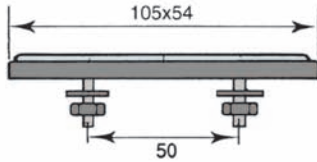

766R.00



766A.00



766I.00

764R.00

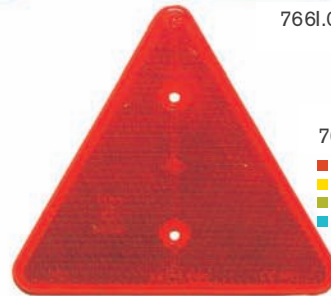
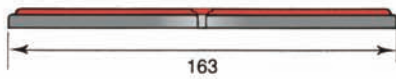
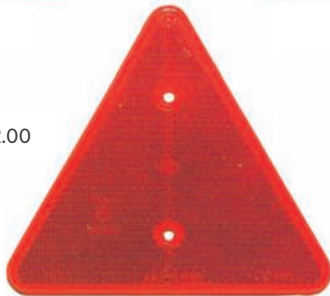

764R.27
 ■ Adhesivo
 ■ Adhesive
 ■ Selbstklebefolie
 ■ Adhésit

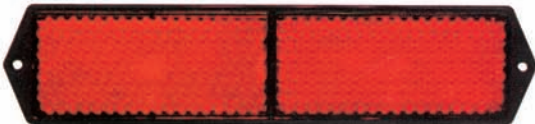
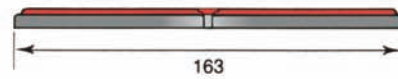

790R.00



790A.00



790I.00

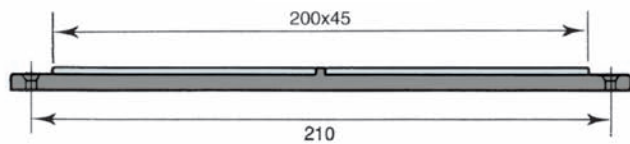

(E)

Catadióptricos + Placas Reflectors + Plates

Warntafeln und Rückstrahler Catadioptre + Plaques



■ Aplicación / ■ Application / ■ Anwendung / ■ Application

UNIVERSAL



755R.00



755A.00

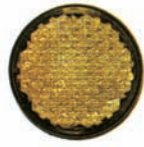

755I.00

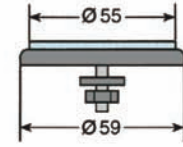

751R.00



751A.00



751I.00

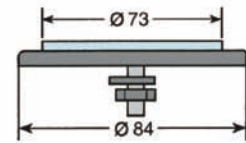

752R.00



752A.00



752I.00

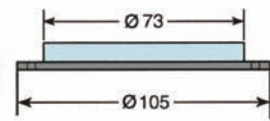

745R.00

- Adhesivo
- Adhesive
- Selbstklebefolie
- Adhésit



745A.00

- Adhesivo
- Adhesive
- Selbstklebefolie
- Adhésit

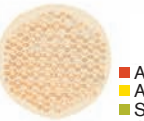

745I.00

- Adhesivo
- Adhesive
- Selbstklebefolie
- Adhésit

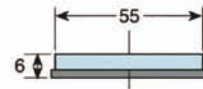

746R.00



746A.00



746I.00

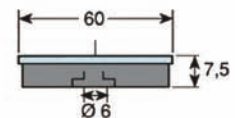

704R.00

- Adhesivo
- Adhesive
- Selbstklebefolie
- Adhésit



704A.00

- Adhesivo
- Adhesive
- Selbstklebefolie
- Adhésit



704I.00

- Adhesivo
- Adhesive
- Selbstklebefolie
- Adhésit

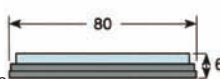

E

Catadióptricos + Placas Reflectors + Plates

Warntafeln und Rückstrahler Catadioptré + Plaques



■ Aplicación / ■ Application / ■ Anwendung / ■ Application

UNIVERSAL



700R.00



700A.00



700I.00

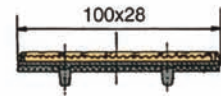

701R.00

- Adhesivo
- Adhesive
- Selbstklebefolie
- Adhésit



701A.00

- Adhesivo
- Adhesive
- Selbstklebefolie
- Adhésit



701I.00

- Adhesivo
- Adhesive
- Selbstklebefolie
- Adhésit

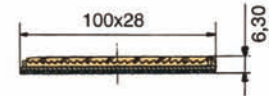

702R.00



702A.00



702I.00

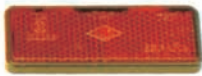
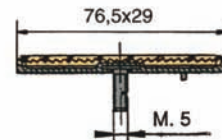

703R.00

- Adhesivo
- Adhesive
- Selbstklebefolie
- Adhésit



703A.00

- Adhesivo
- Adhesive
- Selbstklebefolie
- Adhésit



703I.00

- Adhesivo
- Adhesive
- Selbstklebefolie
- Adhésit

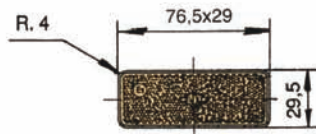

705R.00

- Adhesivo
- Adhesive
- Selbstklebefolie
- Adhésit



705A.00

- Adhesivo
- Adhesive
- Selbstklebefolie
- Adhésit



705I.00

- Adhesivo
- Adhesive
- Selbstklebefolie
- Adhésit



768R.00



768A.00



768I.00

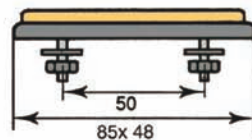

E

Catadióptricos + Placas Reflectors + Plates

Warntafeln und Rückstrahler Catadioptre + Plaques

■ Aplicación / ■ Application / ■ Anwendung / ■ Application

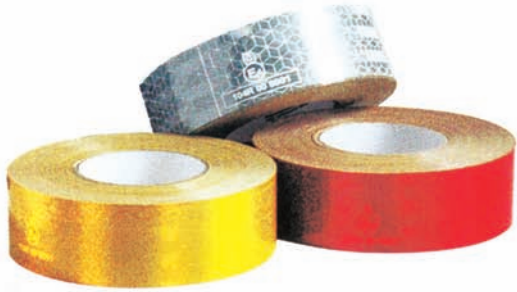

712A.00



712R.00



712I.00

| REF. | Color Colour Farbe Couleur | L(M) |
|---------|-------------------------------------|------|
| 712A.00 | ● | 50 |
| 712R.00 | ● | 50 |
| 712I.00 | ○ | 50 |



■ Aplicación / ■ Application / ■ Anwendung / ■ Application



| REF. | Estuche, 1 ud. Case, 1 ud. Gehäuse, 1 ud. Coffret, 1 ud. | Estuche, 2 uds. Case, 2 uds. Gehäuse, 2 uds. Coffret, 2 uds. |
|---------|---|---|
| 710R.00 | | ● |
| 711R.00 | ● | |



Catadióptricos + Placas | Warntafeln und Rückstrahler Reflectors + Plates | Catadioptré + Plaques

■ Aplicación / ■ Application / ■ Anwendung / ■ Application





1.132 mm

197 mm

REF. ■ Homologado
■ Approved
■ Zugelassen
■ Homologué

5700.00 ECE. 70-00
5700.50 ECE. 70-01

■ Aluminio
■ Aluminium
■ Aluminium
■ Aluminium

■ Aplicación / ■ Application / ■ Anwendung / ■ Application





566 mm

197 mm

REF. ■ Homologado
■ Approved
■ Zugelassen
■ Homologué

5701.00 ECE. 70-00
5701.50 ECE. 70-01

■ Aluminio
■ Aluminium
■ Aluminium
■ Aluminium

■ Aplicación / ■ Application / ■ Anwendung / ■ Application





1.132 mm

132 mm

REF. ■ Aluminio
■ Aluminium
■ Aluminium
■ Aluminium

5715.00

■ Aplicación / ■ Application / ■ Anwendung / ■ Application





566 mm

132 mm

REF. ■ Aluminio
■ Aluminium
■ Aluminium
■ Aluminium

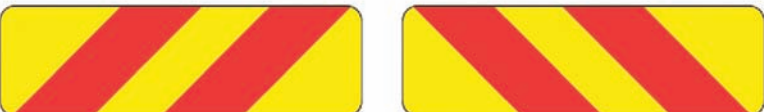
5716.00

Catadióptricos + Placas Reflectors + Plates

Warntafeln und Rückstrahler Catadioptre + Plaques

■ Aplicación / ■ Application / ■ Anwendung / ■ Application

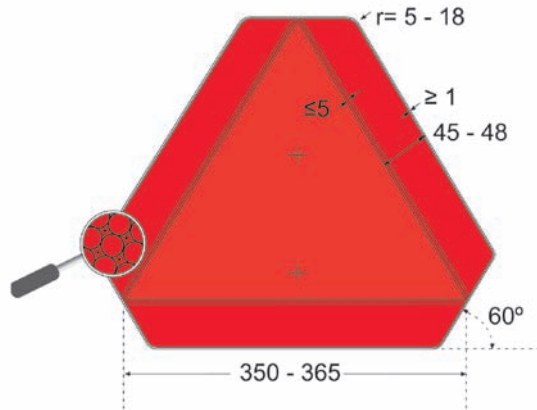

(E)

REF.

5702.00

- Aluminio
- Aluminium
- Aluminium
- Aluminium
- Placa Vehículo Lento
- Slow Moving Vehicle Plate
- SMV Schild
- Plaque Véhicule Lent

■ Aplicación / ■ Application / ■ Anwendung / ■ Application

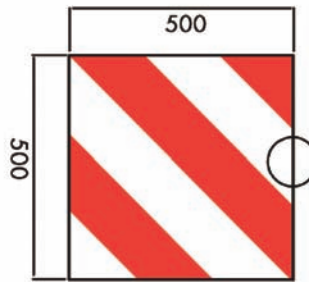

??

(E)

REF.

5703.00

- Aluminio
- Aluminium
- Aluminium
- Aluminium
- Panel para cargas que sobresalen
- Plate for oversize burdens
- Warntafelsatz
- Signalisation Hors Gabarit

■ Aplicación / ■ Application / ■ Anwendung / ■ Application

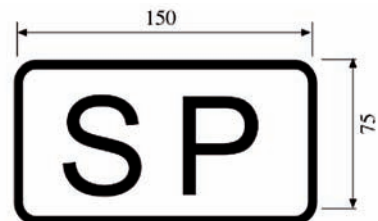
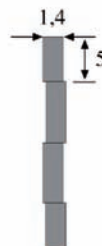
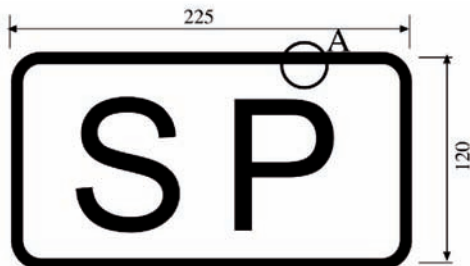

??

(E)

REF.

5706.00

5707.00

- Aluminio
- Aluminium
- Aluminium
- Aluminium

Catadióptricos + Placas Reflectors + Plates

Warntafeln und Rückstrahler Catadioptré + Plaques

■ Aplicación / ■ Application / ■ Anwendung / ■ Application



REF: 5708.00



REF: 5709.00



REF: 5712.00



REF: 5710.00



REF: 5714.00



REF: 5711.00

- Portaplacas Universal: Placas ADR / Placas TIR
- Universal Plate Holders: ADR Plates / TIR Plates
- Warntafelhalter für ADR Tafeln und TIR Tafeln
- Porte-Plaques Universel: Plaques ADR / Plaques TIR



Bocinas + Retroalarmas
Horns + Back-up Alarms
Hupe + Rückfahrwarner
Avertisseur et Alarme de Recul

The **safest**
sound

Bocinas + Retroalarmas Horns + Back-up Alarms

Hupe + Rückfahrwarner Avertisseur et Alarme de Recul

■ Aplicación / ■ Application / ■ Anwendung / ■ Application

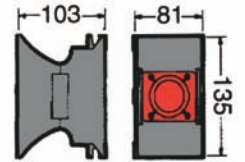
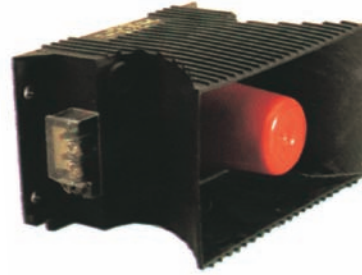

| REF. | Tensión Voltage Spannung Tension | Db | Consumo Consumption Verbrauch Consommation |
|------|---|----------|---|
| 5.00 | 10 - 100 | 88 - 110 | 480mA-50mA |

■ Sonido Autoajustable / ■ Self-adjusting Sound / ■ Selbststellbarer Ton / ■ Son Autorégulé

■ Aplicación / ■ Application / ■ Anwendung / ■ Application

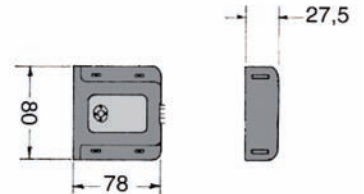

| REF. | Tensión Voltage Spannung Tension | Db | Consumo Consumption Verbrauch Consommation |
|------|---|---------|---|
| 7.00 | 10 - 100 | 85 - 95 | 6mA - 10mA |

■ Aplicación / ■ Application / ■ Anwendung / ■ Application

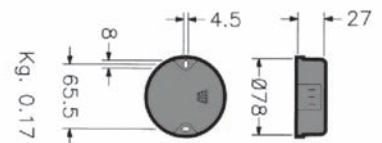

| REF. | Tensión Voltage Spannung Tension | Db | Consumo Consumption Verbrauch Consommation |
|-------|---|---------|---|
| 43.00 | 10 - 100 | 85 - 95 | 6mA - 10mA |

■ Aplicación / ■ Application / ■ Anwendung / ■ Application



| REF. | Tensión Voltage Spannung Tension | Db | Consumo Consumption Verbrauch Consommation | Tono Rápido Fast Pulse Schneller Ton Vibration Rapide | Tono Lento Slow Pulse Langsamer Ton Vibration Lente |
|---------|---|----|---|--|--|
| 5915.00 | 12 - 48V | 80 | 0,1 | ● | |
| 5916.00 | 12 - 48V | 80 | 0,1 | | ● |

Bocinas + Retroalarmas Horns + Back-up Alarms

Hupe + Rückfahrwarner Avertisseur et Alarme de Recul

■ Aplicación / ■ Application / ■ Anwendung / ■ Application



| REF. | Tensión Voltage Spannung Tension | Db | Consumo Consumption Verbrauch Consommation |
|------|---|----|---|
|------|---|----|---|

| | | | |
|-----------|----------|----------|-----|
| * 5900.00 | 12 - 24V | 82 - 102 | 0,4 |
| * 5901.00 | 12 - 48V | 77 - 97 | 0,2 |
| 5902.00 | 12 - 24V | 102 | 0,2 |
| 5903.00 | 12 - 24V | 97 | 0,2 |
| 5904.00 | 12 - 24V | 107 | 0,3 |

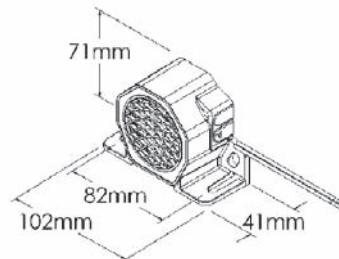

* ■ Sonido Autoajustable / ■ Self-adjusting Sound / ■ Selbseinstellbarer Ton / ■ Son Autorégulé

■ Aplicación / ■ Application / ■ Anwendung / ■ Application



| REF. | Tensión Voltage Spannung Tension | Db | Consumo Consumption Verbrauch Consommation |
|------|---|----|---|
|------|---|----|---|

| | | | |
|-----------|----------|---------|-----|
| * 5908.00 | 12 - 24V | 97 - 0 | 0,2 |
| 5909.00 | 12 - 24V | 90 - 0 | 0,2 |
| 5910.00 | 12 - 24V | 97 - 87 | 0,1 |
| 5911.00 | 12 - 24V | 90 - 0 | 0,2 |

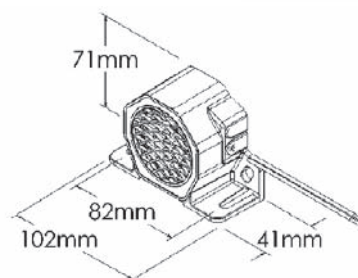

* ■ Sonido Autoajustable / ■ Self-adjusting Sound / ■ Selbseinstellbarer Ton / ■ Son Autorégulé

■ Aplicación / ■ Application / ■ Anwendung / ■ Application



| REF. | Tensión Voltage Spannung Tension | Db | Consumo Consumption Verbrauch Consommation |
|------|---|----|---|
|------|---|----|---|

| | | | |
|---------|-----|----|-----|
| 5913.00 | 12V | 90 | 0,1 |
| 5914.00 | 24V | 90 | 0,1 |

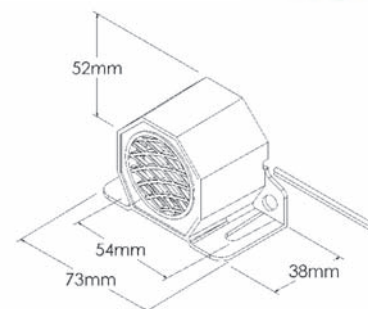

Bocinas + Retroalarmas Horns + Back-up Alarms

Hupe + Rückfahrwarner Avertisseur et Alarme de Recul

■ Aplicación / ■ Application / ■ Anwendung / ■ Application



| REF. | Tensión Voltage Spannung Tension | Db | Consumo Consumption Verbrauch Consommation |
|------|---|----|---|
|------|---|----|---|

| | | | |
|-----------|----------|----------|-----|
| * 5905.00 | 12 - 24V | 87 - 112 | 0,4 |
| 5906.00 | 12 - 36V | 112 | 0,4 |

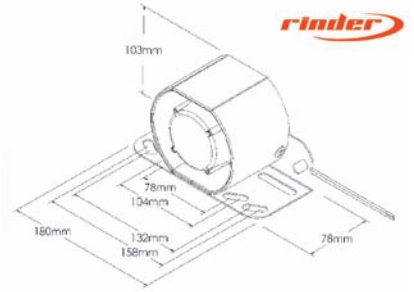

* ■ Sonido Autoajutable / ■ Self-adjusting Sound / ■ Selbststellbarer Ton / ■ Son Autorégulé
 ■ Especial Maquinaria Pesada / ■ Special for Heavy Vehicles / ■ Späziel für Schwere Fahrzeuge / ■ Spécial Charges Lourdes

■ Aplicación / ■ Application / ■ Anwendung / ■ Application



| REF. | Tensión Voltage Spannung Tension | Db | Consumo Consumption Verbrauch Consommation |
|------|---|----|---|
|------|---|----|---|

| | | | |
|---------|----------|-----|-----|
| 5907.00 | 12 - 36V | 107 | 0,4 |
|---------|----------|-----|-----|

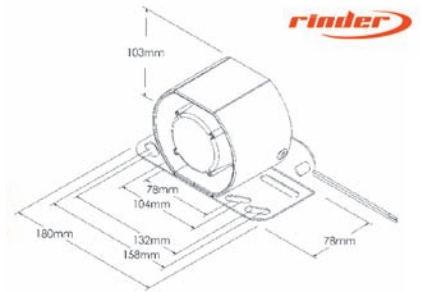

■ Especial Maquinaria Pesada / ■ Special for Heavy Vehicles / ■ Späziel für Schwere Fahrzeuge / ■ Spécial Charges Lourdes

■ Aplicación / ■ Application / ■ Anwendung / ■ Application



| REF. | Tensión Voltage Spannung Tension | Db | Consumo Consumption Verbrauch Consommation |
|------|---|----|---|
|------|---|----|---|

| | | | |
|---------|----------|----|-----|
| 5912.00 | 12 - 24V | 90 | 0,1 |
|---------|----------|----|-----|

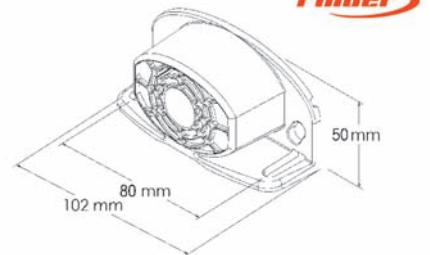

■ Aplicación / ■ Application / ■ Anwendung / ■ Application



| REF. | Tensión Voltage Spannung Tension | Db | Consumo Consumption Verbrauch Consommation |
|------|---|----|---|
|------|---|----|---|

| | | | |
|-------|----------|-----|------|
| 31.00 | 12 - 24V | 108 | 0,3A |
|-------|----------|-----|------|

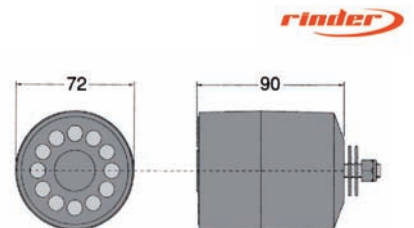

Bocinas + Retroalarmas Horns + Back-up Alarms

Hupe + Rückfahrwarner Avertisseur et Alarme de Recul

■ Aplicación / ■ Application / ■ Anwendung / ■ Application

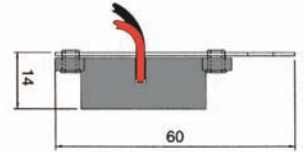
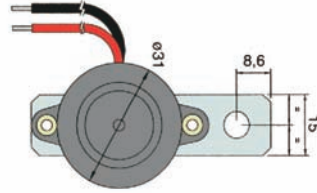
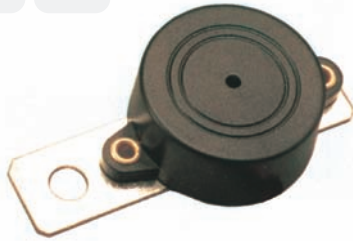

| REF. | Tensión Voltage Spannung Tension | Frecuencia Frequency Frequenz Fréquence | Db | Consumo Consumption Verbrauch Consommation |
|-------|---|--|----|---|
| 34.12 | 12V | 4100 | 85 | 10 mA |
| 34.24 | 24V | 4100 | 90 | 14 mA |

■ Aplicación / ■ Application / ■ Anwendung / ■ Application

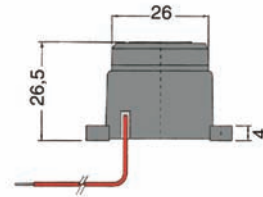
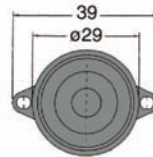

| REF. | Tensión Voltage Spannung Tension | Frecuencia Frequency Frequenz Fréquence | Db | Consumo Consumption Verbrauch Consommation |
|-------|---|--|-----|---|
| | 6V | 4110 | 90 | 4 mA |
| 39.00 | 12V | 4110 | 97 | 8 mA |
| | 24V | 4110 | 102 | 14 mA |

■ Aplicación / ■ Application / ■ Anwendung / ■ Application

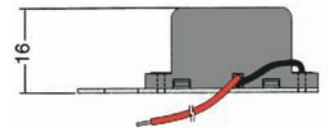
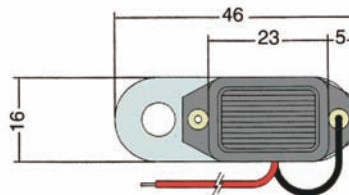
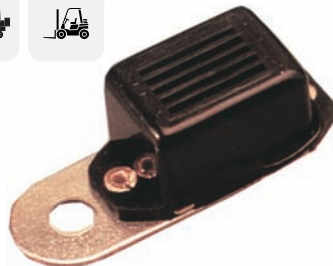

| REF. | Tensión Voltage Spannung Tension | Frecuencia Frequency Frequenz Fréquence | Db | Consumo Consumption Verbrauch Consommation |
|-------|---|--|----|---|
| 66.12 | 12V | 400 | 75 | 25 mA |
| 66.24 | 24V | 400 | 80 | 30 mA |

Bocinas + Retroalarmas Horns + Back-up Alarms

Hupe + Rückfahrwarner Avertisseur et Alarme de Recul

■ Aplicación / ■ Application / ■ Anwendung / ■ Application

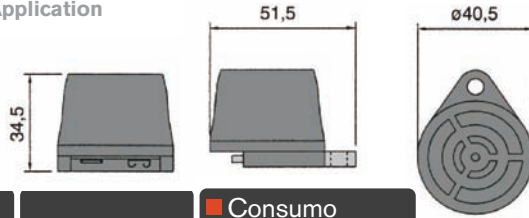

| REF. | Tensión Voltage Spannung Tension | Frecuencia Frequency Frequenz Fréquence | Db | Consumo Consumption Verbrauch Consommation |
|-------|---|--|----|---|
| 67.12 | 12V | 400 ± 100 Hz | 97 | 25 mA |
| 67.24 | 24V | 400 ± 100 Hz | 99 | 21 mA |

■ Aplicación / ■ Application / ■ Anwendung / ■ Application

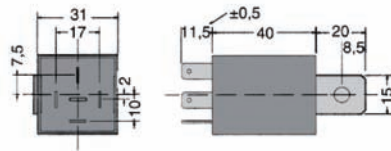

| REF. | Tensión Voltage Spannung Tension | Db |
|-------|---|----|
| 68.00 | 24V | 80 |

■ Aplicación / ■ Application / ■ Anwendung / ■ Application

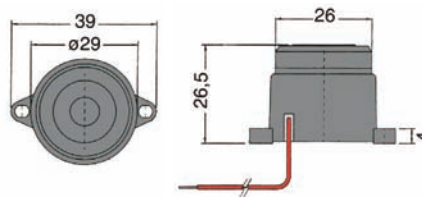

| REF. | Tensión Voltage Spannung Tension | Frecuencia Frequency Frequenz Fréquence | Db | Consumo Consumption Verbrauch Consommation |
|-------|---|--|-----|---|
| 73.12 | 12V | 4100 | 95 | 10 mA |
| 73.24 | 24V | 4100 | 100 | 20 mA |

■ Aplicación / ■ Application / ■ Anwendung / ■ Application

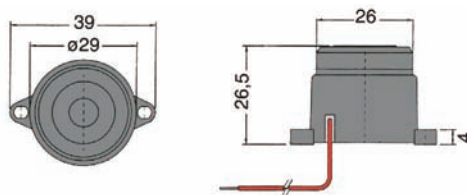

| REF. | Tensión Voltage Spannung Tension | Frecuencia Frequency Frequenz Fréquence | Db | Consumo Consumption Verbrauch Consommation |
|-------|---|--|----|---|
| 24.00 | 12V | 4100 | 95 | 10 mA |

Bocinas + Retroalarmas Horns + Back-up Alarms

Hupe + Rückfahrwarner Avertisseur et Alarme de Recul

■ Aplicación / ■ Application / ■ Anwendung / ■ Application

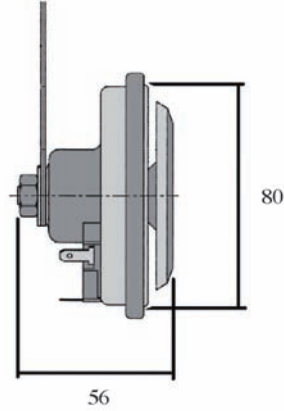
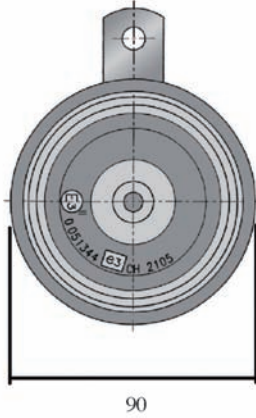

| REF. | Tensión | Frecuencia | Db | Consumo | Agudo | Grave |
|----------|----------|------------|-----|--------------|-------|-------|
| | Voltage | Frequency | | Consumption | High | Low |
| | Spannung | Frequenz | | Verbrauch | Hoch | Tief |
| | Tension | Fréquence | | Consommation | Aigu | Grave |
| 5802A.12 | 12V | 420 | 112 | 3,5 A | ● | |
| 5802G.12 | 12V | 335 | 112 | 3,5 A | | ● |
| 5802A.24 | 24V | 420 | 112 | 2,5 A | ● | |
| 5802G.24 | 24V | 335 | 112 | 2,5 A | | ● |
| 5802A.36 | 36V | 420 | 112 | 1 A | ● | |
| 5802G.36 | 36V | 335 | 112 | 1 A | | ● |
| 5802A.48 | 48V | 420 | 112 | 0,8 A | ● | |
| 5802G.48 | 48V | 335 | 112 | 0,8 A | | ● |
| 5802A.80 | 80V | 420 | 112 | 0,5 A | ● | |
| 5802G.80 | 80V | 335 | 112 | 0,5 A | | ● |

E

■ Aplicación / ■ Application / ■ Anwendung / ■ Application



| REF. | Tensión | Frecuencia | Db | Grave |
|---------|----------|------------|-----|-------|
| | Voltage | Frequency | | Low |
| | Spannung | Frequenz | | Tief |
| | Tension | Fréquence | | Grave |
| 5816.24 | 24V | 180 | 118 | ● |

E

Bocinas + Retroalarmas Horns + Back-up Alarms

Hupe + Rückfahrwarner Avertisseur et Alarme de Recul



■ Aplicación / ■ Application / ■ Anwendung / ■ Application

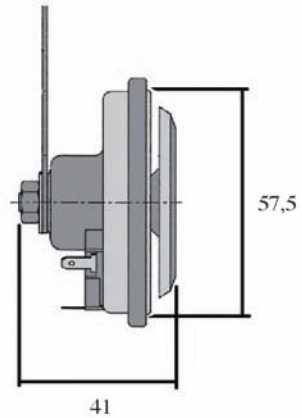
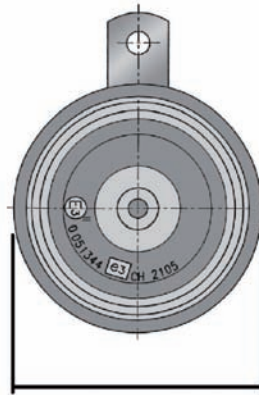

| REF. | Tensión / Voltage / Spannung / Tension | | Frecuencia / Frequency / Frequenz / Fréquence | | Db | Consumo / Consumption / Verbrauch / Consommation | | Agudo / High / Hoch / Aigu | | Grave / Low / Tief / Grave | |
|----------|--|---|---|---|-----|--|---|----------------------------|---|----------------------------|---|
| | ■ | ■ | ■ | ■ | | ■ | ■ | ■ | ■ | ■ | ■ |
| 5800A.12 | 12V | | 420 | | 103 | 1 A | | ● | | | |
| 5800G.12 | 12V | | 335 | | 103 | 1 A | | | | ● | |

(E)

■ Aplicación / ■ Application / ■ Anwendung / ■ Application

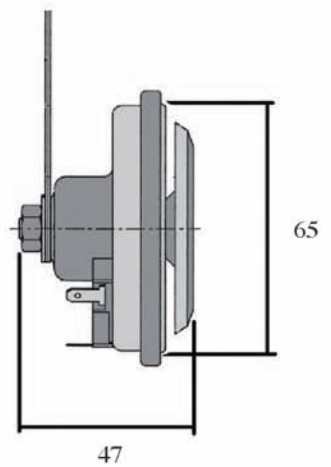
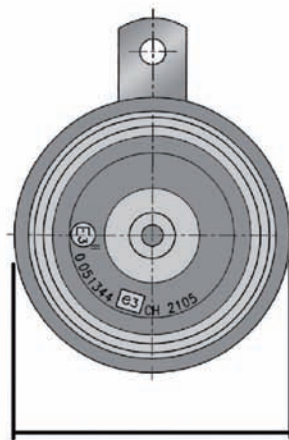

| REF. | Tensión / Voltage / Spannung / Tension | | Frecuencia / Frequency / Frequenz / Fréquence | | Db | Consumo / Consumption / Verbrauch / Consommation | | Agudo / High / Hoch / Aigu | | Grave / Low / Tief / Grave | |
|----------|--|---|---|---|-----|--|---|----------------------------|---|----------------------------|---|
| | ■ | ■ | ■ | ■ | | ■ | ■ | ■ | ■ | ■ | ■ |
| 5801A.12 | 12V | | 420 | | 112 | 1 A | | ● | | | |
| 5801G.12 | 12V | | 340 | | 112 | 1 A | | | | ● | |

(E)

Bocinas + Retroalarmas Horns + Back-up Alarms

Hupe + Rückfahrwarner Avertisseur et Alarme de Recul

■ Aplicación / ■ Application / ■ Anwendung / ■ Application

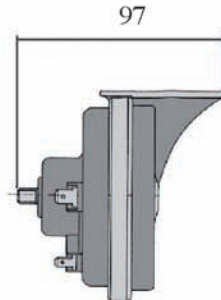
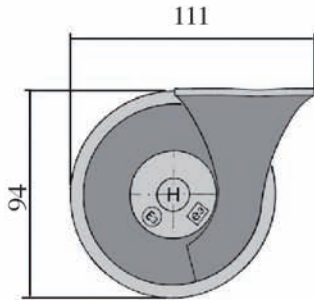

| REF. | Tensión | Frecuencia | Db | Consumo |
|------|----------|------------|----|--------------|
| | Voltage | Frequency | | Consumption |
| | Spannung | Frequenz | | Verbrauch |
| | Tension | Fréquence | | Consommation |

| | | | | |
|---------|-----|------------|-----|------|
| 5804.12 | 12V | 490/410 Hz | 112 | 10 A |
| 5804.24 | 24V | 490/410 Hz | 112 | 7 A |

■ Bocinas + Soporte + Relé / ■ Horn+Support+Relé / ■ Hupe + Halterung + Schaltrelais / ■ Klaxons+Support+Relais
 ■ Sonido Agudo - Grave / ■ High-Low Tone / ■ Hoch/Tief Ton / ■ Son Aigu-Grave

E

■ Aplicación / ■ Application / ■ Anwendung / ■ Application

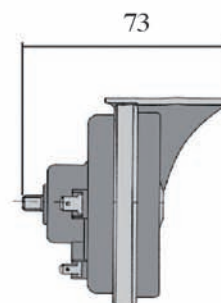
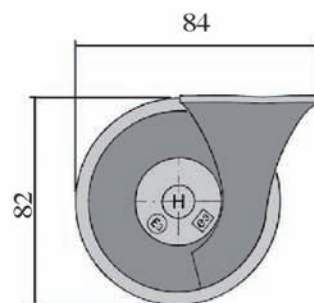

| REF. | Tensión | Frecuencia | Db | Consumo |
|------|----------|------------|----|--------------|
| | Voltage | Frequency | | Consumption |
| | Spannung | Frequenz | | Verbrauch |
| | Tension | Fréquence | | Consommation |

| | | | | |
|---------|-----|------------|-----|-----|
| 5805.12 | 12V | 510/430 Hz | 112 | 5 A |
|---------|-----|------------|-----|-----|

■ Bocinas + Soporte + Relé / ■ Horn+Support+Relé / ■ Hupe + Halterung + Schaltrelais / ■ Klaxons+Support+Relais
 ■ Sonido Agudo - Grave / ■ High-Low Tone / ■ Hoch/Tief Ton / ■ Son Aigu-Grave

E

Bocinas + Retroalarmas Horns + Back-up Alarms

Hupe + Rückfahrwarner Avertisseur et Alarme de Recul

■ Aplicación / ■ Application / ■ Anwendung / ■ Application

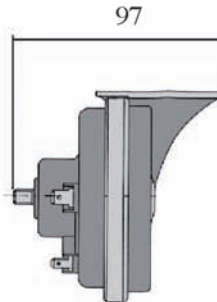
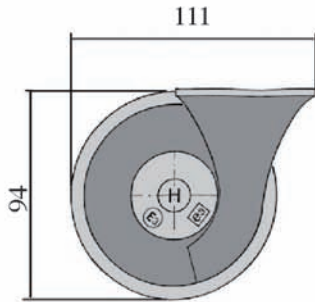

| REF. | Tensión Voltage Spannung Tension | Frecuencia Frequency Frequenz Fréquence | Db | Consumo Consumption Verbrauch Consommation |
|---------|---|--|-----|---|
| 5806.12 | 12V | 490/410 Hz | 112 | 10 A |

■ Bocinas + Soporte + Relé / ■ Horn+Support+Relé / ■ Hupe + Halterung + Schaltrelais / ■ Klaxons+Support+Relais
 ■ Sonido Agudo - Grave / ■ High-Low Tone / ■ Hoch/Tief Ton / ■ Son Aigu-Grave

■ Aplicación / ■ Application / ■ Anwendung / ■ Application

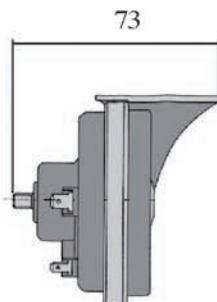
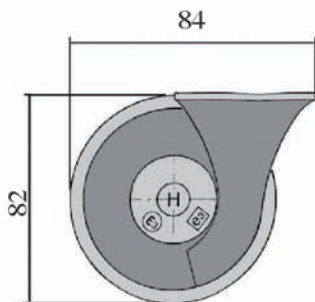

| REF. | Tensión Voltage Spannung Tension | Frecuencia Frequency Frequenz Fréquence | Db | Consumo Consumption Verbrauch Consommation |
|---------|---|--|-----|---|
| 5807.12 | 12V | 510/430 Hz | 112 | 5 A |

■ Bocinas + Soporte + Relé / ■ Horn+Support+Relé / ■ Hupe + Halterung + Schaltrelais / ■ Klaxons+Support+Relais
 ■ Sonido Agudo - Grave / ■ High-Low Tone / ■ Hoch/Tief Ton / ■ Son Aigu-Grave

Bocinas + Retroalarmas Horns + Back-up Alarms

Hupe + Rückfahrwarner Avertisseur et Alarme de Recul



■ Aplicación / ■ Application / ■ Anwendung / ■ Application

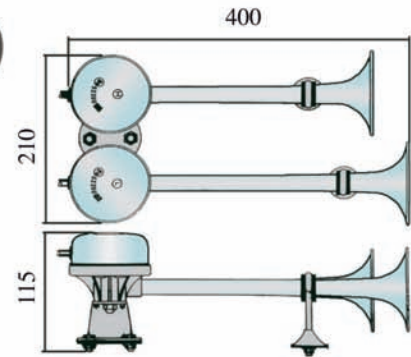

| REF. | Tensión Voltage Spannung Tension | Frecuencia Frequency Frequenz Fréquence | Db | Consumo Consumption Verbrauch Consommation |
|------|---|--|----|---|
|------|---|--|----|---|

5808.24 24V 440/390 Hz 115 8 A

■ Sonido Agudo - Grave / ■ High-Low Tone / ■ Hoch/Tief Ton / ■ Son Aigu-Grave



■ Aplicación / ■ Application / ■ Anwendung / ■ Application

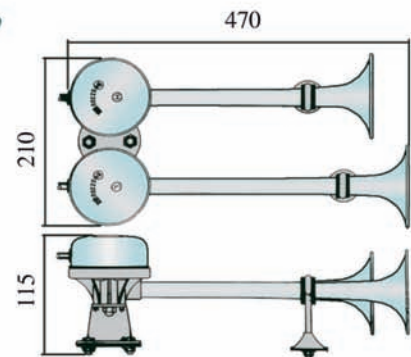

| REF. | Tensión Voltage Spannung Tension | Frecuencia Frequency Frequenz Fréquence | Db | Consumo Consumption Verbrauch Consommation |
|------|---|--|----|---|
|------|---|--|----|---|

5809.24 24V 370/320 Hz 115 8 A

■ Sonido Agudo - Grave / ■ High-Low Tone / ■ Hoch/Tief Ton / ■ Son Aigu-Grave



Bocinas + Retroalarmas Horns + Back-up Alarms

Hupe + Rückfahrwarner Avertisseur et Alarme de Recul

■ Aplicación / ■ Application / ■ Anwendung / ■ Application

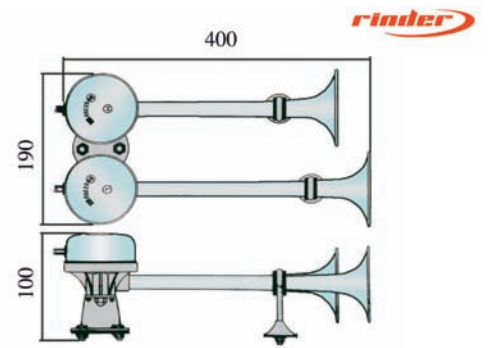

rinder

(E)

| REF. | Tensión Voltage Spannung Tension | Frecuencia Frequency Frequenz Fréquence | Db | Agudo High Hoch Aigu | Grave Low Tief Grave |
|---------|---|--|-----|-------------------------------|-------------------------------|
| 5811.00 | | 440/340 Hz | 118 | ● | ● |

■ Aplicación / ■ Application / ■ Anwendung / ■ Application

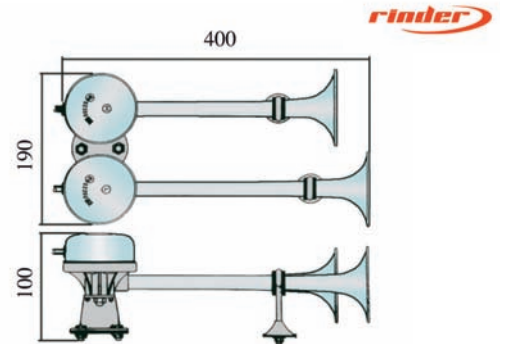

rinder

(E)

| REF. | Tensión Voltage Spannung Tension | Frecuencia Frequency Frequenz Fréquence | Db | Agudo High Hoch Aigu | Grave Low Tief Grave |
|---------|---|--|-----|-------------------------------|-------------------------------|
| 5811.01 | | 430/340 Hz | 118 | ● | ● |

■ Conexión Neumática Rápida / ■ Fast Neumatic Connection / ■ Schnellluftanschluss / ■ Connexion Pneumatique Rapide

■ Aplicación / ■ Application / ■ Anwendung / ■ Application

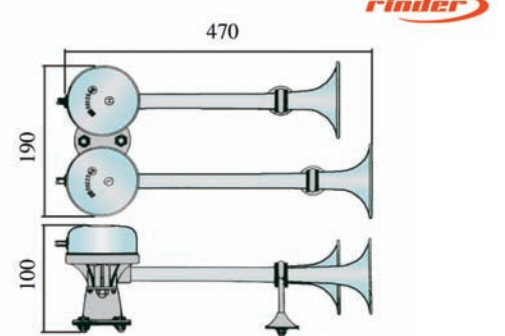

rinder

(E)

| REF. | Tensión Voltage Spannung Tension | Frecuencia Frequency Frequenz Fréquence | Db | Agudo High Hoch Aigu | Grave Low Tief Grave |
|---------|---|--|-----|-------------------------------|-------------------------------|
| 5812.00 | 24V | 440/340 Hz | 118 | ● | ● |

Bocinas + Retroalarmas Horns + Back-up Alarms

Hupe + Rückfahrwarner Avertisseur et Alarme de Recul

■ Aplicación / ■ Application / ■ Anwendung / ■ Application

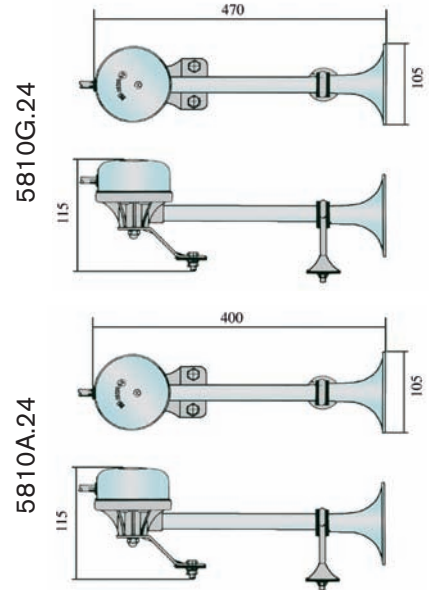

| REF. | Tensión Voltage Spannung Tension | Frecuencia Frequency Frequenz Fréquence | Db | Agudo High Hoch Aigu | Grave Low Tief Grave |
|----------|---|--|-----|-------------------------------|-------------------------------|
| 5810A.24 | 24V | 370 Hz | 112 | ● | |
| 5810G.24 | 24V | 320 Hz | 112 | | ● |



■ Aplicación / ■ Application / ■ Anwendung / ■ Application

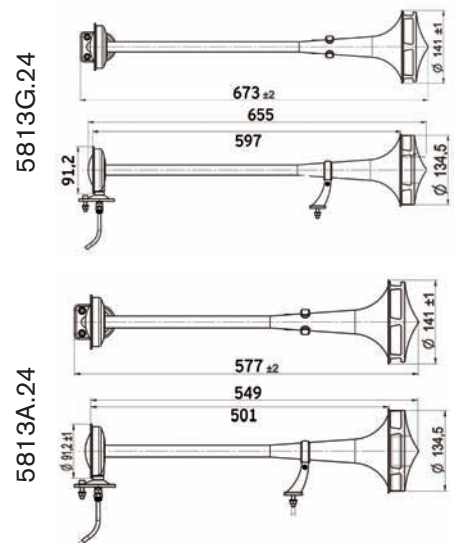

| REF. | Tensión Voltage Spannung Tension | Frecuencia Frequency Frequenz Fréquence | Db | Agudo High Hoch Aigu | Grave Low Tief Grave |
|----------|---|--|-----|-------------------------------|-------------------------------|
| 5813A.24 | | 200 Hz | 118 | ● | |
| 5813G.24 | | 180 Hz | 118 | | ● |



Bocinas + Retroalarmas Horns + Back-up Alarms

Hupe + Rückfahrwarner Avertisseur et Alarme de Recul

■ Aplicación / ■ Application / ■ Anwendung / ■ Application



5814.00

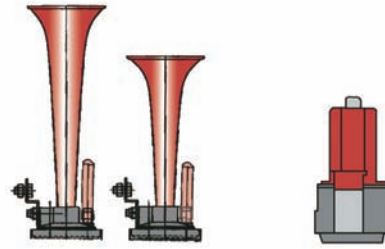

5815.00

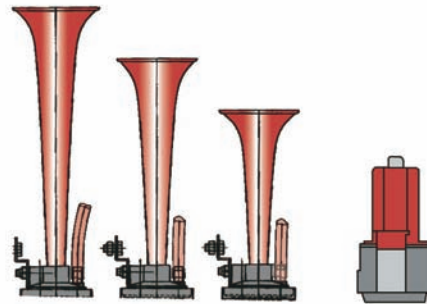

| REF. | Tensión Voltage Spannung Tension | Frecuencia Frequency Frequenz Fréquence | Db |
|---------|---|--|---------|
| 5814.00 | 12V | 617/750 Hz | 105/118 |
| 5815.00 | 12V | 510/610/750 Hz | 105/118 |

■ Aplicación / ■ Application / ■ Anwendung / ■ Application



REF. 5817



REF. 5818



REF. 5819.12 / 5819.24

| REF. | Tensión Voltage Spannung Tension | Presión Pressure Druck Pression | Peso Weight Gewicht Poids |
|---------|---|--|------------------------------------|
| 5817.00 | | Max 1000 KPa | 120 gr |
| 5818.00 | | Max 1000 KPa | 200 gr |
| 5819.12 | 12V | Max 1000 KPa | 190 gr |
| 5819.24 | 24V | Max 1000 KPa | 190 gr |

Desconectores
Switch Isolators
Batteriehauptschalter
Coupe Batterie

Power is
yours

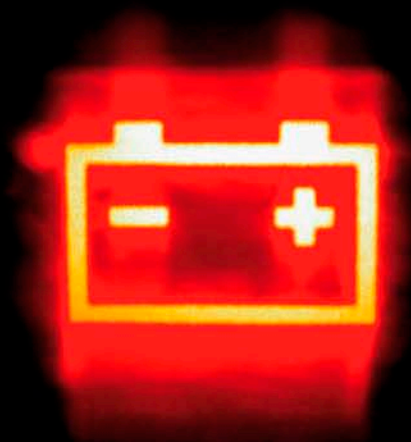

OFF

Desconectores Switch Isolators

Batteriehauptschalter Coupe Batterie

■ Aplicación / ■ Application / ■ Anwendung / ■ Application

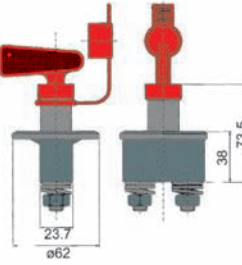

REF.
110.00

■ Aplicación / ■ Application / ■ Anwendung / ■ Application

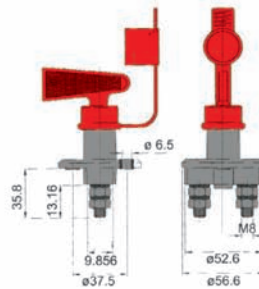

REF.
111.00

■ Aplicación / ■ Application / ■ Anwendung / ■ Application

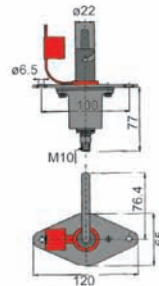

REF.
112.00

■ Aplicación / ■ Application / ■ Anwendung / ■ Application

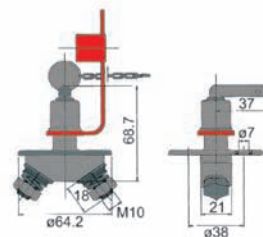

REF.
113.00

■ Aplicación / ■ Application / ■ Anwendung / ■ Application

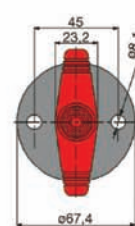
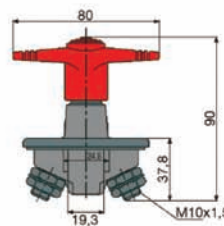

REF.
124.00

Reductores de Tensión + Cargadores de Batería
Tension Reducer + Battery Shipper
Spannunggetriebe + Batterieladegerät
Reducteur de Tension + Chargeur de Batterie



Best
charge
for you

Reductores de Tensión + Cargadores de Batería
Tension Reducer + Battery Shipper

Spannunggetriebe + Batterieladegerät
Reducteur de Tension + Chargeur de Batterie

■ Aplicación / ■ Application / ■ Anwendung / ■ Application

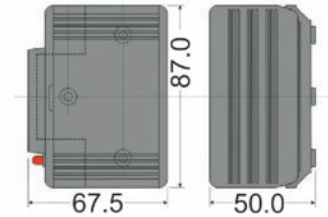

| REF. | Tensión Entrada Entrance Voltage Spannung Eintritt Tension d'entrée | Tensión Salida Exit Voltage Spannung Ausgang Tension de Sortie | Carga Continua Direct Load Gleichladung Charge Constante | Carga Intermitente Máxima Maximum Intermittent Load Maximaler Veränderlicher Last Charge Alternative Maximum |
|-------|--|---|---|---|
| 79.03 | 24V | 12V | 3A | 6A |

■ Aplicación / ■ Application / ■ Anwendung / ■ Application

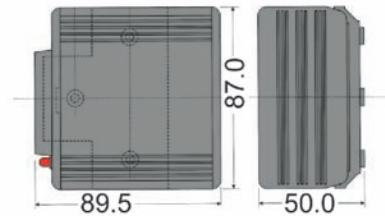

ESTE SERA EL 79.06 NO?

| REF. | Tensión Entrada Entrance Voltage Spannung Eintritt Tension d'entrée | Tensión Salida Exit Voltage Spannung Ausgang Tension de Sortie | Carga Continua Direct Load Gleichladung Charge Constante | Carga Intermitente Máxima Maximum Intermittent Load Maximaler Veränderlicher Last Charge Alternative Maximum |
|-------|--|---|---|---|
| 79.06 | 24V | 12V | 6A | 10A |

■ Aplicación / ■ Application / ■ Anwendung / ■ Application

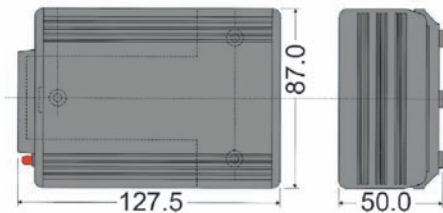

| REF. | Tensión Entrada Entrance Voltage Spannung Eintritt Tension d'entrée | Tensión Salida Exit Voltage Spannung Ausgang Tension de Sortie | Carga Continua Direct Load Gleichladung Charge Constante | Carga Intermitente Máxima Maximum Intermittent Load Maximaler Veränderlicher Last Charge Alternative Maximum |
|-------|--|---|---|---|
| 79.12 | 24V | 12V | 12A | 18A |

Reductores de Tensión + Cargadores de Batería
Tension Reducer + Battery Shipper

Spannunggetriebe + Batterieladegerät
Reducteur de Tension + Chargeur de Batterie

■ Aplicación / ■ Application / ■ Anwendung / ■ Application

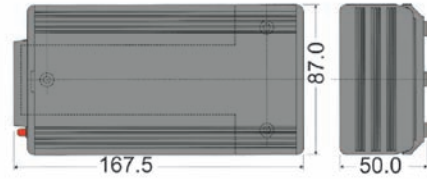

| REF. | Tensión Entrada Entrance Voltage Spannung Eintritt Tension d'entrée | Tensión Salida Exit Voltage Spannung Ausgang Tension de Sortie | Carga Continua Direct Load Gleichladung Charge Constante | Carga Intermitente Máxima Maximum Intermittent Load Maximaler Veränderlicher Last Charge Alternative Maximum |
|-------|--|---|---|---|
| 79.18 | 24V | 12V | 18A | 21A |

■ Aplicación / ■ Application / ■ Anwendung / ■ Application

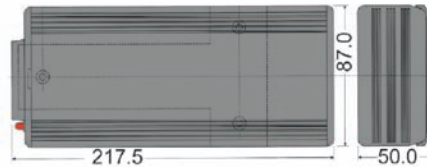

| REF. | Tensión Entrada Entrance Voltage Spannung Eintritt Tension d'entrée | Tensión Salida Exit Voltage Spannung Ausgang Tension de Sortie | Carga Continua Direct Load Gleichladung Charge Constante | Carga Intermitente Máxima Maximum Intermittent Load Maximaler Veränderlicher Last Charge Alternative Maximum |
|-------|--|---|---|---|
| 79.24 | 24V | 12V | 24A | 30A |

■ Aplicación / ■ Application / ■ Anwendung / ■ Application

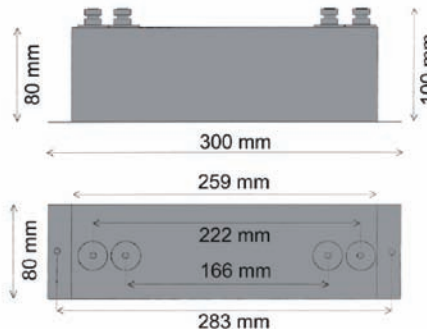

| REF. | Tensión Entrada Entrance Voltage Spannung Eintritt Tension d'entrée | Tensión Salida Exit Voltage Spannung Ausgang Tension de Sortie | Carga Continua Direct Load Gleichladung Charge Constante | Carga Intermitente Máxima Maximum Intermittent Load Maximaler Veränderlicher Last Charge Alternative Maximum |
|-------|--|---|---|---|
| 79.50 | 24V | 12V | 50A | 60A |

Reductores de Tensión + Cargadores de Batería
Tension Reducer + Battery Shipper

Spannunggetriebe + Batterieladegerät
Reducteur de Tension + Chargeur de Batterie

■ Aplicación / ■ Application / ■ Anwendung / ■ Application



- CARGADOR DE BATERÍA
- BATTERY SHIPPER
- BATTERIELADEGERÄT
- CHARGEUR DE BATTERIE



| REF. | Entrada Entrance Eintritt Entrée | Voltage Nominal Nominal Voltage Spannung Tension Nominale | Carga Máxima Maximum Load Maximale Ladung Charge Maximum |
|---------|---|--|---|
| 1010.12 | 230 vac | 12V | 7A |
| 1010.24 | 230 vac | 24V | 3A |

■ Baterías Plomo Ácido / ■ Acid Lead Battery / ■ Bleibatterie / ■ Batteries Plomb-Acide
 IP67

■ Aplicación / ■ Application / ■ Anwendung / ■ Application



- CARGADOR DE BATERÍA
- BATTERY SHIPPER
- BATTERIELADEGERÄT
- CHARGEUR DE BATTERIE



| REF. | Entrada Entrance Eintritt Entrée | Voltage Nominal Nominal Voltage Spannung Tension Nominale | Carga Máxima Maximum Load Maximale Ladung Charge Maximum |
|---------|---|--|---|
| 1011.12 | 230 vac | 12V | 17A |
| 1011.24 | 230 vac | 24V | 12A |

■ Baterías Plomo Ácido / ■ Acid Lead Battery / ■ Bleibatterie / ■ Batteries Plomb-Acide
 IP67

Conectores + Conexiones Eléctricas
Connectors + Electrical Connections
Buchse + Elektrische Verbindungen
Connecteur + Connexions Électriques

Perfectly
connected
with light

light

Conectores + Conexiones Eléctricas | **Buchse + Elektrische Verbindungen**
Connectors + Electrical Connections | **Connecteur + Connexions Electriques**

■ Aplicación / ■ Application / ■ Anwendung / ■ Application



DIN 9680

| REF. | 6 - 24V | 3 PIN |
|---------|---------|-------|
| 3097.00 | ● | A |
| 3098.00 | ● | B |

(A)

(B)

■ Aplicación / ■ Application / ■ Anwendung / ■ Application



DIN 9680

| REF. | 6 - 24V | 3 PIN |
|---------|---------|-------|
| 3099.00 | ● | A |
| 3088.00 | ● | B |

(A)

(B)

■ Aplicación / ■ Application / ■ Anwendung / ■ Application



ISO 11446

| REF. | 12V | 13 PIN |
|---------|-----|--------|
| 3077.00 | ● | ● |

■ Aplicación / ■ Application / ■ Anwendung / ■ Application



ISO 11446

| REF. | 12V | 13 PIN |
|---------|-----|--------|
| 3081.00 | ● | ● |

Conectores + Conexiones Eléctricas | **Buchse + Elektrische Verbindungen**
Connectors + Electrical Connections | **Connecteur + Connexions Electriques**

■ Aplicación / ■ Application / ■ Anwendung / ■ Application



(A)



(B)

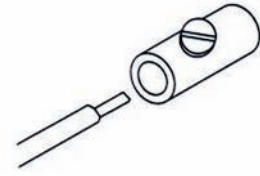

ISO 3732

| REF. | 12V | | |
|---------|-----|---|--|
| 3014.00 | ● | A | |
| 3016.00 | ● | B | |

■ **A:** Plástico **B:** Metálico
 ■ **A:** Plastic **B:** Metallic
 ■ **A:** Kunststoff **B:** Metalic
 ■ **A:** Plastique **B:** Métallique

■ Aplicación / ■ Application / ■ Anwendung / ■ Application



(A)



(B)

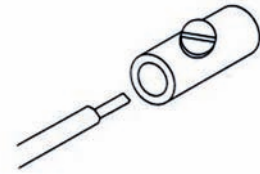

ISO 1724

| REF. | 12V | | |
|---------|-----|---|--|
| 3015.00 | ● | A | |
| 3017.00 | ● | B | |

■ **A:** Plástico **B:** Metálico
 ■ **A:** Plastic **B:** Metallic
 ■ **A:** Kunststoff **B:** Metalic
 ■ **A:** Plastique **B:** Métallique

■ Aplicación / ■ Application / ■ Anwendung / ■ Application



(A)



(B)



ISO 1185

| REF. | 24V | | |
|---------|-----|---|---|
| 3022.00 | ● | A | N |
| 3026.00 | ● | B | N |

■ **A:** Plástico **B:** Metálico
 ■ **A:** Plastic **B:** Metallic
 ■ **A:** Kunststoff **B:** Metalic
 ■ **A:** Plastique **B:** Métallique

■ Aplicación / ■ Application / ■ Anwendung / ■ Application



(A)



(B)

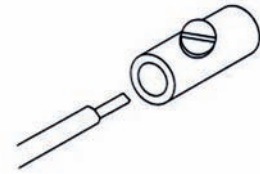

ISO 3731

| REF. | 24V | | |
|---------|-----|---|---|
| 3024.00 | ● | A | S |
| 3028.00 | ● | B | S |

■ **A:** Plástico **B:** Metálico
 ■ **A:** Plastic **B:** Metallic
 ■ **A:** Kunststoff **B:** Metalic
 ■ **A:** Plastique **B:** Métallique

Conectores + Conexiones Eléctricas | **Buchse + Elektrische Verbindungen**
Connectors + Electrical Connections | **Connecteur + Connexions Electriques**

■ Aplicación / ■ Application / ■ Anwendung / ■ Application



(A)



(B)

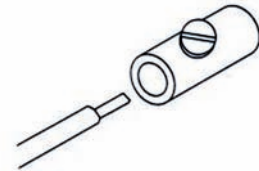

ISO 1185

| REF. | 24V | | |
|---------|-----|---|---|
| 3093.00 | ● | A | N |
| 3027.00 | ● | B | N |

■ **A:** Plástico **B:** Metálico
 ■ **A:** Plastic **B:** Metallic
 ■ **A:** Kunststoff **B:** Metalic
 ■ **A:** Plastique **B:** Métallique

■ Aplicación / ■ Application / ■ Anwendung / ■ Application



(A)



(B)

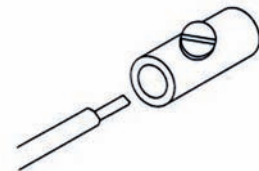

ISO 3731

| REF. | 24V | | |
|---------|-----|---|---|
| 3094.00 | ● | A | S |
| 3029.00 | ● | B | S |

■ **A:** Plástico **B:** Metálico
 ■ **A:** Plastic **B:** Metallic
 ■ **A:** Kunststoff **B:** Metalic
 ■ **A:** Plastique **B:** Métallique

■ Aplicación / ■ Application / ■ Anwendung / ■ Application



(A)



(B)



ISO 1185

| REF. | 24V | | |
|---------|-----|---|---|
| 3023.00 | ● | A | N |
| 3095.00 | ● | B | N |

■ **A:** Plástico **B:** Metálico
 ■ **A:** Plastic **B:** Metallic
 ■ **A:** Kunststoff **B:** Metalic
 ■ **A:** Plastique **B:** Métallique

■ Aplicación / ■ Application / ■ Anwendung / ■ Application



(A)



(B)

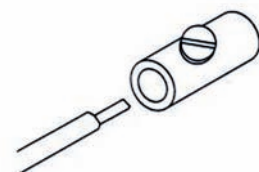

ISO 3731

| REF. | 24V | | |
|---------|-----|---|---|
| 3025.00 | ● | A | S |
| 3096.00 | ● | B | S |

■ **A:** Plástico **B:** Metálico
 ■ **A:** Plastic **B:** Metallic
 ■ **A:** Kunststoff **B:** Metalic
 ■ **A:** Plastique **B:** Métallique

Conectores + Conexiones Eléctricas
Connectors + Electrical Connections

Buchse + Elektrische Verbindungen
Connecteur + Connexions Electriques

■ Aplicación / ■ Application / ■ Anwendung / ■ Application

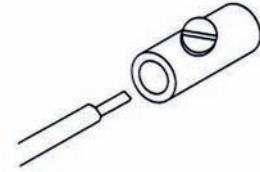

**ADR
 ISO 7638-1**

| | | | |
|---------|-----|-----------|---------|
| REF. | 24V | | |
| 3018.00 | ● | ABS / EBS | 3051.11 |

■ Aplicación / ■ Application / ■ Anwendung / ■ Application

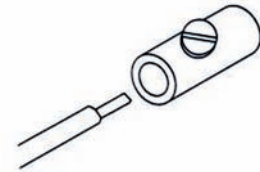

**ADR
 ISO 7638-1**

| | | | |
|---------|-----|-----------|---------|
| REF. | 24V | | |
| 3019.00 | ● | ABS / EBS | 3052.11 |

■ Aplicación / ■ Application / ■ Anwendung / ■ Application

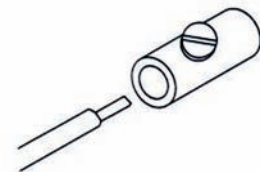

**ADR
 ISO 12098**

| | | | |
|---------|-----|---|-----|
| REF. | 24V | | |
| 3070.00 | ● | A | 13P |
| 3071.00 | ● | B | 15P |

■ Aplicación / ■ Application / ■ Anwendung / ■ Application

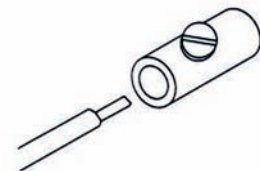

**ADR
 ISO 12098**

| | | | |
|---------|-----|---|-----|
| REF. | 24V | | |
| 3072.00 | ● | A | 13P |
| 3073.00 | ● | B | 15P |

Conectores + Conexiones Eléctricas
Connectors + Electrical Connections

Buchse + Elektrische Verbindungen
Connecteur + Connexions Electriques

■ Aplicación / ■ Application / ■ Anwendung / ■ Application



13P ISO 11446
7P ISO 1724

| | | |
|---------|-----|--|
| REF. | 12V | ■ Adaptador ■ Adapter ■ Adapter ■ Adaptateurs |
| 3091.00 | ● | 13P / 7P |

■ Aplicación / ■ Application / ■ Anwendung / ■ Application



13P ISO 11446
7P ISO 1724

| | | |
|---------|-----|--|
| REF. | 12V | ■ Adaptador ■ Adapter ■ Adapter ■ Adaptateurs |
| 3092.00 | ● | 13P / 7P |

■ Aplicación / ■ Application / ■ Anwendung / ■ Application



15P ISO 12098
7PN ISO 1185
7PS ISO 3731

| | | |
|---------|-----|--|
| REF. | 24V | ■ Adaptador ■ Adapter ■ Adapter ■ Adaptateurs |
| 3020.00 | ● | 15P / 7PN - 7PS |

■ Aplicación / ■ Application / ■ Anwendung / ■ Application



15P ISO 12098
7PN ISO 1185
7PS ISO 3731

| | | |
|---------|-----|--|
| REF. | 24V | ■ Adaptador ■ Adapter ■ Adapter ■ Adaptateurs |
| 3058.00 | ● | 15P / 7PN - 7PS |

Conectores + Conexiones Eléctricas
Connectors + Electrical Connections

Buchse + Elektrische Verbindungen
Connecteur + Connexions Electriques

■ Aplicación / ■ Application / ■ Anwendung / ■ Application



| REF. | 12/24V | ■ Cable L ■ Cable L ■ Kabel L ■ Câble L |
|---------|--------|--|
| 3036.00 | ● | 3 - 4,5M |
| 3036.60 | ● | 6 - 7,5M |

■ Aplicación / ■ Application / ■ Anwendung / ■ Application



| REF. | 24V | ■ Cable L ■ Cable L ■ Kabel L ■ Câble L | ■ Conector ■ Connector ■ Buchse ■ Connecteur |
|---------|-----|--|---|
| 3038.00 | ● | 3 - 4,5M | 7N |
| 3038.60 | ● | 6 - 7,5M | 7N |

7PN ISO 1185

■ Aplicación / ■ Application / ■ Anwendung / ■ Application



| REF. | 24V | ■ Cable L ■ Cable L ■ Kabel L ■ Câble L | ■ Conector ■ Plugs ■ Stecker ■ Fiches |
|---------|-----|--|--|
| 3039.00 | ● | 3 - 4,5M | 7S |
| 3039.60 | ● | 6 - 7,5M | 7S |

7PS ISO 3731

■ Aplicación / ■ Application / ■ Anwendung / ■ Application



| REF. | 24V | ■ Cable L ■ Cable L ■ Kabel L ■ Câble L | ■ Conector ■ Connector ■ Buchse ■ Connecteur |
|---------|-----|--|---|
| 3059.00 | ● | 3M - 4,5M | 15 POLOS |
| 3059.60 | ● | 3M - 4,5M | 13 POLOS |

13P/15P ISO 12098

Conectores + Conexiones Eléctricas
Connectors + Electrical Connections

Buchse + Elektrische Verbindungen
Connecteur + Connexions Electriques

■ Aplicación / ■ Application / ■ Anwendung / ■ Application



| | | | |
|---------|-----|-----------|--|
| REF. | 24V | | <ul style="list-style-type: none"> ■ Cable L ■ Cable L ■ Kabel L ■ Câble L |
| 3032.00 | ● | ABS / EBS | 3M - 4,5M |

ADR ISO 7638-1

■ Aplicación / ■ Application / ■ Anwendung / ■ Application

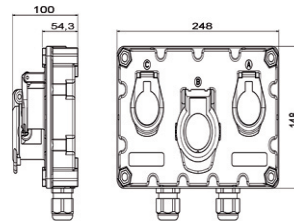

| | | | |
|---------|-----|---|---|
| REF. | 24V | <ul style="list-style-type: none"> ■ Entrada ■ Input ■ Eingang ■ Entrée | <ul style="list-style-type: none"> ■ Salida ■ Output ■ Ausgang ■ Sortie |
| 3144.00 | ● | 1x7N / 1x7S / 1x15P | 1x16P / 4x4P |

15P ISO 12098
7PN ISO 1185
7PS ISO 3731

■ Aplicación / ■ Application / ■ Anwendung / ■ Application

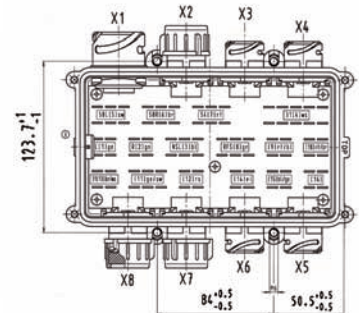
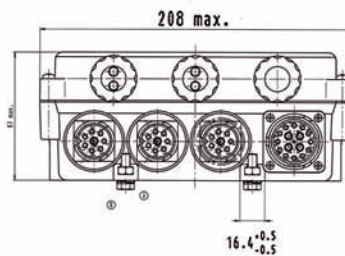

| | |
|---------|-----|
| REF. | 24V |
| 3145.00 | ● |

ADR



Destellantes + Rotativos
Xenon Beacons + Rotating Beacons
Politz Kennleuchten + Rundumkennleuchten
Feu à Eclats + Gyrophares

The best way to
be seen

Destellantes + Rotativos | Politz Kennleuchten + Rundumkennleuchten
Xenon Beacons + Rotating Beacons | Feu à Eclats + Gyrophares

■ Aplicación / ■ Application / ■ Anwendung / ■ Application



42.00



44.00

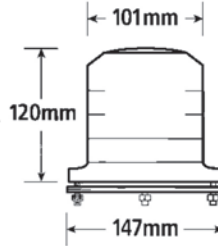

| REF. | Tensión Voltage Spannung Tension |
|------|---|
|------|---|

42.00 12-110V

* 44.00 12-110V

* ■ Magnético / ■ Magnetic / ■ Magnet / ■ Magnétique

■ Aplicación / ■ Application / ■ Anwendung / ■ Application

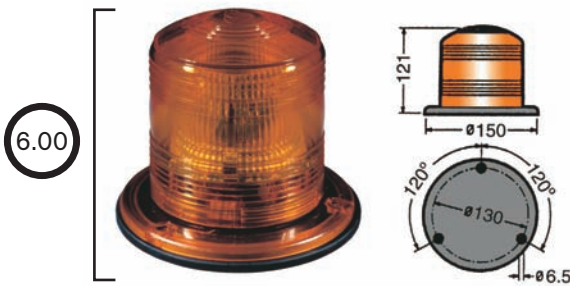

6.00

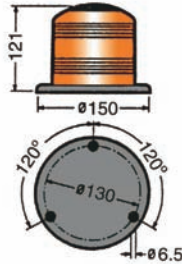

6.50

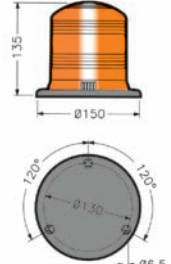
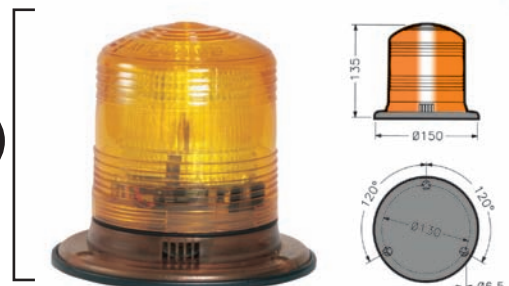

| REF. | Tensión Voltage Spannung Tension | Intensidad Intensity Stärke Intensité | Decibelios Decibels Dezibell Décibels |
|------|---|--|--|
|------|---|--|--|

6.00 10-100V 1-800 Cd

* 6.50 10-100V 1-800 Cd 75/85 dB

* ■ Retroalarma Incorporada / ■ Retroalarm Incorporated / ■ Gebaut Wieder Alarm / ■ Alarme de Recul Incorporée

■ Aplicación / ■ Application / ■ Anwendung / ■ Application

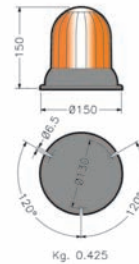

50.00

50.50

| REF. | Tensión Voltage Spannung Tension | Intensidad Intensity Stärke Intensité | Decibelios Decibels Dezibell Décibels |
|------|---|--|--|
|------|---|--|--|

4.00 10-100V 1-800 Cd

50.00 10-100V 1-800 Cd

* 50.50 10-100V 1-800 Cd 75/85 dB

* ■ Retroalarma Incorporada / ■ Retroalarm Incorporated / ■ Gebaut Wieder Alarm / ■ Alarme de Recul Incorporée



4.00

Destellantes + Rotativos | Politz Kennleuchten + Rundumkennleuchten Xenon Beacons + Rotating Beacons | Feu à Eclats + Gyrophares

■ Aplicación / ■ Application / ■ Anwendung / ■ Application



| REF. | Tensión Voltage Spannung Tension | Color Colour Farbe Couleur | |
|-------|---|-------------------------------------|---|
| 40.00 | 12V H1 | Orange | A |
| 41.00 | 24V H1 | Orange | A |
| 88.12 | 12V H1 | Orange | B |
| 88.24 | 24V H1 | Orange | B |



A

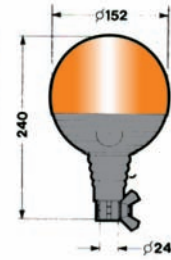

Kg 0.80



B

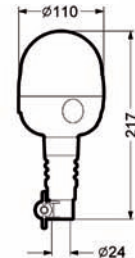

Kg 0,60



E

■ Aplicación / ■ Application / ■ Anwendung / ■ Application



| REF. | Tensión Voltage Spannung Tension | Color Colour Farbe Couleur | |
|-------|---|-------------------------------------|--|
| 85.12 | 12V H1 | Orange | |
| 85.24 | 24V H1 | Orange | |

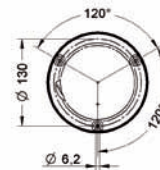
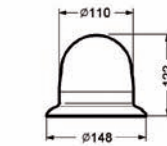

E

■ Aplicación / ■ Application / ■ Anwendung / ■ Application



| REF. | Tensión Voltage Spannung Tension | Color Colour Farbe Couleur | |
|-------|---|-------------------------------------|--|
| 86.12 | 12V H1 | Orange | |
| 86.24 | 24V H1 | Orange | |

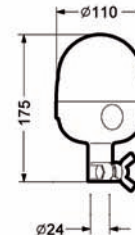

E

■ Aplicación / ■ Application / ■ Anwendung / ■ Application



| REF. | Tensión Voltage Spannung Tension | Color Colour Farbe Couleur | |
|-------|---|-------------------------------------|--|
| 87.12 | 12V H1 | Orange | |
| 87.24 | 24V H1 | Orange | |

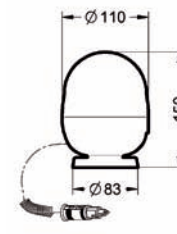

Kg 0,90



E

Destellantes + Rotativos | Politz Kennleuchten + Rundumkennleuchten
Xenon Beacons + Rotating Beacons | Feu à Eclats + Gyrophares

■ Aplicación / ■ Application / ■ Anwendung / ■ Application



| REF. | Tensión Voltage Spannung Tension | Color Colour Farbe Couleur |
|-------|---|-------------------------------------|
| 48.12 | 12V H1 | Orange |
| 48.24 | 24V H1 | Orange |

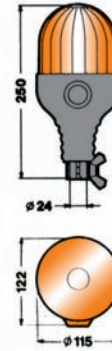

(E)

■ Aplicación / ■ Application / ■ Anwendung / ■ Application



| REF. | Tensión Voltage Spannung Tension | Color Colour Farbe Couleur | Tulipa Lens Linse Cabocon |
|-------|---|-------------------------------------|------------------------------------|
| 46.00 | 12V H1 | Orange | 57.11 |
| 45.00 | 24V H1 | Orange | 57.11 |

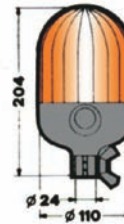

(E)

■ Aplicación / ■ Application / ■ Anwendung / ■ Application



| REF. | Tensión Voltage Spannung Tension | Color Colour Farbe Couleur | Tulipa Lens Linse Cabocon |
|-------|---|-------------------------------------|------------------------------------|
| 51.00 | 12V H1 | Orange | 57.11 |
| 52.00 | 24V H1 | Orange | 57.11 |
| 53.00 | 12V H1 | Blue | 58.11 |
| 54.00 | 24V H1 | Blue | 58.11 |

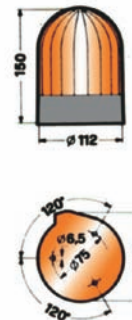

(E)

■ Aplicación / ■ Application / ■ Anwendung / ■ Application



| REF. | Tensión Voltage Spannung Tension | Color Colour Farbe Couleur | Tulipa Lens Linse Cabocon |
|-------|---|-------------------------------------|------------------------------------|
| 55.00 | 12V H1 | Orange | 57.11 |
| 56.00 | 24V H1 | Orange | 57.11 |

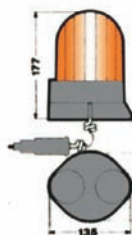

(E)

■ Magnético / ■ Magnetic / ■ Magnet / ■ Magnétique

Destellantes + Rotativos | Politz Kennleuchten + Rundumkennleuchten
Xenon Beacons + Rotating Beacons | **Feu à Eclats + Gyrophares**

■ Aplicación / ■ Application / ■ Anwendung / ■ Application



| REF. | Tensión Voltage Spannung Tension | Color Colour Farbe Couleur |
|-------|---|-------------------------------------|
| 35.00 | 12V H1 | ● |
| 36.00 | 24V H1 | ● |

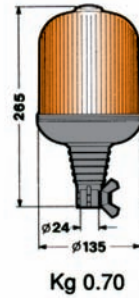

■ Aplicación / ■ Application / ■ Anwendung / ■ Application



| REF. | Tensión Voltage Spannung Tension | Color Colour Farbe Couleur | Tulipa Lens Linse Cabochoon |
|-------|---|-------------------------------------|--------------------------------------|
| 25.00 | 12V H1 | ● | 37.11 |
| 26.00 | 24V H1 | ● | 37.11 |

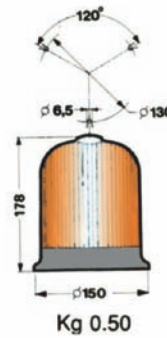

■ Aplicación / ■ Application / ■ Anwendung / ■ Application



| REF. | Tensión Voltage Spannung Tension | Color Colour Farbe Couleur | Tulipa Lens Linse Cabochoon |
|-------|---|-------------------------------------|--------------------------------------|
| 27.00 | 12V H1 | ● | 37.11 |
| 28.00 | 24V H1 | ● | 37.11 |

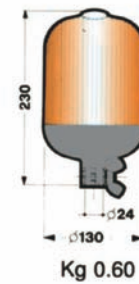

■ Aplicación / ■ Application / ■ Anwendung / ■ Application



| REF. | Tensión Voltage Spannung Tension | Color Colour Farbe Couleur | Tulipa Lens Linse Cabochoon |
|-------|---|-------------------------------------|--------------------------------------|
| 49.12 | 12V H1 | ● | 60.11 |
| 49.24 | 24V H1 | ● | 60.11 |

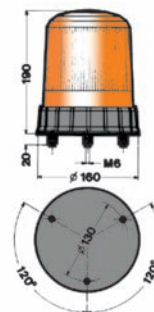

Destellantes + Rotativos
Xenon Beacons + Rotating Beacons

Politz Kennleuchten + Rundumkennleuchten
Feu à Eclats + Gyrophares

■ Aplicación / ■ Application / ■ Anwendung / ■ Application



| REF. | Tensión Voltage Spannung Tension | Color Colour Farbe Couleur | Tulipa Lens Linse Cabochon |
|------|---|-------------------------------------|-------------------------------------|
|------|---|-------------------------------------|-------------------------------------|

| | | | |
|-------|-----------|--------|-------|
| 10.00 | 12/24V H1 | Orange | 18.11 |
| 11.00 | 12/24V H1 | Blue | 19.11 |
| 12.00 | 12/24V H1 | Red | 20.11 |

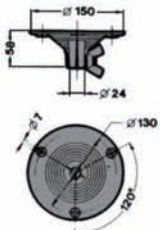

REF 13.00

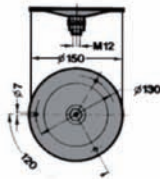

REF 14.00

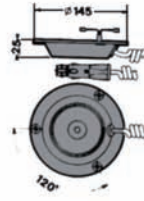

REF 15.00

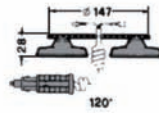

REF 16.00

E

■ Aplicación / ■ Application / ■ Anwendung / ■ Application



REF.

2704.11
3008.11



REF 2704.11



REF 3008.11

■ Aplicación / ■ Application / ■ Anwendung / ■ Application



REF.

3007.11
3011.11



REF 3007.11



REF 3011.11

Destellantes + Rotativos
Xenon Beacons + Rotating Beacons

Politz Kennleuchten + Rundumkennleuchten
Feu à Eclats + Gyrophares



■ Aplicación / ■ Application / ■ Anwendung / ■ Application

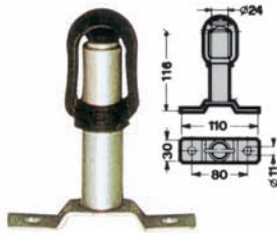

B

REF 90.00



S

REF 91.00

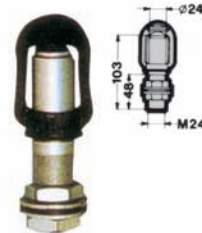

F

REF 95.00

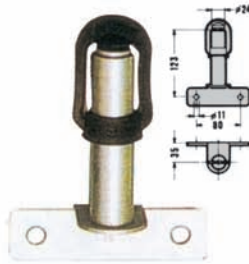

SP

REF 98.00

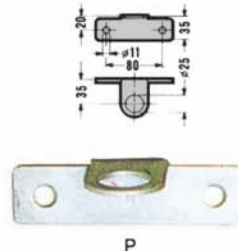

P

REF 96.00

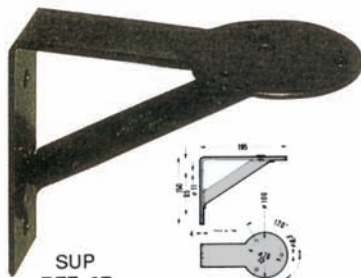
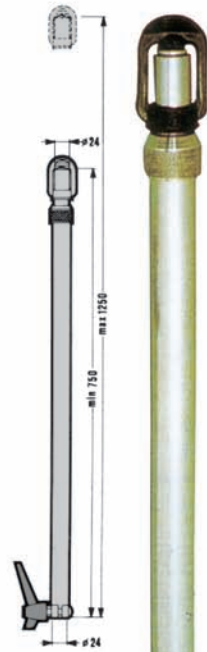

SUP

REF 97.00

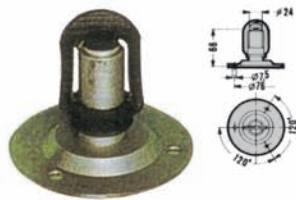

R

REF 84.00

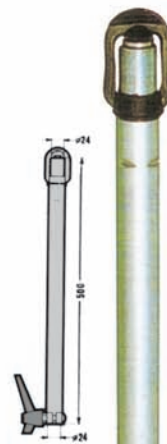

SPR

REF 93.00



SPRT

REF 94.00



REF 83.00

Destellantes + Rotativos | Politz Kennleuchten + Rundumkennleuchten

Xenon Beacons + Rotating Beacons | Feu à Eclats + Gyrophares

■ Aplicación / ■ Application / ■ Anwendung / ■ Application



rinder

| REF. | Tensión Voltage Spannung Tension | Color Colour Farbe Couleur | Rotativos Beacons Drehlicht Gyrophares | Largura Length Länge Longueur |
|--------|---|-------------------------------------|---|--|
| 680.12 | 12V | Orange | 2 | 0,57 m. |
| 680.62 | 12V | Blue | 2 | 0,57 m. |
| 680.24 | 24V | Orange | 2 | 0,57 m. |
| 680.74 | 24V | Blue | 2 | 0,57 m. |

(E)

■ Aplicación / ■ Application / ■ Anwendung / ■ Application



rinder

| REF. | Tensión Voltage Spannung Tension | Color Colour Farbe Couleur | Rotativos Beacons Drehlicht Gyrophares | Largura Length Länge Longueur | Centro iluminado Illuminated center Schriftfeld beleuchtbar Avec éclairage centre |
|--------|---|-------------------------------------|---|--|--|
| 681.12 | 12V | Orange | 2 | 0,74 m. | |
| 681.62 | 12V | Blue | 2 | 0,74 m. | |
| 681.24 | 24V | Orange | 2 | 0,74 m. | |
| 681.74 | 24V | Blue | 2 | 0,74 m. | |

(E)

■ Aplicación / ■ Application / ■ Anwendung / ■ Application



rinder

| REF. | Tensión Voltage Spannung Tension | Color Colour Farbe Couleur | Rotativos Beacons Drehlicht Gyrophares | Largura Length Länge Longueur | Centro iluminado Illuminated center Schriftfeld beleuchtbar Avec éclairage centre |
|--------|---|-------------------------------------|---|--|--|
| 682.12 | 12V | Orange | 2 | 1 m. | |
| 682.62 | 12V | Blue | 2 | 1 m. | |
| 682.24 | 24V | Orange | 2 | 1 m. | |
| 682.74 | 24V | Blue | 2 | 1 m. | |

(E)

Destellantes + Rotativos | Politz Kennleuchten + Rundumkennleuchten

Xenon Beacons + Rotating Beacons | Feu à Eclats + Gyrophares

■ Aplicación / ■ Application / ■ Anwendung / ■ Application



rinder

| REF. | Tensión | Color | Rotativos | Largura | Centro iluminado |
|--------|----------|---------|------------|----------|-------------------------|
| | Voltage | Colour | Beacons | Length | |
| | Spannung | Farbe | Drehlicht | Länge | Schriftfeld beleuchtbar |
| | Tension | Couleur | Gyrophares | Longueur | Avec eclaireage centre |
| 683.12 | 12V | Orange | 2 | 1,20 m. | |
| 683.62 | 12V | Blue | 2 | 1,20 m. | |
| 683.24 | 24V | Orange | 2 | 1,20 m. | |
| 683.74 | 24V | Blue | 2 | 1,20 m. | |

(E)

■ Aplicación / ■ Application / ■ Anwendung / ■ Application



rinder

| REF. | Tensión | Color | Rotativos | Largura | Centro iluminado |
|--------|----------|---------|------------|----------|-------------------------|
| | Voltage | Colour | Beacons | Length | |
| | Spannung | Farbe | Drehlicht | Länge | Schriftfeld beleuchtbar |
| | Tension | Couleur | Gyrophares | Longueur | Avec eclaireage centre |
| 684.12 | 12V | Orange | 2 | 1,50 m. | |
| 684.62 | 12V | Blue | 2 | 1,50 m. | |
| 684.24 | 24V | Orange | 2 | 1,50 m. | |
| 684.74 | 24V | Blue | 2 | 1,50 m. | |

(E)

■ Aplicación / ■ Application / ■ Anwendung / ■ Application



rinder

| REF. | Tensión | Color | Rotativos | Largura | Centro iluminado |
|--------|----------|---------|------------|----------|-------------------------|
| | Voltage | Colour | Beacons | Length | |
| | Spannung | Farbe | Drehlicht | Länge | Schriftfeld beleuchtbar |
| | Tension | Couleur | Gyrophares | Longueur | Avec eclaireage centre |
| 685.12 | 12V | Orange | 4 | 1,50 m. | |
| 685.62 | 12V | Blue | 4 | 1,50 m. | |
| 685.24 | 24V | Orange | 4 | 1,50 m. | |
| 685.74 | 24V | Blue | 4 | 1,50 m. | |

(E)

Destellantes + Rotativos
Xenon Beacons + Rotating Beacons

Politz Kennleuchten + Rundumkennleuchten
Feu à Eclats + Gyrophares

■ Aplicación / ■ Application / ■ Anwendung / ■ Application



LED 



| REF. | Tensión Voltage Spannung Tension | Color Colour Farbe Couleur | Módulo LED LED unit LED Einheit Module LED | Largura Length Länge Longueur |
|---------|---|-------------------------------------|---|--|
| 664A.12 | 12V | ● | 2 | 0,57 m. |
| 664A.24 | 24V | ● | 2 | 0,57 m. |
| 664.00 | 12/24V | ● | 2 | 0,57 m. |



■ Aplicación / ■ Application / ■ Anwendung / ■ Application



LED 



| REF. | Tensión Voltage Spannung Tension | Color Colour Farbe Couleur | Módulo LED LED unit LED Einheit Module LED | Largura Length Länge Longueur | Centro iluminado Illuminated center Schriftfeld beleuchtbar Avec éclairage centre |
|---------|---|-------------------------------------|---|--|--|
| 665A.12 | 12V | ● | 2 | 0,74 m. | |
| 665A.24 | 24V | ● | 2 | 0,74 m. | |
| 665.00 | 12/24V | ● | 2 | 0,74 m. | |



■ Aplicación / ■ Application / ■ Anwendung / ■ Application



LED 



| REF. | Tensión Voltage Spannung Tension | Color Colour Farbe Couleur | Módulo LED LED unit LED Einheit Module LED | Largura Length Länge Longueur | Centro iluminado Illuminated center Schriftfeld beleuchtbar Avec éclairage centre |
|---------|---|-------------------------------------|---|--|--|
| 666A.00 | 12V | ● | 2 | 1 m. | |
| 666A.24 | 24V | ● | 2 | 1 m. | |
| 666.00 | 12/24V | ● | 2 | 1 m. | |



Destellantes + Rotativos | Politz Kennleuchten + Rundumkennleuchten

Xenon Beacons + Rotating Beacons | Feu à Eclats + Gyrophares

■ Aplicación / ■ Application / ■ Anwendung / ■ Application



LED



| REF. | Tensión Voltage Spannung Tension | Color Colour Farbe Couleur | Módulo LED LED unit LED Einheit Module LED | Largura Length Länge Longueur | Centro iluminado Illuminated center Schriftfeld beleuchtbar Avec eclaireage centre |
|---------|---|-------------------------------------|---|--|---|
| 667A.12 | 12V | ● | 2 | 1,20 m. | |
| 667A.24 | 24V | ● | 2 | 1,20 m. | |
| 667.00 | 12/24V | ● | 2 | 1,20 m. | |

(E)

■ Aplicación / ■ Application / ■ Anwendung / ■ Application



LED



| REF. | Tensión Voltage Spannung Tension | Color Colour Farbe Couleur | Módulo LED LED unit LED Einheit Module LED | Largura Length Länge Longueur | Centro iluminado Illuminated center Schriftfeld beleuchtbar Avec eclaireage centre |
|---------|---|-------------------------------------|---|--|---|
| 668A.12 | 12V | ● | 2 | 1,50 m. | |
| 668A.24 | 24V | ● | 2 | 1,50 m. | |
| 668.00 | 12/24V | ● | 2 | 1,50 m. | |

(E)

■ Aplicación / ■ Application / ■ Anwendung / ■ Application



LED



| REF. | Tensión Voltage Spannung Tension | Color Colour Farbe Couleur | Módulo LED LED unit LED Einheit Module LED | Largura Length Länge Longueur | Centro iluminado Illuminated center Schriftfeld beleuchtbar Avec eclaireage centre |
|---------|---|-------------------------------------|---|--|---|
| 669A.12 | 12V | ● | 4 | 1,50 m. | |
| 669A.24 | 24V | ● | 4 | 1,50 m. | |
| 669.00 | 12/24V | ● | 4 | 1,50 m. | |

(E)

Destellantes + Rotativos | Politz Kennleuchten + Rundumkennleuchten
Xenon Beacons + Rotating Beacons | Feu à Eclats + Gyrophares

■ Aplicación / ■ Application / ■ Anwendung / ■ Application



| REF. | V |
|--------|-----|
| 613.12 | 12V |
| 613.24 | 24V |

- Fijación tornillos
- Fixation crews
- Befestigungsschrauben
- Fixation vis



■ Aplicación / ■ Application / ■ Anwendung / ■ Application



| REF. | V |
|--------|-----|
| 614.12 | 12V |
| 614.24 | 24V |

- Magnético / ■ Magnetic / ■ Magnet / ■ Magnétique

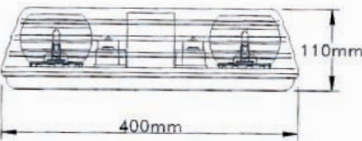

■ Aplicación / ■ Application / ■ Anwendung / ■ Application



| REF. | V |
|--------|----------|
| 661.00 | 10 - 48V |

- Fijación tornillos
- Fixation crews
- Befestigungsschrauben
- Fixation vis

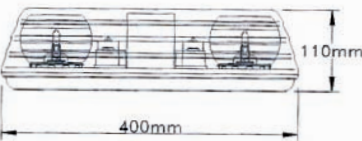

■ Aplicación / ■ Application / ■ Anwendung / ■ Application



| REF. | V |
|--------|----------|
| 659.00 | 10 - 48V |

- Magnético / ■ Magnetic / ■ Magnet / ■ Magnétique

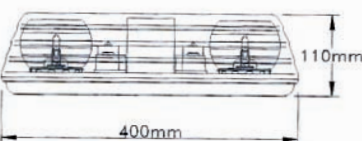

Cámaras Marcha Atrás
Reverse Camera Kit
Rückfahrkamera
Camera de Recul



Because
There's a world
behind

Cámaras Marcha Atrás | Rückfahrkamera | Reverse Camera Kit | Camera de Recul

■ Aplicación / ■ Application / ■ Anwendung / ■ Application



REF.
5952.00

■ Aplicación / ■ Application / ■ Anwendung / ■ Application



REF.
5953.00

■ Aplicación / ■ Application / ■ Anwendung / ■ Application



REF.
5954.00

■ Accesorios / ■ Accessories / ■ Zubehör / ■ Accessoires

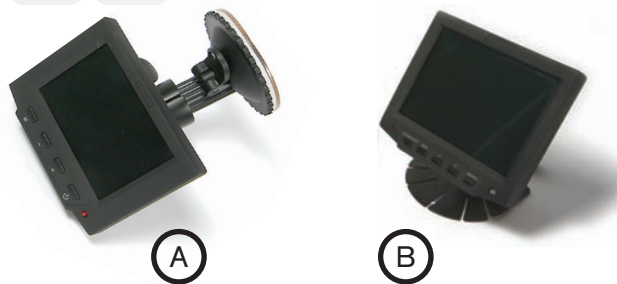

| REF. | | |
|---------|---|------|
| 5955.00 | A | 3,6" |
| 5956.00 | B | 5,6" |

(A)

(B)

Cámaras Marcha Atrás

Reverse Camera Kit

Rückfahrkamera

Camera de Recul

■ Accesorios / ■ Accesorios / ■ Zubehör / ■ Accessoires



- Color / Vision nocturna blanco y negro
- Colour / White & black nocturnal vision
- Farbe / Schwarz-Weiss Nachtsicht
- Couleur / Vision nocturne blanche et noire



REF.

5957.00

IP68

■ Accesorios / ■ Accesorios / ■ Zubehör / ■ Accessoires



- Color / Vision nocturna blanco y negro
- Colour / White & black nocturnal vision
- Farbe / Schwarz-Weiss Nachtsicht
- Couleur / Vision nocturne blanche et noire



REF.

5958.00

IP68

■ Accesorios / ■ Accesorios / ■ Zubehör / ■ Accessoires



- Color / Vision nocturna blanco y negro
- Colour / White & black nocturnal vision
- Farbe / Schwarz-Weiss Nachtsicht
- Couleur / Vision nocturne blanche et noire



REF.

5959.00

IP68

■ Accesorios / ■ Accesorios / ■ Zubehör / ■ Accessoires



- Color / Vision nocturna blanco y negro
- Colour / White & black nocturnal vision
- Farbe / Schwarz-Weiss Nachtsicht
- Couleur / Vision nocturne blanche et noire



REF.

5960.00

IP67

Cámaras Marcha Atrás Reverse Camera Kit

Rückfahrkamera Camera de Recul

■ Accesorios / ■ Accesories / ■ Zubehör / ■ Accessoires



| REF. | ■ Cable ■ Cable ■ Kabel ■ Câble |
|------|--|
|------|--|

| | |
|---------|-------|
| 5962.05 | 5 m. |
| 5962.10 | 10 m. |
| 5962.15 | 15 m. |
| 5962.20 | 20 m. |
| 5962.30 | 30 m. |



■ Aplicación / ■ Application / ■ Anwendung / ■ Application



- Sensor aparcamiento inalámbrico
- Wireless parking sensor
- Kabellose Einparkhilfe
- Capteur stationnement sans fil

REF.

5961.00

Accesorios
Accessories
Zubehör
Accessoires

Are you really
ready?
to drive

Accesorios
Accessories

Zubehör
Accessoires

■ Accesorios / ■ Accessories / ■ Zubehör / ■ Accessoires



UNIVERSAL

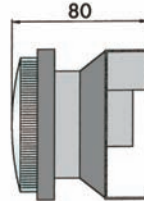
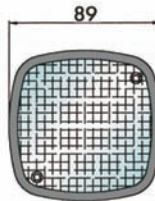

| REF. | ■ Conector ■ Connector ■ Buchse ■ Connecteur | ■ Pinzas ■ Tweezers ■ Greifer ■ Pince | 12V 21W | 3011.11 | ■ Luz ■ Light ■ Lichtraum ■ Feu |
|--------|---|--|---------|---------|--|
| 950.00 | ● | | ● | | A |
| 951.00 | | ● | ● | | A |

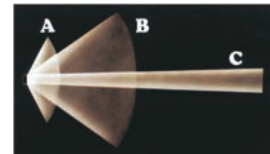

■ Accesorios / ■ Accessories / ■ Zubehör / ■ Accessoires



UNIVERSAL

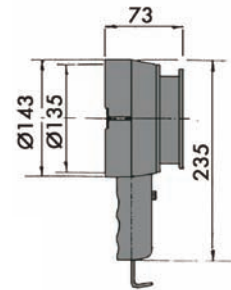

| REF. | 12V 55W H3 | 3011.11 | ■ Luz ■ Light ■ Lichtraum ■ Feu |
|--------|------------|---------|--|
| 961.00 | ● | | C |
| 962.00 | ● | | B |

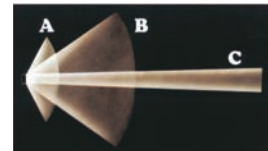

■ Accesorios / ■ Accessories / ■ Zubehör / ■ Accessoires



UNIVERSAL



| REF. | 12V 21W | 3011.11 |
|--------|---------|---------|
| 822.00 | ● | |

■ Accesorios / ■ Accessories / ■ Zubehör / ■ Accessoires



| REF. | ■ Carga ■ Load ■ Laden ■ Charge | ■ Clase ■ Type ■ Typ ■ Categorie |
|-------|--|---|
| 30.01 | 1 KG. | 5A - 34B - 6 |
| 30.02 | 2KG | 13A - 89B - C |



■ Accesorios / ■ Accessories / ■ Zubehör / ■ Accessoires

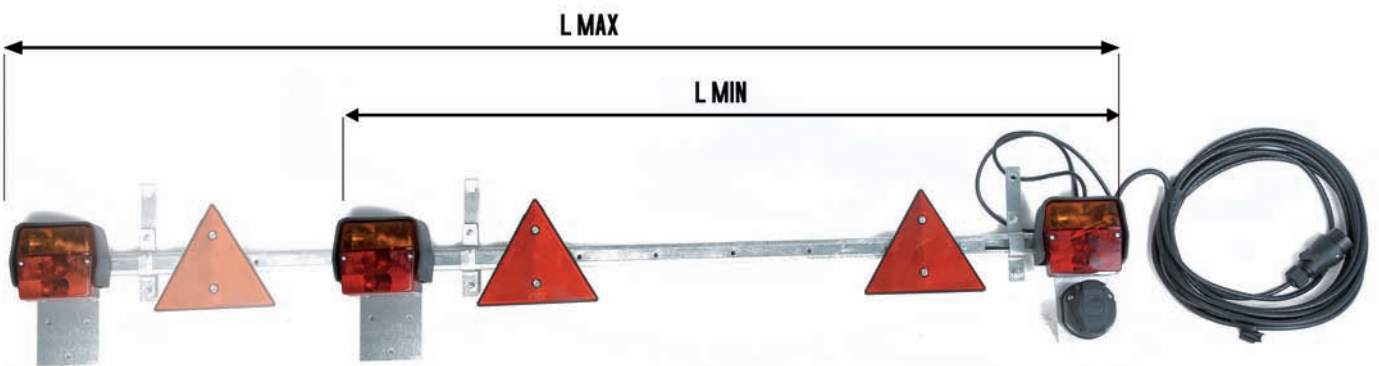

| REF. | ■ L MIN. ■ L MIN. ■ L MIN. ■ L MIN. | ■ L MAX. ■ L MAX. ■ L MAX. ■ L MAX. |
|--------|--|--|
| 780.00 | 160 | 210 |

Lámparas
Lamps
Glühlampen
Lampes

Creating
light

light



Lámparas | Glühlampen Lamps | Lampes

■ LÁMPARAS HALÓGENAS ■ HALOGEN LAMPS ■ HALOGEN LAMPEN ■ LAMPES HALOGÈNES

| E.C.E. R37 | REF. | Volt. | Wat. |
|------------|-----------|-------|---------|
| H1 | 5401.12 | 12V | 55W |
| H1 | 5401R.12* | 12V | 100W |
| H1 | 5401.24 | 24V | 70W |
| H3 | 5403.12 | 12V | 55W |
| H3 | 5403R.12* | 12V | 100W |
| H3 | 5403.24 | 24V | 70W |
| H4 | 5404.12 | 12V | 60/55W |
| H4 | 5404R.12* | 12V | 100/90W |
| H4 | 5404.24 | 24V | 75/70W |
| H7 | 5407.12 | 12V | 55W |
| H7 | 5407R.12* | 12V | 100W |
| H7 | 5407.24 | 24V | 70W |
| HB3 | 5408.12 | 12V | 60W |
| HB4 | 5409.12 | 12V | 51W |

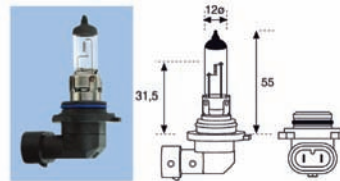
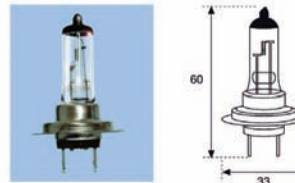
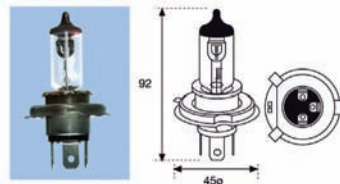
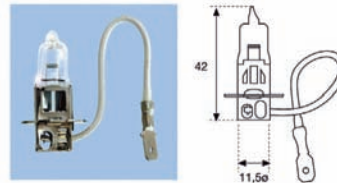
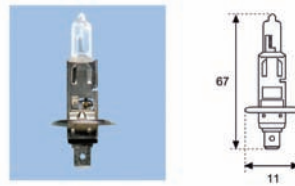

- (*) ■ Lámparas no homologadas. Uso en rallies.
 ■ Without EC approval. Only for rally.
 ■ Lampen ohne E-zulassung. Nur für rennsbahn/rally.
 ■ Lampes non homologuées. Uniquement pour rally et circuits.

■ LÁMPARAS XENON ■ XENON BULBS ■ XENON LAMPEN ■ LAMPES XÉNON

| E.C.E. R37 | REF. | Volt. | Wat. |
|------------|----------|-------|------|
| D2S | 541 7.00 | 85V | 35W |
| D2R | 5418.00 | 85V | 35W |

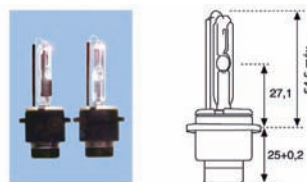

Lámparas | Glühlampen Lamps | Lampes

- LÁMPARAS AUXILIARES
- AUXILIARY LAMPS
- GEMEINDE LAMPEN
- LAMPES AUXILIAIRES



| E.C.E. R37 | REF. | Volt. | Wat. |
|---------------|----------|-------|--------|
| R2 | 5400.12 | 12V | 45/40W |
| R2 | 5400.24 | 24V | 55/50W |
| P21W | 5421.12 | 12V | 21W |
| P21W | 5421.24 | 24V | 21W |
| PY21W | 5421A.12 | 12V | 21W |
| PY21W | 5421A.24 | 24V | 21W |
| P21/5W | 5422.12 | 12V | 21/5W |
| P21/5W | 5422.24 | 24V | 21/5W |
| R5W | 5405.12 | 12V | 5W |
| R5W | 5405.24 | 24V | 5W |
| R10W | 5410.12 | 12V | 10W |
| R10W | 5410.24 | 24V | 10W |
| C5W | 5416.12 | 12V | 5W |
| C5W | 5416.24 | 24V | 5W |
| T4W | 5414.12 | 12V | 4W |
| T4W | 5414.24 | 24V | 4W |
| | 5412.12 | 12V | 1,2W |
| | 5412.24 | 24V | 1,2W |
| W3W | 5413.12 | 12V | 3W |
| W3W | 5413.24 | 24V | 3W |
| W5W | 5415.12 | 12V | 5W |
| W5W | 5415.24 | 24V | 5W |

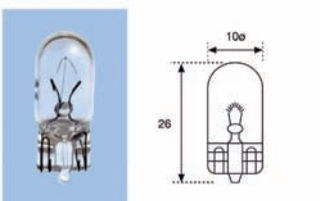
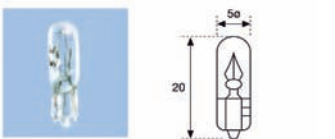
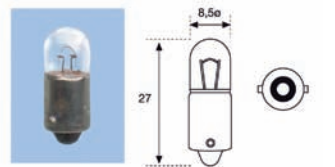
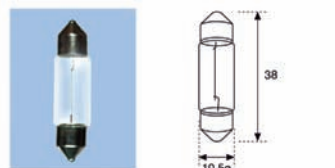
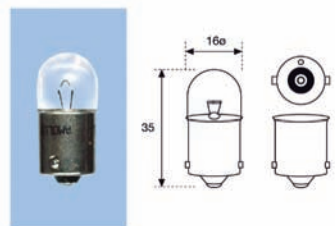
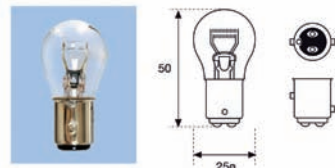
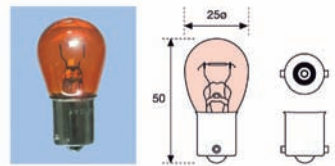
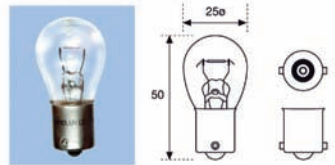
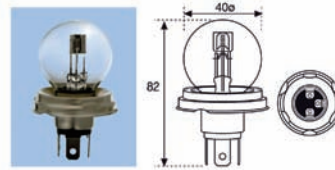

E

Lámparas | Glühlampen

Lamps | Lampes

- ESTUCHES DE CAMIÓN
- SPARE KITS 24V FOR TRUCKS
- LAMPEN KASTEN 24V FÜR LKW
- COFFRET DE SECOURS 24V CAMIONS







| | Ref. | Volt. | Faro | Stop (1f) | Stop (2f) | Piloto | Plafón | Control | Fusibles |
|-----------|---------|-------|------------|------------|------------|------------|------------|------------|----------|
| H4 | 5474.24 | 24V | 5404.24(2) | 5421.24(4) | 5422.24(2) | 5405.24(2) | 5416.24(2) | 5414.24(4) | 10 |
| H7 | 5477.24 | 24V | 5407.24(2) | 5421.24(4) | 5422.24(2) | 5405.24(2) | 5416.24(2) | 5414.24(4) | 10 |

Mod. Emb. 1/50

E

- ESTUCHES DE REPUESTO
- SPARE KITS
- LAMPEN KASTEN
- COFFRET DE SECOURS



| | Ref. | Volt. | Faro | Stop (1f) | Stop (2f) | Piloto | Control |
|---------------------------------|----------|---|---------|-----------|-----------|---------|---------|
| FEU ASYMETRIC 5 Lamps | 5450.12 | 12V | 5400.12 | 5421.12 | 5422.12 | 5405.12 | 5415.12 |
| | 5450.24 | 24V | 5400.24 | 5421.24 | 5422.24 | 5405.24 | 5415.24 |
| H1 5 Lamps | 5451.12 | 12V | 5401.12 | 5421.12 | 5422.12 | 5405.12 | 5415.12 |
| | 5451A.12 | 12V  | 5401.12 | 5421A.12 | 5422.12 | 5405.12 | 5415.12 |
| | 5451.24 | 24V | 5401.24 | 5421.24 | 5422.24 | 5405.24 | 5415.24 |
| H4 5 Lamps | 5454.12 | 12V | 5404.12 | 5421.12 | 5422.12 | 5405.12 | 5415.12 |
| | 5454A.12 | 12V  | 5404.12 | 5421A.12 | 5422.12 | 5405.12 | 5415.12 |
| | 5454.24 | 24V | 5404.24 | 5421.24 | 5422.24 | 5405.24 | 5415.24 |
| H7 5 Lamps | 5457.12 | 12V | 5407.12 | 5421.12 | 5422.12 | 5405.12 | 5415.12 |
| | 5457A.12 | 12V  | 5407.12 | 5421A.12 | 5422.12 | 5405.12 | 5415.12 |
| | 5457.24 | 24V | 5407.24 | 5421.24 | 5422.24 | 5405.24 | 5415.24 |
| H7/H1 6 Lamps | 5467.12 | 12V | 5407.12 | 5421.12 | 5422.12 | 5405.12 | 5415.12 |
| | | | 5401.12 | | | | |
| | 5467A.12 | 12V  | 5407.12 | 5421A.12 | 5422.12 | 5405.12 | 5415.12 |
| | | | 5401.12 | | | | |
| HB4 5 Lamps | 5459.12 | 12V | 5409.12 | 5421.12 | 5422.12 | 5405.12 | 5415.12 |
| HB3 5 Lamps | 5458.12 | 12V | 5408.12 | 5421.12 | 5422.12 | 5405.12 | 5415.12 |

Mod. Emb. 1/50

E



CERTIFICATE OF APPROVAL

This is to certify that the Quality Management System of:

RINDER INDUSTRIAL, S.A.
Gernika, Bizkaia
Spain

has been approved by Lloyd's Register Quality Assurance to the following Quality Management System Standards:

ISO 9001:2000

The Quality Management System is applicable to:

Design, manufacturing and commercialization of lighting devices for the automotive industry.

This certificate is valid only in association with the certificate schedule bearing the same number on which the locations applicable to this approval are listed.

Approval Certificate No: SGI 1205306 Original Approval: 19 September 1996
Current Certificate: 19 May 2008
Certificate Expiry: 18 May 2011

Issued by: LRQA, Ltd. Operaciones España



This document is subject to the provision on the reverse
71 Fenchurch Street, London EC3A 4BS United Kingdom. Registration number 1879370
This approval is carried out in accordance with the LRQA assessment and certification procedures, and monitored by LRQA.
The use of the UKAS Accreditation Mark indicates Accreditation in respect of the activities outlined covered by the Accreditation Certificate Number 001



CERTIFICATE OF APPROVAL

This is to certify that the Quality Management System of:

RINDER INDUSTRIAL, S.A.
Carlos Gangoiti, 71
48300 Gernika, Bizkaia
Spain

has been approved by Lloyd's Register Quality Assurance, Coventry, West Midlands, UK, to the following Quality Management System Standard:

ISO/TS 16949:2002

The Quality Management System is applicable to:

Design and manufacturing of lighting devices for the automotive industry.

This certificate is valid only in association with the certificate schedule bearing the same number on which the locations applicable to this approval are listed.

Approval Certificate No: SGI 1205306 Original ISO/TS 16949 Approval: 16 June 2005
Current Certificate: 19 May 2008
Certificate Expiry: 18 May 2011

Issued by: LRQA, Ltd. Operaciones España



IATF Certificate No: 0067626

This document is subject to the provision on the reverse
71 Fenchurch Street, London EC3A 4BS United Kingdom. Registration number 1879370
This approval is carried out in accordance with the LRQA assessment and certification procedures, and monitored by LRQA.



CERTIFICADO DE APROBACIÓN

Certificamos que el Sistema de Gestión de Calidad de:

RINDER INDUSTRIAL, S.A.
Gernika, Bizkaia
España

ha sido aprobado por Lloyd's Register Quality Assurance de acuerdo con las siguientes Normas de Sistemas de Gestión de Calidad:

ISO 9001:2000

El Sistema de Gestión de Calidad es aplicable a:

Diseño, fabricación y comercialización de dispositivos de iluminación para automoción.

Este certificado es válido sólo cuando va acompañado del anexo al certificado con el mismo número, en el que se detallan las delegaciones a las que se aplica esta aprobación.

Aprobación Certificado No: SGI 1205306 Aprobación Original: 19 de Septiembre 1996
Certificado en Vigor: 19 de Mayo 2008
Caducidad del Certificado: 18 de Mayo 2011

Emitido por: LRQA, Ltd. Operaciones España



Este documento está sujeto a los términos y condiciones que aparecen al dorso
71 Fenchurch Street, London EC3A 4BS United Kingdom. Registration number 1879370
Esta aprobación está condicionada a que la compañía mantenga el sistema de acuerdo con las normas establecidas, lo que será verificado por LRQA.
El uso de la Marca de Acreditación (UKAS) indica Acreditación con respecto a aquellas actividades cubiertas por el Certificado de Acreditación 001



CERTIFICADO DE APROBACIÓN

Certificamos que el Sistema de Gestión de Calidad de:

RINDER INDUSTRIAL, S.A.
Carlos Gangoiti, 71
48300 Gernika, Bizkaia
España

ha sido aprobado por Lloyd's Register Quality Assurance, Coventry, West Midlands, Reino Unido, de acuerdo con la siguiente Norma de Sistema de Gestión de Calidad:

ISO/TS 16949:2002

El Sistema de Gestión de Calidad es aplicable a:

Diseño y fabricación de dispositivos de iluminación para automoción.

Este certificado es válido sólo cuando va acompañado del anexo al certificado con el mismo número, en el que se detallan las delegaciones a las que se aplica esta aprobación.

Aprobación Certificado No: SGI 1205306 Aprobación Original ISO/TS 16949: 16 de Junio 2005
Certificado en Vigor: 19 de Mayo 2008
Caducidad del Certificado: 18 de Mayo 2011

Emitido por: LRQA, Ltd. Operaciones España



IATF Certificate No: 0067626

Este documento está sujeto a los términos y condiciones que aparecen al dorso
71 Fenchurch Street, London EC3A 4BS United Kingdom. Registration number 1879370
Esta aprobación está condicionada a que la compañía mantenga el sistema de acuerdo con las normas establecidas, lo que será verificado por LRQA.

rinder

Un gran grupo al servicio de una industria de automoción global
An important group at a global automotive industry's service
Eine Gruppe zur Verfügung der gesamten Automobilindustrie
Un grand group au service de l'industrie de l'automobile global



Mercedes-Benz



JAGUAR



HONDA



YAMAHA



SUZUKI



PEUGEOT



GASGAS



NEW HOLLAND



NISSAN



Benelli



GILERA

Kubota



BAJAJ

Distinctly Ahead



IRIZAR



TVS



MCH
MOTORCYCLES

IVECO



Malaguti
100% INNOVATION



JOHN DEERE



CAGIVA

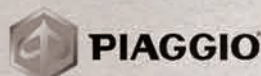

PIAGGIO



DERBI



TRIUMPH



TATA



MASSEY FERGUSON

© 2011 Rinder

DAELIM

italjet

CASE



BENETTON

MBK
A NEW WORLD





Rinder Industrial, S.A.

Address

Paseo Carlos Gangoiti, 71
48300 Gemika - Spain

Tel: +34 946270030
Fax: +34 946270238

e-mail:

rinder@rinder.com

Pedidos Nacionales / National Orders

Tel: +34 946270241

Pedidos Exportación / Export Orders

Tel: +34 946270234

e-mail:

exportservice@rinder.com

GPS Coordinates

Longitude: 43°19'29.62"N
Latitude: 2°40'42.28"W

www.rinder.es

Corporación Rinder, S.L.

Address

Parque tecnológico de Bizkaia
Pabellón 105, 2ª Planta
48170 Zamudio - Spain

Tel: +34 9443178 71
Fax: +34 902998439

Videoconference

IP: vc.rindercorp.com
RDSI/ISDN: +34 944317845

e-mail:

rindercorp@rindercorp.com

GPS Coordinates

Longitude: 43°17'29.17"N
Latitude: 2°51'31.63"W

www.rinder.es

Light & Systems Technical Center, S.L.

Address

Parque tecnológico de Bizkaia
Pabellón 105, 2ª Planta
48170 Zamudio - Spain

Tel: +34 944317930
Fax: +34 902995695

Videoconference

IP: vc.rindercorp.com
RDSI/ISDN: +34 944317845

e-mail:

lightsystems@lightsystems.es

GPS Coordinates

Longitude: 43°17'29.17"N
Latitude: 2°51'31.63"W

www.rinder.es

Rinder India Pvt. Ltd. (Delhi)

Address

Plot no 12-13, Sector -16,
IE Bahadurgarh - 124507
India

Tel: +91 01276326878
Fax: +91 01276244964
Cell: +91 9896551238

e-mail:

schaudhary@rinder.in

www.rinder.es

Rinder India Pvt. Ltd. (Chakan)

Address

Gat No 148, Mhalunge Ingale,
Off Chakan Talegaon Road
Tal -Khed, Dist Pune-410501
India

Tel: +91 02030616100200
Fax: +91 02030616161/62

Videoconference

IP: vc.rinder.in

e-mail:

marketing@rinder.in

GPS Coordinates

Longitude: 18°31'13.69"N
Latitude: 73°51'23.84"E

www.rinder.es

Lampsys Light Systems, S.L.

Address

Parque Tecnológico de Álava
C/ Marie Curie Nº 1
01510 Miñano
Vitoria-Gasteiz (Álava) - Spain

e-mail:

lampsys@lampsys.es

GPS Coordinates

Longitude: 42°54'26.17"N
Latitude: 2°40'6.23"W

www.rinder.es

Rinder India Pvt. Ltd. (Pimpri)

Address

74/74A
F-II Block
MIDC - Pimpri - 411018
India

Tel: +91 02066114461
/27472508

e-mail:

marketing@rinder.in

www.rinder.es

Distribuido Por: / Distributed By: / Verteilet Von: / Distribué Par:

