

IGNITION COILS
BOBINAS DE ENCENDIDO
BOBINE D'ALLUMAGE



Ref. FAE

Suitable / Reemplaza:

Maker Reference
Fabricante Referencia
Constructeur Référence



A

B

C

D

MAKER	Year		
Model	Year		
FABRICANTE	Año		
Modelo	Año		
CONSTRUCTEUR	Année		
Modèle	Année		

A Low tension connection
 Conexión de baja tensión
 Connection basse tension

B Secondary resistance
 Resistencia del secundario
 Resistance secondaire

C Primary resistance
 Resistencia del primario
 Resistance primaire

D High voltage connection
 Conexión de alta tensión
 Connection haute tension

Ref. 80219

Suitable / Reemplaza:

Volkswagen 701 905 104
 701 905 104 A
 867 905 105 A



+ OUT TACHI



IN GND GND

3,3 K Ω

Ø 4



AUDI	Year	VOLKSWAGEN	Year
80 2.0 E, Avant, quattro	1992-96	Golf II 1.3 Kat	1986-92
SEAT			
Cordoba 1.8 i 16V	1993-96	Passat 1.6, Variant	1988-88
Ibiza II 1.3 i	1993-99	Passat 1.8, Variant	1988-96
Ibiza II 1.8 i	1993-99	Passat 2.0 16V, Variant	1994-96
Ibiza II 2.0 i	1993-99	Passat 2.0, Syncro, Variant	1990-96
Toledo I 1.6 i	1991-93	Polo 1.0 Classic	1985-94
Toledo I 1.8 i	1993-96	Polo 1.0 Kat, Coupe	1989-94
Toledo I 2.0 i	1991-99	Polo 1.0, Coupe	1985-92
Toledo I 2.0 i 16V	1993-99	Polo 1.3 Furgón	1992-94
		Polo 1.3 Kat Classic	1987-94
		Polo 1.3 Kat, Coupe	1987-94
		Transporter IV 1.8	1990-92
		Transporter IV 2.0	1990-03
		Vento 1.6	1992-98

SYMBOLS / SÍMBOLOS / SYMBOLES

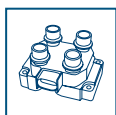

IGNITION COILS
 BOBINAS DE ENCENDIDO
 BOBINE D'ALLUMAGE

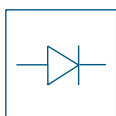

SYMBOL OF DIODE
 SÍMBOLO DEL DIODO
 SYMBOL DU DIODE



CONNECTOR DIN
 CONECTOR DIN
 CONEXION DIN



CONNECTOR SAE
 CONECTOR SAE
 CONEXION SAE



CONECTOR Ø 7
 CONECTOR Ø 7
 CONEXION Ø 7

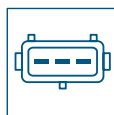

TYPE OF CONNECTION
 TIPO DE CONEXIÓN
 TYPE DE CONNEXION



INFORMATION
 INFORMACIÓN
 INFORMATION



RESISTANCE
 RESISTENCIA
 RESISTANCE



CONNECTOR Ø 4
 CONECTOR Ø 4
 CONEXION Ø 4

Vehicles models for general information only. Not to be used as a detailed applications guide. Manufacturer's names and original numbers are quoted for reference purposes only.
 Los modelos de vehículos se dan como información general. No se deben utilizar como guía detallada de aplicaciones. Los nombres y referencias de los fabricantes de vehículos sirven únicamente para ayudar a encontrar más rápidamente nuestros productos.

Les modèles de véhicules sont présentés à titre d'information générale uniquement. Le document ne constitue pas un guide pratique et ne doit pas être utilisé comme tel. Le noms et numéros des fabricants son mentionnés seulement pour faciliter la recherche de nos références.

For further applications see

Para más aplicaciones consulte también

Pour déterminer les autres affectations veuillez vous référer à



Ref. 80201

Suitable / Reemplaza:

Seat	036 905 100 D 036 905 715 036 905 715 A 036 905 715 C
Skoda	036 905 715 036 905 715 A 036 905 715 C 036 905 715 E
Volkswagen	036 905 100 A 036 905 100 B 036 905 100 C 036 905 100 D 036 905 715 036 905 715 A 036 905 715 F

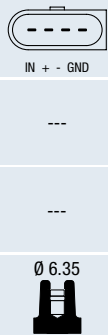
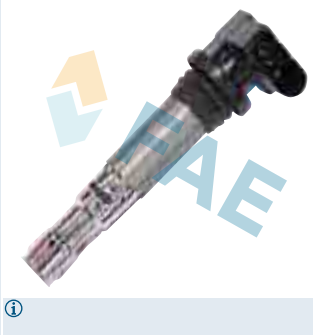

VOLKSWAGEN

Bora 1.4 16V	2000-05
Bora 1.4 16V Kombi	2001-05
Bora 1.6 16V, Kombi	2000-05
Bora 1.6 FSI, Kombi	2002-05
Caddy III 1.4	2004-06
Caddy III 1.4 16V	2006-10
Eos 1.4 TSI	2007 ->
Eos 1.6 FSI	2006-08
Golf IV 1.4 16V	1997-05
Golf IV 1.4 16V, Variant	1999-06
Golf IV 1.6 16V, Variant	2000-05
Golf IV 1.6 FSI, Variant	2002-05
Golf Plus 1.4 16V	2005 ->
Golf Plus 1.4 FSI	2005 ->
Golf Plus 1.4 TSI	2006-08
Golf Plus 1.6 FSI	2005-08
Golf V 1.4 16V	2003-06
Golf V 1.4 16V, Variant	2006-08
Golf V 1.4 FSI	2003-06
Golf V 1.4 TSI Variant	2008 ->
Golf V 1.4 TSI, Variant	2005-08
Golf V 1.6 FSI	2003-08
Golf VI 1.4	2008 ->
Golf VI 1.4 TSI, Variant	2008 ->
Golf VI 1.4 Variant	2009 ->
Jetta III 1.4 TSI	2006-10
Jetta III 1.6 FSI	2005-10
Lupo 1.4 16V	1998-05
New Beetle 1.4 Cabrio	2001 ->
Passat 1.4 TSI EcoFuel	2009-10
Passat 1.4 TSI, Variant	2007-10
Passat 1.6 FSI, Variant	2005-08
Polo 1.2	2009 ->
Polo 1.2 12V	2001-07
Polo 1.4	2009 ->
Polo 1.4 16V	2001-08
Polo 1.4 FSI	2002-06
Polo 1.4 GTI	2010 ->
Polo 1.4 Sedan	2003 ->
Polo 1.6 16V	2006 ->
Scirocco 1.4 TSI	2008 ->
Sharan 1.4 TSI	2010 ->
Tiguan 1.4 TSI	2010 ->
Tiguan 1.4 TSI, 4motion	2007 ->
Touran 1.4 FSI	2006 ->
Touran 1.4 TSI	2006 ->
Touran 1.4 TSI EcoFuel	2009 ->
Touran 1.6 FSI	2003-07

AUDI		
A1 1.4 TFSI	2010 ->	
A2 1.4	2000-05	
A2 1.6 FSI	2002-05	
A3 1.4 TFSI, Sportback	2007 ->	
A3 1.6 FSI	2003 ->	
A3 1.6 FSI Sportback	2004 ->	
SEAT		
Alhambra 1.4 TSI	2010 ->	
Altea 1.4 16V	2006 ->	
Altea 1.4 TSI	2007 ->	
Altea XL 1.4 16V	2006 ->	
Altea XL 1.4 TSI	2007 ->	
Cordoba 1.2	2002-06	
Cordoba 1.2 12V	2006-09	
Cordoba 1.4 16V	2002-07	
Cordoba 1.6 16V	2006-09	
Ibiza IV 1.2	2002-06	
Ibiza IV 1.2 12V	2006-09	
Ibiza IV 1.4 16V	2002-07	
Ibiza IV 1.6 16V	2006-09	
Ibiza V 1.2	2008 ->	
Ibiza V 1.2 Sportcoupe	2008 ->	
Ibiza V 1.2 ST	2010 ->	
Ibiza V 1.4	2008 ->	
Ibiza V 1.4 Sportcoupe	2008 ->	
Ibiza V 1.4 ST	2010 ->	
Ibiza V 1.4 TSI	2009 ->	
Ibiza V 1.4 TSI Sportcoupe	2009 ->	
Ibiza V 1.6	2008 ->	
Ibiza V 1.6 Sportcoupe	2008 ->	
Leon 1.4 16V	1999-06	
Leon 1.4 TSI	2007 ->	
Leon 1.6 16V	2000-06	
Toledo II 1.6 16V	2000-06	

SKODA		
Fabia 1.2	2007 ->	
Fabia 1.2 Combi	2007 ->	
Fabia 1.2, Combi, Praktik, Sedan	2003-07	
Fabia 1.4	2007 ->	
Fabia 1.4 16V, Combi, Sedan	1999-07	
Fabia 1.4 Combi	2007 ->	
Fabia 1.4 TSI	2010 ->	
Fabia 1.4 TSI Combi	2010 ->	
Fabia 1.6	2007 ->	
Fabia 1.6 Combi	2007 ->	
Octavia 1.4	2004-06	
Octavia 1.4 16V, Combi	2000-10	
Octavia 1.4 TSI, Combi	2008 ->	
Octavia 1.4, Combi	2004 ->	
Octavia 1.6 FSI, Combi	2004-08	
Roomster 1.2	2006-07	
Roomster 1.4	2006 ->	
Roomster 1.6	2006 ->	
Roomster Praktik 1.2	2007 ->	
Roomster Praktik 1.4	2007 ->	
Superb 1.4 TSI	2008 ->	
Superb 1.4 TSI Kombi	2009 ->	
Yeti 1.4 TSI	2010 ->	

Ref. 80202

Suitable / Reemplaza:

Seat	06A 905 115 A 06A 905 115 D 06B 905 115 G 06B 905 115 H
Skoda	06A 905 115 A 06A 905 115 D 06B 905 115 G 06B 905 115 H
Volkswagen	06A 905 115 06A 905 115 A 06A 905 115 B 06A 905 115 C 06A 905 115 D 06B 905 115 D

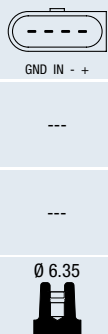

VOLKSWAGEN

Bora 1.8 T	2000-05
Bora 1.8 T Kombi	2000-05
Bora 1.8 T, Kombi	2002-05
Golf IV 1.8 T	1997-05
Golf IV 1.8 T GTI	2001-05
Golf IV 1.8 T, Variant	2000-06
New Beetle 1.8 T	1999 ->
New Beetle 1.8 T Cabrio	2003-10
Passat 1.8 T 20V	2000-05
Passat 1.8 T 20V Variant	2000-05
Passat 2.0, Variant	2001-05
Polo 1.8 GTI	2005 ->
Polo 1.8 GTI Cup Edition	2006 ->

AUDI		
A3 1.8 T	1996 ->	
A3 1.8 T quattro	1996 ->	
A3 S3 quattro	1999 ->	
A4 1.8 T	2002-04	
A4 1.8 T Cabrio, quattro	2002-09	
A4 1.8 T, Avant, quattro	1995-00	
A4 2.0, Avant, Cabrio	2004-08	
A6 1.8 T	1997-05	
A6 1.8 T, Avant, quattro	1997-05	
A6 2.7 T quattro, Avant	2001-05	
Allroad 2.7 T quattro	2000-05	
TT 1.8 T	1998-06	
TT 1.8 T quattro	2005-06	
TT 1.8 T quattro, Roadster	1998-06	
TT 1.8 T Roadster	1999-06	
TT 1.8 T, Roadster, quattro	2001-06	

SEAT		
Cordoba 1.8 T 20V Cupra	2000-02	
Ibiza III 1.8 T 20V Cupra	2000-02	
Ibiza IV 1.8 T Cupra R	2004-08	
Ibiza IV 1.8 T FR	2003-08	
Leon 1.8 20V T	1999-06	
Leon 1.8 20V T 4	1999-06	
Leon 1.8 T Cupra R	2002-06	
Toledo II 1.8 20V T	2001-06	
SKODA		
Octavia 1.8 T 4x4, Combi	2001-06	
Octavia 1.8 T, Combi	1997-10	
Octavia RS 1.8 T, Combi	2001-06	
Superb 1.8 T	2002-08	



Ref. 80203

Suitable / Reemplaza:

G.M.	91159920 91159996
Nissan	22448-00Q0 A 22448-00Q0 B 22448-00Q0 C
Opel	4408283 4408389 4413233
Renault	77 00 107 177 77 00 113 357 77 00 113 357 A 77 00 875 000 82 00 154 186 82 00 154 186 A



0,65 Ω

10 KΩ

Ø 4



RENAULT Cont.		
Megane II 1.6 16V Sedan	2006 ->	
Megane II 1.6 Coupe-Cabrio	2003 ->	
Megane II 1.6 Flex-Fuel	2007 ->	
Megane II 1.6 Kobi	2003 ->	
Megane II 1.6 Sedan	2003 ->	
Megane II 2.0	2006 ->	
Megane II 2.0 16V	2002 ->	
Megane II 2.0 16V Turbo Coupe-Cabrio	2004 ->	
Megane II 2.0 Coupe-Cabrio	2003 ->	
Megane II 2.0 Kombi	2003 ->	
Megane II 2.0 Renault Sport	2004 ->	
Megane II 2.0 Sedan	2003 ->	
Megane III 1.6 16V	2008 ->	
Megane III 1.6 16V Bifuel	2008 ->	
Megane III 1.6 16V Bifuel Coupe	2008 ->	
Megane III 1.6 16V Bifuel Grandtour	2008 ->	
Megane III 1.6 16V Coupe	2008 ->	
Megane III 1.6 16V Grandtour	2009 ->	
Megane III 2.0 TCe	2008 ->	
Megane III 2.0 TCe Coupe	2008 ->	
Megane III 2.0 TCe Grandtour	2008 ->	
Modus 1.4	2004 ->	
Modus 1.6	2004 ->	
Scénic I 1.4 16V	1999-03	
Scénic I 1.6	2001-03	
Scénic I 1.6 16V	1999-03	
Scénic I 1.8 16V	2001-03	
Scénic I 2.0 16V	1999-03	
Scénic I 2.0 16V RX4	2000-03	
Scénic II 1.4	2003 ->	
Scénic II 1.6	2003 ->	
Scénic II 1.6 16V	2007 ->	
Scénic II 2.0	2003 ->	
Scénic II 2.0 16V Turbo	2004 ->	
Scénic III 1.6 16V	2009 ->	
Scénic III 1.6 E85	2009 ->	
Thalia 1.4 16V	2000 ->	
Trafic II 2.0	2001 ->	
Trafic II 2.0 16V	2006 ->	
Twingo 1.6 RS	2008 ->	
Vel Satis 2.0 16V Turbo	2002 ->	
Wind 1.6	2010 ->	
Vivaro 2.0 16V	2001 ->	

DACIA		RENAULT Cont.	
Duster 1.6 16V	2010 ->	Kangoo 1.6 16V, Express	2001 ->
Duster 1.6 16V 4x4	2010 ->	Kangoo 1.6 16V, Express, 4x4	2001 ->
Logan 1.6 16V	2006 ->	Kangoo 1.6 Be Bop	2009 ->
Logan 1.6 16V MCV	2007 ->	Laguna 1.6 16V, Grandtour	1997-01
Logan 1.6 16V MCV Flexifuel	2009 ->	Laguna 1.8 16V, Grandtour	1998-01
NISSAN		Laguna 2.0 16V Turbo Coupe	2008 ->
Kubistar 1.2	2003 ->	Laguna 2.0 16V, Grandtour	1999-01
Kubistar 1.6 16V	2003 ->	Laguna 2.0 GT	2008 ->
Primastar 2.0	2001 ->	Laguna II 1.6 16V, Grandtour	2001 ->
OPEL		Laguna II 1.8 16V	2001 ->
Vivaro 2.0 16V	2001 ->	Laguna II 1.8 16V Grandtour	2001 ->
Vivaro 2.0 Ecotec	2006 ->	Laguna II 1.8 16V, Grandtour	2001 ->
RENAULT		Laguna II 2.0 16V	2005 ->
Avantime 2.0 16V Turbo	2001-03	Laguna II 2.0 16V Grandtour	2005 ->
Clio 1.4 16V Grandtour	2010 ->	Laguna II 2.0 16V Turbo, Grandtour	2003 ->
Clio 1.6 16V Grandtour	2008 ->	Laguna II 2.0 16V, Grandtour	2002 ->
Clio II 1.4 16V	1999-00	Laguna III 1.6 16V	2007 ->
Clio II 1.6 16V	1998 ->	Laguna III 2.0 16V Turbo, Grandtour	2007 ->
Clio II 2.0 16V Sport	2000 ->	Laguna III 2.0 GT, Grandtour	2008 ->
Clio III 1.4 16V	2005 ->	Logan 1.6	2007 ->
Clio III 1.6 16V	2005 ->	Logan 1.6 Kombi	2007 ->
Clio III 1.6 16V GT	2009 ->	Megane CC 1.6 16V	2010 ->
Clio III 2.0 16V Sport	2006 ->	Megane CC 2.0 TCe	2010 ->
Espace III 2.0	2001-02	Megane I 1.4 16V	1999 ->
Espace III 2.0 16V	1998-02	Megane I 1.6 16V, Classic, Cabrio, Coach	1999 ->
Espace IV 2.0	2002 ->	Megane I 1.6 16V, Grandtour	1999 ->
Espace IV 2.0 Turbo	2002 ->	Megane I 1.8 16V, Classic, Grandtour	2001 ->
Grand Scénic II 1.6	2004 ->	Megane I 2.0 16V, Cabrio, Coach	2002 ->
Grand Scénic II 2.0	2004 ->	Megane II 1.4 16V, Kombi, Sedan	2002 ->
Grand Scénic III 1.6 16V	2009 ->	Megane II 1.4 16V, Sedan	2003 ->
Kangoo 1.6 16V	2008 ->	Megane II 1.4 Sedan	2003 ->
Kangoo 1.6 16V Express	2008 ->	Megane II 1.6 16V	2002 ->
Kangoo 1.6 16V Hi-Flex	2008 ->	Megane II 1.6 16V Coupe-Cabrio	2006 ->
Kangoo 1.6 16V LPG Express	2008 ->	Megane II 1.6 16V Kombi	2006 ->

Ref. 80204

Suitable / Reemplaza:

Renault	77 00 100 589
----------------	---------------



1,2 Ω

9 KΩ

Ø 4



RENAULT		
Clio II 1.4	1998-05	
Clio II 1.6	1998-05	
Kangoo 1.4	1997 ->	
Kangoo 1.4 Express	1997 ->	
Megane I 1.6 e Cabrio, Coach, Grandtour	1996-99	
Megane I 1.6 e, Classic	1996-99	
Megane I 1.6 i, Classic	1996-99	
Megane Scenic 1.6 e	1997-99	
Megane Scenic 1.6 i	1997-99	

Ref. 80205

Suitable / Reemplaza:

Renault	77 00 100 643
----------------	---------------



1,4 Ω

9,5 KΩ

Ø 4



RENAULT		
Clio II 1.4	1998-05	
Clio II 1.6	1998-05	
Kangoo 1.4	1997 ->	
Kangoo 1.4 Express	1997 ->	
Megane I 1.6 e Cabrio, Coach, Grandtour	1996-99	
Megane I 1.6 e, Classic	1996-99	
Megane I 1.6 i, Classic	1996-99	
Megane Scenic 1.6 e	1997-99	
Megane Scenic 1.6 i	1997-99	



Ref. 80206

Suitable / Reemplaza:

Nissan	22448-00QAD
Renault	82 00 025 256
	82 00 051 128
	82 00 084 401

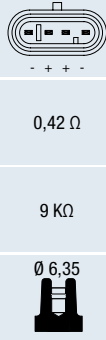

NISSAN		RENAULT	
Kubistar 1.2 16V	2006 ->	Clio II 1.2	2001-03
		Clio II 1.2 16V	2001 ->
		Kangoo 1.2 16V	2001 ->
		Kangoo 1.2 16V Express	2001 ->
		Kangoo 1.2, Express	1997 ->
		Thalia 1.2 16V	2002 ->
		Twingo 1.2 16V	2001 ->

Ref. 80207

Suitable / Reemplaza:

Citroën	96.074.054
	96.165.970
	96.228.897
Fiat	9607405480
	9622889780
Peugeot	5970.48
	5970.60
	5970.70

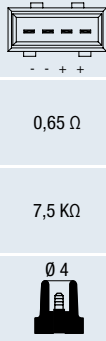

PEUGEOT			
106 II 1.0 i	1996 ->		
106 II 1.1 i	1996 ->		
106 II 1.4 i	1996 ->		
106 II 1.6 i	1996 ->		
205 I 1.1 CJ Cabrio	1989-94		
205 I 1.6 CJ Cabrio	1992-94		
205 II 1.1	1989-98		
205 II 1.4	1990-98		
205 II 1.6	1987-98		
205 II 1.6 Aut.	1990-98		
306 1.1	1993-01		
306 1.4	1993-01		
306 1.4 Break	1997-02		
306 1.4 SL	1994-01		
306 1.6 SR, Break, Cabrio	1993-00		
306 1.8 ST	1994-01		
306 1.8, Break, Cabrio	1993-01		
306 2.0 S16, Fastback	1993-01		
306 2.0 ST, Cabrio, Fastback	1993-01		
306 2.0, Break, Cabrio	1997-01		
309 II 1.6	1989-93		
405 I 1.6	1987-92		
405 I 1.6 Break	1988-92		
405 I 1.9	1987-93		
405 II 1.6 Break	1992-96		
405 II 1.6, Break	1992-95		
405 II 1.8, Break	1992-96		
405 II 2.0	1992-95		
405 II 2.0 4x4 Break	1992-95		
405 II 2.0 Break	1992-96		
405 II 2.0 MI-16	1992-95		
405 II 2.0 T 16 X4	1992-95		
405 II 2.0 X4	1992-95		
406 1.6	1995-04		
406 1.8	1997-04		
406 1.8, Break	1997-04		
406 2.0 16V, Break, Coupe	1995-04		
406 2.0 Turbo, Break	1996-04		
605 2.0	1989-99		
605 2.0 Turbo	1991-99		
806 1.8	1995-02		
806 2.0	1994-02		
806 2.0 Turbo	1994-02		
Boxer 2.0	2002 ->		
Boxer 2.0 i, 4x4	1994-02		
Expert 1.8	1996-00		
Partner 1.1	1996 ->		
Partner 1.1 Combispace	1996 ->		
Partner 1.4, Combispace	1996 ->		
Partner 1.8 Combispace	1997 ->		

CITROËN		CITROËN Cont.			
Berlingo 1.1 i	1996 ->	XM 2.0 i 16V, Break	1994-00		
Berlingo 1.4 i	1996 ->	XM 2.0 i Break	1991-94		
Berlingo 1.8 i, 4WD	1997 ->	XM 2.0 i Turbo, Break	1992-94		
BX 16	1982-92	XM 2.0 i, Break	1989-94		
BX 16 E, Break	1989-93	XM 2.0 Turbo	1994-00		
BX 16, Break	1982-88	XM 2.0 Turbo Break	1994-00		
BX 19	1986-89	Xsara 1.4 i, Break, Coupe	1997-05		
BX 19 Break	1988-94	Xsara 1.6 i, Break, Coupe	1997-00		
BX 19 Break, 4x4	1990-91	Xsara 1.8 i, Break, Coupe	1997-00		
BX 19 E 4x4	1989-93	ZX 1.4 i	1991-97		
BX 19 E, Break, 4x4	1988-93	ZX 1.4 i Break	1993-97		
BX 19 GTi	1986-93	ZX 1.6 i, Break	1991-97		
BX 19 Gti, Break, 4x4	1988-93	ZX 1.8 i, Break	1992-97		
BX 19 Kat Break	1986-94	ZX 1.9	1991-97		
BX 19, Break	1986-94	ZX 1.9 i	1991-97		
Evasion 1.8	1997-02	ZX 2.0	1994-97		
Evasion 2.0	1994-02	ZX 2.0 i	1992-97		
Evasion 2.0 Turbo C.T.	1994-02	ZX 2.0 i 16V	1992-94		
Jumper 2.0, 4x4	1994-02	FIAT			
Jumper 2.0, Bivalent	2002 ->	Ducato 2.0	1994-02		
Saxo 1.0 X	1996-98	Ducato 2.0 Bipower	2002 ->		
Saxo 1.1 X, SX	1996-03	Ducato 2.0 Panorama/Combinato	1994-02		
Saxo 1.4 VTS	1996-03	Ulysse 1.8	1997-02		
Saxo 1.6	1996-03	Ulysse 2.0	1994-02		
Saxo 1.6 VTL, VTR	1996-03	Ulysse 2.0 Turbo	1994-02		
Saxo 1.6 VTS	2000-03	INNOCENTI			
Xantia 1.6 i	1993-98	Elba 1.4 i.e.	1994-96		
Xantia 1.6 i SX	1998-01	Elba 1.6 i.e.	1994-96		
Xantia 1.8 i, Break	1993-98	LANCIA			
Xantia 2.0 i 16V	1993-98	Zeta 2.0 Turbo	1995-02		
Xantia 2.0 i 16V, Break	1995-98				
Xantia 2.0 i, Break	1993-98				
Xantia 2.0 Turbo, Break	1995-98				
XM 2.0 i	1989-94				



Ref. 80211

Suitable / Reemplaza:

Mercedes 000 150 02 80
000 158 70 03
000 158 71 03
000 158 75 03
Ssangyong 0001587503
Volkswagen 00A 905 105



0,4 Ω

6,5 KΩ

Ø 4



MERCEDES BENZ Cont.

E 200, T Kombi	1995-00
E 220, Cabrio, Coupe, T Kombi	1993-97
E 230, T Kombi	1995-97
E 280	1996-97
E 280 largo, T kombi	1993-95
E 280, T Kombi	1993-95
E 320	1995-97
E 320 Cabrio	1993-98
E 320, Coupe, T Kombi	1993-95
G 36 AMG	1995 ->
G 320	1994-97
ML 230	1998-05
S 280 (W140)	1993-98
S 300 SE 2.8 (W140)	1993-98
S 300 SE,SEL/S320 (W140)	1991-98
SL 280	1993-01
SL 320	1993-01
SLK 200	1996-00
SLK 200 Kompressor	1996-00
SLK 230 Kompressor	1996-00
Sprinter 2-t 214	1995-06
Sprinter 2-t 214 NGT	2000-06
Sprinter 2-t 314 NGT	2000-06
Sprinter 3-t 314	1995-06
Sprinter 3-t 314, 4x4	1995-06
Sprinter 4-t 414, 4x4	1996-06
V 200	1997-03
V 230	1996-03
Vito 113 2.0	1996-03
Vito 114 2.3	1996-03

PUCH

G 320	1994-97
G 36 AMG	1995 ->

SSANGYONG

Korando 2.0	1997 ->
Korando 2.3	1997 ->
Korando 2.3 Cabrio	1997 ->
Korando 3.2	1996 ->
Korando 3.2, Cabrio	1999 ->
Musso 2.0	1996 ->
Musso 2.3	1996 ->
Musso 3.2	1996 ->
Rexton 3.2	2002 ->

VOLKSWAGEN

LT 28-35 II 2.3	1996-06
LT 28-46 II 2.3	1996-06

DAEWOO

Korando 2.0 16V Cabrio	1999 ->
Korando 2.3, Cabrio	1999 ->
Korando 3.2 4x4	1999 ->
Musso 2.3	1999 ->
Musso 3.2 4x4	1999 ->
Rexton 3.2 V6	2002 ->

MERCEDES BENZ

280 E Sedan	1992-93
280 TE Kombi	1992-93
320 CE Coupe	1992-93
320 E Sedan	1992-93
320 GE Cabrio	1994-97
320 TE Kombi	1992-93
C 36 AMG	1994-00
C 180	1993-00
C 180 T	1996-00

MERCEDES BENZ Cont.

C 200	1994-00
C 200 Kompressor	1995-00
C 200 Kompressor, T Kombi	1996-00
C 200 T Kombi	1996-01
C 220	1993-00
C 230	1996-97
C 230 Kompressor, T Kombi	1995-00
C 230 T Kombi	1996-98
C 280	1993-00
CLK 200 Kompressor, Cabrio	1997-00
CLK 200, Cabrio	1997-02
CLK 230 Kompressor, Cabrio	1997-00
E 36 AMG Cabrio, Coupe, T Kombi	1994-96
E 36 AMG Coupe	1993-95
E 200 Kompressor, T Kombi	1997-02
E 200, Cabrio, Coupe, T Kombi	1993-97

Ref. 80212

Suitable / Reemplaza:

Mercedes 001 150 04 80
000 150 05 80
000 158 68 03



0,45 Ω

7,8 KΩ

Ø 4



MERCEDES BENZ

200 E Sedan	1992-93
200 TE Kombi	1992-93
220 CE Coupe	1992-93
220 E Sedan	1992-93
220 TE Kombi	1992-93
C 180	1993-00
C 180 T	1996-00
C 200	1994-00
C 200 T Kombi	1996-01
C 220	1993-00
CLK 200, Cabrio	1997-02
E 200, Cabrio, Coupe, T Kombi	1993-95
E 220, Cabrio, Coupe, T Kombi	1993-95

Ref. 80213

Suitable / Reemplaza:

Ford 1649067
6181956
6503277
6503278
6503279
6503280
6823318
6860288
6860289
7U2J-12029-AB
88SF-12029-A1A
Mazda 18E05-18-100
18E05-18-100 A
ZZM0-18-100



0,70 Ω

13,5 KΩ

Ø 7



FORD Cont.

Escort VII 1.4, Cabrio	1995-98
Escort VII 1.4, Kombi	1995-99
Escort VII 1.6 16V, Cabrio, Kombi, 4x4	1995-98
Escort VII 1.6 i 16V Sedan	1995-99
Escort VII 1.6 i 16V, Cabrio, Kombi	1995-95
Escort VII 1.8 16V XR3i Cabrio	1995-00
Escort VII 1.8 16V XR3i, Cabrio, Kombi	1995-95
Escort VII 1.8 16V XR3i, Cabrio, Sedan	1995-95
Escort VII 1.8 16V, Cabrio, Kombi	1995-98
Fiesta 1.3 Furgón	1991-96
Fiesta 1.4 i Furgón	1996-99
Fiesta III 1.1	1989-95
Fiesta III 1.3	1989-92
Fiesta III 1.3 Kat	1991-97
Fiesta III 1.4	1989-95
Fiesta III 1.4 Kat	1989-95
Fiesta III 1.6	1989-92
Fiesta III 1.6 i 16V	1994-95
Fiesta III 1.6 Turbo	1990-92
Fiesta III 1.6 XR2i	1989-93
Fiesta III 1.8 16V	1992-95
Fiesta III 1.8 XR2i 16V	1992-95
Fiesta IV 1.25 i 16V	1995-02
Fiesta IV 1.3 i	1995-02
Fiesta IV 1.4 i 16V	1996-02
Fiesta IV 1.6 16V Sport	2000-02
Ka 1.3 i	1996-02
Ka 1.3 i, Van	1996-08
Mondeo I 1.6 i 16V, Kombi, Sedan	1993-96
Mondeo I 1.8 i 16V, Kombi, Sedan	1994-96
Mondeo I 1.8 i 16V, Kombi, Sedan	1993-96
Mondeo I 1.8 i 16V, Kombi, 4x4	1993-96

FORD Cont.

Mondeo I 2.0 i 16V, Kombi, Sedan	1993-96
Mondeo I 2.0 i 16V, Kombi, 4x4	1993-96
Mondeo II 1.6 i 16V, Kombi, Sedan	1998-00
Mondeo II 1.6 i, Kombi, Sedan	1996-00
Mondeo II 1.8 i, Kombi, Sedan	1996-00
Mondeo II 2.0 i, Kombi, Sedan	1996-00
Orion II 1.3	1985-90
Orion II 1.4	1985-90
Orion II 1.4 Kat	1987-90
Orion II 1.6	1985-90
Orion II 1.6 i	1986-90
Orion II 1.6 i Kat	1986-90
Orion III 1.3	1990-93
Orion III 1.4	1990-93
Orion III 1.6	1990-92
Orion III 1.6 i	1990-92
Orion III 1.6 i 16V	1992-93
Orion III 1.8 i 16V	1992-93
Puma 1.4 16V	1997-00
Puma 1.7 16V	1997 ->
Scorpio I 2.0 i, Kombi, Sedan	1989-94
Sierra 1.6 i, Kombi	1989-93
Sierra 1.6, Kombi	1987-93
Sierra 1.8, Kombi	1988-93
Tourneo Connect 1.8 16V	2002 ->
Transit Connect 1.8 16V	2002 ->

FORD

Escort '86 1.1 Express	1986-90
Escort '86 1.3 Express	1988-90
Escort '91 1.3 Express	1990-94
Escort '91 1.4 Express	1990-94
Escort '95 1.4 Express	1995 ->
Escort Classic 1.6 16V	1998-00
Escort Classic Turnier 1.6 16V	1999-00
Escort IV 1.3, Express	1988-90
Escort IV 1.4, Cabrio, Kombi	1986-90
Escort IV 1.6	1989-90
Escort IV 1.6 i, Cabrio	1989-90
Escort IV 1.6 i, Cabrio, Kombi	1986-90
Escort IV 1.6 Turbo RS	1986-90
Escort IV 1.6 XR3i, Cabrio	1986-89
Escort V 1.3, Kombi	1990-92
Escort V 1.4, Cabrio, Kombi	1990-92

FORD Cont.

Escort V 1.6, Cabrio, Kombi	1990-92
Escort V 1.6, Kombi	1990-92
Escort V 1.8 16V XR3i, Cabrio	1992-92
Escort VI 1.3, Kombi	1992-95
Escort VI 1.4	1994-95
Escort VI 1.4 i Cabrio	1993-95
Escort VI 1.4, Cabrio, Kombi, Sedan	1992-94
Escort VI 1.4, Kombi	1993-95
Escort VI 1.6 i 16V Sedan	1993-95
Escort VI 1.6 i 16V, Cabrio, Kombi	1992-95
Escort VI 1.8 16V XR3i, Cabrio	1992-95
Escort VI 1.8 16V XR3i, Kombi, 4x4	1992-95
Escort VI 1.8 i 16V XR3i, Cabrio, Kombi	1992-95
Escort VI 1.8 i 16V XR3i, Sedan, 4x4	1992-95
Escort VII 1.3, Kombi	1995-98



Ref. 80214

Suitable / Reemplaza:	
Ford	1052492 1053904 1066102 1067601 1075786 1119835 1130402
Mazda	1E03-18-10X 1E03-18-10X A 1E03-18-10X B 1E04-18-10X 1E05-18-100 B C201-18-100 A
Volvo	30735759

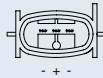

0,59 Ω

11 KΩ

Ø 4



FORD Cont.	
Mondeo II 1.6 i 16V, Kombi, Sedan	1998-00
Mondeo II 1.6 i, Kombi, Sedan	1996-00
Mondeo II 1.8 i, Kombi, Sedan	1996-00
Mondeo II 2.0 i, Kombi, Sedan	1996-00
Puma 1.4 16V	1997-00
Puma 1.6 16V	2000 ->
Puma 1.7 16V	1997 ->
Street Ka 1.6	2003-05
Tourneo Connect 1.8 16V	2002 ->
Transit Connect 1.8 16V	2002 ->

MAZDA	
2 1.25	2003 ->
2 1.4	2003 ->
2 1.6	2003 ->
121 III 1.25	1996 ->
121 III 1.3	1996 ->

VOLVO	
S40 II 1.6	2005 ->
V50 1.6	2005 ->

FORD	
Cougar 2.0 16V	1998-01
Escort VII 1.3, Kombi	1995-98
Fiesta 1.3 Furgón	1996 ->
Fiesta IV 1.0 i	1997-99
Fiesta IV 1.25 i 16V	1995-02
Fiesta IV 1.3 i	1995-02
Fiesta IV 1.4 i 16V	1996-02
Fiesta IV 1.6 16V Sport	2000-02
Fiesta V 1.25 16V	2002 ->
Fiesta V 1.3	2001 ->
Fiesta V 1.3, Van	2001 ->
Fiesta V 1.4 16V	2001 ->
Fiesta V 1.6 16V	2001 ->
Focus 1.4 16V, Kombi, Sedan	1998-04
Focus 1.6 16V, Kombi, Sedan	1998-04
Focus 1.8 16V, Kombi, Sedan	1998-04

FORD Cont.	
Focus 2.0 16V, Kombi, Sedan	1998-04
Focus C-Max 1.6	2003-07
Focus C-Max 1.6 Ti	2004-07
Focus II 1.4, Sedan, Turnier	2004 ->
Focus II 1.6 Ti, Sedan, Turnier	2004 ->
Focus II 1.6, Sedan, Turnier	2004 ->
Focus RS	2002-04
Focus ST170, Kombi	2002-04
Fusion 1.25	2004 ->
Fusion 1.4	2002 ->
Fusion 1.6	2002 ->
Galaxy 2.3 16V	2001-06
Ka 1.3 i	1996-02
Ka 1.3 i, Van	1996-08
Ka 1.6 i	2003-08
Maverick 2.0 16V	2001 ->

Ref. 80215

Suitable / Reemplaza:	
BMW	1 720 166 1 726 176 1 726 177 1 726 178 1 726 178 B 1 730 765 1 731 134 B 1 731 178 B 1 748 394 1 777 666 12 13 1 317 232 12 13 1 402 440 12 13 1 402 713 12 13 1 703 359

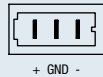

0,40 Ω

Ø 4



BMW	
318 is	1989-91
318 is, Coupe	1992-95
320 i Cabrio	1993-99
320 i, Coupe	1990-98
325 i Cabrio	1993-95
325 i, Coupe	1990-95
330 Ci Cabrio, Coupe	2000 ->
520 i 24V, Touring	1989-95
520 i Touring	1991-97
525 i 24V	1989-95
525 i Touring	1991-97
525 i X 24V	1991-95
525 i X Touring	1992-97
530 i V8, Touring	1992-95

BMW Cont.	
540 i V8, Touring	1992-95
730 i,iL	1994-01
730 i,iL V8	1992-94
740 i,iL	1994-01
740 i,iL V8	1992-94
840 i	1993-96
M3 3.0, Cabrio, Coupe	1992-95
M5 3.8, Touring	1992-95

Ref. 80216

Suitable / Reemplaza:	
BMW	1 404 309 1 703 227 1 703 228 1 703 228 1 703 825 1 748 017 1 748 018 12 13 1 703 227 12 13 1 703 228 12 13 1 703 825 12 13 1 748 017
Land Rover	NEC000040 NEC101000L
Rover	GCL 307 NEC 101000

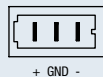

0,50 Ω

Ø 4



BMW Cont.	
850 Ci	1994-99
M3 3.2, Cabrio, Coupe	1995-98
M5	1998-03
X5 3.0 i	2000 ->
X5 4.4 i	2000 ->
X5 4.6 is	2002 ->
Z3 2.0	1999-03
Z3 2.2	2000-03
Z3 2.8	1997-00
Z3 2.8 Coupe	1997-00
Z3 3.0	2000-03
Z3 3.0 Coupe	2000-03
Z3 M 3.2, Coupe	1997-01
Z8 4.9	2000-03

LAND ROVER	
Freelander 2.5 V6	2000 ->
Range Rover III 4.4	2002 ->

MG	
MG ZS 180, Fastback	2001 ->
MG ZT 160	2001 ->
MG ZT 180	2003 ->
MG ZT 190	2001 ->
MG ZT-T 160	2001 ->
MG ZT-T 180	2003 ->
MG ZT-T 190	2001 ->

ROVER	
45 2.0 V6, Sedan	2000 ->
75 2.0 V6, Tourer	1999 ->
75 2.5 V6	1999-01
75 2.5 V6 Tourer	2001 ->

BMW	
320 Ci Cabrio, Coupe	2000 ->
320 Ci Coupe	1999-00
320 i Cabrio	1993-99
320 i Touring	1995-99
320 i, Coupe	1990-98
320 i, Touring	1998-00
323 Ci Cabrio, Coupe	1999-00
323 i	1998-00
323 i 2.5, Cabrio, Coupe, Touring	1995-98
323 ti Compact	1997-00
325 Ci Cabrio, Coupe	2000 ->
325 i, Touring	2000-05
325 ti Compact	2001-05
325 xi, Touring	2000-05
328 Ci Coupe	1999-00
328 i, Cabrio, Coupe, Touring	1995-98

BMW Cont.	
328 i, Touring	1998-00
330 Ci Cabrio, Coupe	2000 ->
330 i, Touring	2000-05
330 xi, Coupe, Touring	2000 ->
520 i, Touring	1996-00
523 i, Touring	1995-00
525 i, Touring	2000-03
528 i, Touring	1995-00
530 i, Touring	2000-03
535 i	1996-99
540 i, Touring	1996-03
728 i, iL	1995-01
735 i,iL	1996-01
740 i,iL	1996-01
750 i,iL	1994-01
840 Ci	1996-99



Ref. 80217

Suitable / Reemplaza:

Alfa Romeo 60805420
60809492
Fiat 46543562
46548037
46790073
7626232
7672018
Lamborghini 16004528



0,62 Ω

8,6 KΩ

Ø 8,2



FIAT Cont.

Model	Year	LANCIA	Year
Panda 1000 4x4	1986-94	Dedra 1.8 i.e.	1993-99
Panda 1000 i.e. Van	1992-04	Dedra 1.8 i.e., SW	1994-99
Panda 1000 i.e. Kat	1987-98	Delta I 2.0 16V HF Evo Integrale	1993-94
Panda 1100	1995-03	Delta II 1.8 i.e.	1993-99
Panda 1100 4x4	1995-04	Delta II 2.0 16V Turbo	1993-99
Panda 1100, Trekking 4x4	1991-04	Thema 2000 16V Turbo, SW	1988-90
Punto 1.1 Van	1996-00	Thema 2000 i.e. 16V Turbo, SW	1989-92
Punto 1.2 60, Van	1999 ->	Thema 2000 i.e. 16V, SW	1988-92
Punto 1.2 Natural Power	2003 ->	Y 1.1	1995-03
Punto 55 1.1	1993-99	Y 1.2	1996-04
Punto 60 1.2, Cabrio	1994-00	Y 1.2 16V	1997-03
Punto 75 1.2	1993-99	Ypsilon 1.2	2003 ->
Punto 85 16V 1.2, Cabrio	1997-00		
Seicento 0.9, Van	1998 ->		
Seicento 1.1, Van	1998 ->		
Siena 1.2	1998 ->		
Siena 1.4	1996 ->		
Siena 1.4 Kat	1996 ->		
Strada 1.2	1999 ->		
Tempra 1.8 i.e., S.W.	1990-96		
Tipo 1.8 i.e	1993-95		
Tipo 1.8 i.e.	1993-95		

ALFA ROMEO

Model	Year	FIAT Cont.	Year
33 1.4 i.e., Sport Wagon	1991-94	Palio 1.0	1996 ->
33 1.4 i.e., Sport Wagon, 4x4	1991-94	Palio 1.2	1998 ->
145 1.4 i.e.	1994-96	Palio 1.2 Weekend	1996-01
146 1.4 i.e.	1994-96	Palio 1.4	1996 ->
155 2.0 16V Turbo Q4	1992-97	Palio 1.4 Kat	1996 ->
FIAT		Panda 1.1	2003 ->
Cinquecento 0.7	1991-96	Panda 1.2	2003 ->
Cinquecento 0.7 i	1994-98	Panda 1.2 4x4	2004 ->
Cinquecento 0.9	1991-93	Panda 1.2 Bi-Power / Natural Power	2007 ->
Cinquecento 0.9 i.e.	1991-93	Panda 1.2 Flexfuel Weekend	1997-02
Cinquecento 0.9 i.e. S	1991-99	Panda 1.2 LPG	2009 ->
Cinquecento 1.1 Sporting	1994-98	Panda 1.2 LPG Weekend	1997-02
Coupe 2.0 16V Turbo	1993-96	Panda 1.2 Van	2004 ->
Doblo 1.2	2001 ->	Panda 1.2 Van 4x4	2004 ->
Doblo 1.2 Cargo	2001 ->	Panda 1.2 Weekend	2001 ->
Elba 1.5	1992-96	Panda 900	1992-96

Ref. 80218

Suitable / Reemplaza:

Volkswagen 032 905 106
032 905 106 B
032 905 106 D
032 905 106 E



GND IN2 + IN1

5 KΩ

Ø 4



SKODA Cont.

Model	Year	VOLKSWAGEN Cont.	Year
Octavia 2.0	1999-07	Golf VI 1.6 MultiFuel	2008 ->
Octavia 2.0 4x4 Combi	2000-04	Golf VI 1.6 Variant	2009 ->
Octavia 2.0 Combi	1999-07	Jetta III 1.6	2005-10
Roomster 1.2 TSI	2010 ->	Jetta IV 1.2 TSI	2011 ->
Roomster Praktik 1.2 TSI	2010 ->	Lupo 1.0	1998-05
Superb 2.0	2002-08	Lupo 1.4	2000-05
Yeti 1.2 TSI	2009 ->	Lupo 1.4 16V	1998-05
VOLKSWAGEN		Lupo 1.6 GTI	2000-05
Bora 1.4 16V	2000-05	Multivan V 2.0	2003 ->
Bora 1.4 16V Kombi	2001-05	New Beetle 1.6	1999-00
Bora 1.6	2000-05	New Beetle 1.6 Cabrio	2003-10
Bora 1.6 16V, Kombi	2000-05	New Beetle 2.0	1998 ->
Bora 1.6 Kombi	2000-05	New Beetle 2.0 Cabrio	2002-10
Bora 1.6, Kombi	1998-05	Passat 1.6, Variant	1996-00
Bora 1.8	1998-05	Passat 2.0	2000-05
Bora 1.8 4motion, Kombi	1999-05	Passat 2.0, 4motion, Variant	2000-05
Bora 1.8 T	2000-05	Polo 1.0	1999-01
Bora 2.0	1998-05	Polo 1.2 TSI	2009 ->
Bora 2.0 4motion, Kombi	2000-05	Polo 1.4	1999-01
Bora 2.0 Kombi	1999-05	Polo 1.4 16V	1999-01
Caddy II 1.4	1995-04	Polo 1.4 16V Variant	1999-01
Caddy II 1.4 16V	2000-04	Polo 1.4 Variant	1998-01
Caddy II 60 1.4	1995-04	Polo 1.6 16V GTI	1999-01
Caddy III 1.2 TSI	2010 ->	Polo 1.6 Variant	1997-01
Caddy III 1.6	2004 ->	Polo 100 1.6 Classic	1995-01
Fox 1.4	2005 ->	Polo 120 1.6 16V GTI	1998-99
Golf IV 1.4 16V	1997-05	Polo 60 1.4 Classic	1995-01
Golf IV 1.4 16V, Variant	1999-06	Polo 75 1.4 16V Classic	1999-01
Golf IV 1.6	2000-05	Sharan 2.0	1995-10
Golf IV 1.6 16V, Variant	2000-05	Sharan 2.0 LPG	2006-10
Golf IV 1.6 Variant	2000-06	Touran 1.6	2003-10
Golf IV 1.6, Variant	1997-00	Transporter V 2.0	2003 ->
Golf IV 1.8	1997-05		
Golf IV 1.8 4motion, Variant	1998-05		
Golf IV 2.0	1998-04		
Golf IV 2.0 4motion, Variant	2000-05		
Golf IV 2.0 Bi-Fuel Variant	2002-06		
Golf IV 2.0 Variant	1999-06		
Golf Plus 1.2 TSI	2009 ->		
Golf Plus 1.6	2005 ->		
Golf Plus 1.6 BiFuel	2009 ->		
Golf Plus 1.6 MultiFuel	2007 ->		
Golf V 1.6	2004-08		
Golf V 1.6 Variant	2007 ->		
Golf V 2.0	2006-08		
Golf VI 1.2 TSI	2009 ->		
Golf VI 1.2 TSI Variant	2009 ->		
Golf VI 1.2 TSI, Variant	2010 ->		
Golf VI 1.6	2008 ->		
Golf VI 1.6 BiFuel	2009 ->		

AUDI

Model	Year	SEAT Cont.	Year
A1 1.2 TFSI, Sportback	2010 ->	Ibiza IV 1.4 16V	2002-09
A2 1.4	2000-05	Ibiza IV 1.6	2003-09
A3 1.2 TSI, Cabrio, Sportback	2010 ->	Ibiza IV 2.0	2002-09
A3 1.6	1996-00	Ibiza V 1.2 TSI	2010 ->
A3 1.6 Cabrio	2008 ->	Ibiza V 1.2 TSI Sportcoupe	2010 ->
A3 1.6, Sportback	2003 ->	Ibiza V 1.2 TSI ST	2010 ->
A3 1.8	1996 ->	Inca 1.4 16V	2000-03
A4 1.6, Avant	1994-00	Inca 1.4 i	1995-03
SEAT		Leon 1.2 TSI	2010 ->
Alhambra 2.0 i	1996-10	Leon 1.4 16V	1999-06
Altea 1.2 TSI	2010 ->	Leon 1.6	1999-06
Altea 1.6	2004 ->	Leon 1.6 16V	2000-06
Altea 1.6 LPG	2009 ->	Leon 1.6 LPG	2009 ->
Altea XL 1.2 TSI	2010 ->	Leon 1.8 20V	1999-06
Altea XL 1.6	2006 ->	Toledo II 1.4 16V	1999-06
Altea XL 1.6 LPG	2009 ->	Toledo II 1.6	1999-00
Arosa 1.0	1997-04	Toledo II 1.6 16V	2000-06
Arosa 1.4	1997-04	Toledo II 1.8 20V	1999-06
Arosa 1.4 16V	2000-04	Toledo III 1.6	2004-09
Cordoba 1.0 Fastback	1999-02	SKODA	
Cordoba 1.4 16V	2000-02	Fabia 1.2 TSI	2010 ->
Cordoba 1.4 16V, Fastback, Vario	1999-02	Fabia 1.2 TSI Combi	2010 ->
Cordoba 1.4, Fastback, Vario	1999-02	Fabia 1.4 16V, Combi, Sedan	1999-07
Cordoba 1.6	2003-09	Fabia 2.0	1999-08
Cordoba 1.6, Fastback, Vario	1999-02	Fabia 2.0, Combi, Sedan	1999-07
Cordoba 2.0	2002-09	Octavia 1.2 TSI	2010 ->
Exeo 1.6	2009 ->	Octavia 1.2 TSI Combi	2010 ->
Exeo 1.8 T	2008 ->	Octavia 1.4 16V, Combi	2000-10
Exeo ST 1.6	2009 ->	Octavia 1.6 LPG	2009 ->
Exeo ST 1.8 T	2009 ->	Octavia 1.6 LPG Combi	2009 ->
Ibiza III 1.0	1999-02	Octavia 1.6 MultiFuel	2008 ->
Ibiza III 1.4	1999-02	Octavia 1.6 MultiFuel Combi	2008 ->
Ibiza III 1.4 16V	1999-02	Octavia 1.6, Combi	1997-07
Ibiza III 1.6	1999-02	Octavia 1.8, Combi	1996-00



Ref. 80219

Suitable / Reemplaza:

Volkswagen 701 905 104
701 905 104 A
867 905 105 A



①

+ OUT TACH1



IN GND GND

3,3 KΩ

Ø 4



AUDI		VOLKSWAGEN	
80 2.0 E, Avant, quattro	1992-96	Golf II 1.3 Kat	1986-92
SEAT		Passat 1.6, Variant	1988-88
Cordoba 1.8 i 16V	1993-96	Passat 1.8, Variant	1988-96
Ibiza II 1.3 i	1993-99	Passat 2.0 16V, Variant	1994-96
Ibiza II 1.8 i	1993-99	Passat 2.0, Syncro, Variant	1990-96
Ibiza II 2.0 i	1993-99	Polo 1.0 Classic	1985-94
Toledo I 1.6 i	1991-93	Polo 1.0 Kat, Coupe	1989-94
Toledo I 1.8 i	1993-96	Polo 1.0, Coupe	1985-92
Toledo I 2.0 i	1991-99	Polo 1.3 Furgón	1992-94
Toledo I 2.0 i 16V	1993-99	Polo 1.3 Kat Classic	1987-94
		Polo 1.3 Kat, Coupe	1987-94
		Transporter IV 1.8	1990-92
		Transporter IV 2.0	1990-03
		Vento 1.6	1992-98

Ref. 80220

Suitable / Reemplaza:

Renault 77 00 863 020
77 00 865 923
77 01 041 607
Volvo 70863020
70863020-7

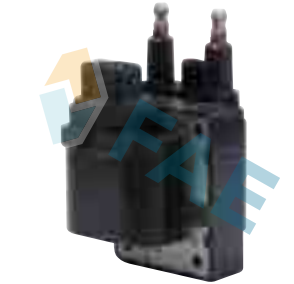

①



- + +

0,64 Ω

10 KΩ

Ø 6



RENAULT		VOLVO	
Laguna 2.0	1995-01	S40 1.8	1995-99
Laguna 2.0 16V, Grandtour	1995-01	S40 1.2.0	1995-03
Megane I 1.6 e Cabrio, Coach	1996-99	V40 1.6 Kombi	1995-99
Megane I 1.6 e Cabrio, Grandtour	1996-99	V40 1.8 Kombi	1995-99
Megane I 1.6 e, Classic	1996-99	V40 2.0 Kombi	1995-04
Megane I 1.6 i, Classic	1996-99		
Megane Scenic 1.6 e	1997-99		
Megane Scenic 1.6 i	1997-99		
Safrane II 2.0 16V	1996-00		
S40 I 1.6	1995-99		

Ref. 80221

Suitable / Reemplaza:

Renault 77 01 041 608
Volvo 70863021
70863021-5



①



- + +

1 Ω

9 KΩ

Ø 6



RENAULT		VOLVO	
Laguna 2.0	1995-01	S40 I 1.6	1995-99
Laguna 2.0 16V, Grandtour	1995-01	S40 I 1.8	1995-99
Megane I 1.6 e Cabrio, Coach	1996-99	S40 I 2.0	1995-03
Megane I 1.6 e Cabrio, Grandtour	1996-99	V40 1.6 Kombi	1995-99
Megane I 1.6 e, Classic	1996-99	V40 1.8 Kombi	1995-99
Megane I 1.6 i, Classic	1996-99	V40 2.0 Kombi	1995-04
Megane Scenic 1.6 e	1997-99		
Megane Scenic 1.6 i	1997-99		
Safrane II 2.0 16V	1996-00		

Ref. 80222

Suitable / Reemplaza:

Dacia 6001 543 604
Nissan 22448-00QAC
Renault 77 00 274 008



①



- - + +

0,85 Ω

10,5 KΩ

Ø 4



RENAULT Cont.			
Logan 1.4, Kombi	2004 ->		
Logan 1.6, Kombi	2004 ->		
Megane I 1.4 e Grandtour	1999 ->		
Megane I 1.4 e, Classic	1996 ->		
Megane I 1.6 e Cabrio, Coach	1996-99		
Megane I 1.6 e Cabrio, Grandtour	1996-99		
Megane I 1.6 e, Classic	1996-99		
Megane I 1.6 i, Classic	1996-99		
Megane I 2.0 16V IDE, Cabrio, Coach	1999 ->		
Megane Scenic 1.6 e	1997-99		
Megane Scenic 1.6 i	1997-99		
Modus 1.2 16V	2007 ->		
Modus 1.6	2004 ->		
Thalia 1.4	2000 ->		
Twingo 1.2	1996 ->		
Twingo 1.2 16V	2001 ->		
Twingo 1.2 TCe 100	2011 ->		
Twingo 1.2 Turbo	2007 ->		
Wind 1.2	2010 ->		
Wind 1.2 TCe 100	2011 ->		

DACIA		RENAULT	
Logan 1.4	2004 ->	Clio 1.2 16V Grandtour	2008 ->
Logan 1.4 MCV	2007 ->	Clio I 1.2	1996-98
Logan 1.4 MPI LPG	2006 ->	Clio II 1.1 Furgón	1998 ->
Logan 1.6	2004 ->	Clio II 1.2	1998 ->
Logan 1.6 16V MCV Bifuel	2008 ->	Clio II 1.2 Furgón	1999-03
Logan 1.6 MCV	2007 ->	Clio II 1.4	1998-05
Logan 1.6 Pick-up	2008 ->	Clio II 1.6	1998-05
Sandero 1.4	2008 ->	Clio II 2.0 16V Sport	2000 ->
Sandero 1.4 MPI LPG	2009 ->	Clio III 1.2 16V	2007 ->
Sandero 1.6	2008 ->	Kangoo 1.2 Express	1998-01
Solenza 1.4	2003 ->	Kangoo 1.2, Express	1997 ->
		Kangoo 1.4	1997 ->
		Kangoo 1.4 Express	1997 ->
		Kangoo 1.6 16V bivalent	2005 ->
		Kangoo 1.6 Express	2008 ->
		Kangoo 1.6, Express	2008 ->



Ref. 80223

Suitable / Reemplaza:

G.M. 90458250
Opel 1208071



①



0,68 Ω

7 KΩ

Ø 4



OPEL

Astra F 1.8 i 16V, Cabrio, Caravan, CC	1994-01
Astra F 1.8 i 16V, Caravan, CC	1993-94
Astra F 2.0 i 16V Classic CC	1998-00
Astra F 2.0 i 16V, Caravan, CC	1995-98
Astra G 2.0 16V Caravan	1998-04
Astra G 2.0 16V CC	1998-05
Astra G 2.0 16V Sedan	1998-05
Astra G CC 2.0 16V OPC	1999-02
Calibra A 2.0 i 16V, 4x4	1994-97
Omega B 2.0 16V, Caravan	1994-99
Vectra A 2.0 i 16V, 4x4, CC	1994-95
Vectra B 2.0 i 16V, Caravan, CC	1995-00

VAUXHALL

Ref. 80224

Suitable / Reemplaza:

G.M. 09119567
90536194
Opel 1208008
Saab 91 19 567



①

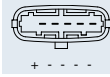

0,70 Ω



Ø 4



OPEL

Astra F 1.8 Classic Caravan	2003-04
Astra G 1.8 16V Cabrio	2001-05
Astra G 1.8 16V Caravan	1998-00
Astra G 1.8 16V CC	1998-00
Astra G 1.8 16V Coupe	2000-00
Astra G 1.8 16V Sedan	1998-00
Astra G 2.0 16V Caravan	1998-04
Astra G 2.0 16V CC	1998-05
Astra G 2.0 16V Sedan	1998-05
Astra H 1.8, Caravan, GTC	2004 ->
Corsa C 1.8	2000 ->
Meriva 1.8	2003-10
Signum 1.8	2003 ->
Tigra 1.8 TwinTop	2004 ->

OPEL Cont.

Vectra B 1.8 i 16V, Caravan, CC	1995-00
Vectra C 1.8	2002 ->
Vectra C 1.8 16V, Caravan, GTS	2002 ->
Zafira 1.8 16V	1999-00

SAAB

9-3 1.8 i	2004 ->
9-3 1.8 i Kombi	2005 ->

VAUXHALL

Ref. 80225

Suitable / Reemplaza:

Nissan 22448-00QAF
Renault 82 00 360 911
82 00 734 204



①

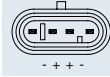

0,4 Ω

10 KΩ

Ø 6,35



NISSAN

Kubistar 1.2 16V	2006 ->
------------------	---------

RENAULT

Clio 1.2 16V Grandtour	2008 ->
Clio 1.2 16V Grandtour, Hi-Flex	2008 ->
Clio II 1.2 16V	2001 ->
Clio III 1.2 16V	2005 ->
Clio III 1.2 16V, Hi-Flex	2005 ->
Kangoo 1.2 16V	2001 ->
Kangoo 1.2 16V Express	2001 ->
Modus 1.2	2005 ->
Modus 1.2, Hi-Flex	2004 ->
Twingo 1.2 16V	2004 ->

Ref. 80226

Suitable / Reemplaza:

Citroën 96.246.755.80
96.281.585.80
Peugeot 5970.72
5970.74
5970.A9



①

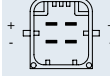

0,52 Ω

6 KΩ

Ø 7,5



CITROËN

AX 1.0	1987-98
Berlingo 1.1 i	1996 ->
Berlingo 1.4 i	1996 ->
Saxo 1.0 X	1996-98
Saxo 1.1 X, SX	1996-03
Saxo 1.4 VTS	1996-03
Saxo 1.6	1996-03
Saxo 1.6 VTL, VTR	1996-03
Xsara 1.4 i, Break, Coupe	1997-05
Xsara 1.6 i, Break, Coupe	1997-00
Xsara Picasso 1.6	1999 ->

PEUGEOT Cont.

106 II 1.4 i	1996 ->
205 II 1.1	1989-98
206 1.1	1998-00
206 1.1 i	1998 ->
206 1.4 16V, SW	2003 ->
206 1.4 i	1998 ->
206 1.6 i	1998-00
306 1.4	1993-01
306 1.4 Break	1997-02
306 1.4 SL	1994-01
306 1.6 SR, Break, Cabrio	1993-00
Partner 1.1	1996 ->
Partner 1.1 Combispac	1996 ->
Partner 1.4, Combispac	1996 ->

Ref. 80227

Suitable / Reemplaza:

Alfa Romeo 7793212



①

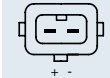

0,33 Ω

7 KΩ

Ø 4 - Ø 5



ALFA ROMEO

145 1.4 i.e. 16V T. S.	
145 1.6 i.e. 16V T. S.	
145 1.8 i.e. 16V	
145 1.8 i.e. 16V T. S.	
145 2.0 16V Quadrifoglio	
145 2.0 16V T. S.	
146 1.4 i.e. 16V T. S.	
146 1.6 i.e. 16V T. S.	
146 1.8 i.e. 16V T. S.	
146 2.0 16V Quadrifoglio	
146 2.0 16V T. S.	
155 1.6 16V T. S.	
155 1.7 T. S. 16V	
155 2.0 T. S. 16V	

ALFA ROMEO Cont.

156 1.6 16V T. S., Sportwagon	
156 1.8 16V T. S., Sportwagon	
156 2.0 16V T. S., Sport Wagon	
166 2.0 T. S.	
GTV 1.8 16V	
GTV 2.0 T. S. 16V	
Spider 1.8 16V	
Spider 2.0 T. S. 16V	



Ref. 80229

Suitable / Reemplaza:
Alfa Romeo 46755605



①



0,33 Ω

14,5 KΩ

Ø 4 - Ø 5



ALFA ROMEO		
147 1.6 16V T. S.	2001 ->	
147 1.6 16V T. S. Eco	2001 ->	
147 2.0 16V T. S.	2001 ->	
156 1.6 16V T. S., Sportwagon	1997-05	
156 1.8 16V T. S., Sportwagon	2000-00	
156 2.0 16V T. S., Sport Wagon	2000-00	
156 2.0 16V T. S., Sportwagon	2000-02	
166 2.0 T. S.	2000 ->	
GT 1.8 TS	2003 ->	
GTV 1.8 16V	1998 ->	
GTV 2.0 T. S. 16V	1995 ->	
Spider 1.8 16V	1998-05	
Spider 2.0 T. S. 16V	1995-05	

Ref. 80231

Suitable / Reemplaza:

Ford 1224925
1314271
1322402
1578771
4M5G-12A366-BA
4M5G-12A366-BB
4M5G-12A366-BC
4M5G-12A366-BD

Mazda LF16-18-100
LF16-18-100A
LF16-18-100B

Volvo 30711786



①



0,50 Ω

5,3 KΩ

Ø 6,35



VOLVO Cont.		
S80 II 2.0 FlexFuel	2008 ->	
V50 1.8	2004 ->	
V50 1.8 FlexFuel	2005 ->	
V50 2.0	2006 ->	
V70 III 2.0 FlexiFuel Kombi	2008 ->	
V70 III 2.0 Kombi	2007 ->	

FORD		FORD Cont.	
C-Max 1.8	2007 ->	Mondeo IV 2.0 Flexifuel Turnier	2007 ->
C-Max 1.8 Flexifuel	2007 ->	Mondeo IV 2.0, Sedan, Turnier	2007 ->
C-Max 2.0	2007 ->	S-Max 2.0	2006 ->
Focus C-Max 1.8	2003-07	S-Max 2.0 Flexifuel	2006 ->
Focus C-Max 1.8 Flexifuel	2006-07	Transit 2.3 16V	2006 ->
Focus C-Max 2.0	2004-07	MAZDA	
Focus II 1.8 Flexifuel, Sedan, Turnier	2006 ->	3 2.0	2003 ->
Focus II 1.8, Sedan, Turnier	2006 ->	3 2.0 Sedan	2004 ->
Focus II 2.0 Cabrio	2006 ->	VOLVO	
Focus II 2.0 CNG	2009 ->	C30 1.8	2006 ->
Focus II 2.0 LPG, Turnier	2008 ->	C30 1.8 Flexfuel	2007 ->
Focus II 2.0, Sedan, Turnier	2004 ->	C30 2.0	2006 ->
Galaxy 2.0	2006 ->	S40 II 1.8	2004 ->
Maverick 2.3 16V	2004 ->	S40 II 1.8 Flexfuel	2006 ->
Mondeo IV 2.0 Flexifuel	2007 ->	S40 II 2.0	2006 ->
Mondeo IV 2.0 Flexifuel Sedan	2007 ->	S80 II 2.0	2008 ->

Ref. 80232

Suitable / Reemplaza:

Renault 77 00 107 269
Seat SE-028915000B



①

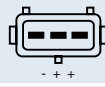

0,55 Ω

7,5 KΩ

Ø 4



RENAULT		SEAT	
Espace III 2.0	1996-00	Marbella 0.9 Kat Furgón	1987-93
Laguna 1.8	1993-01	Marbella 0.9 Kat, Furgón	1990-96
Laguna 1.8, Grandtour	1995-01	Marbella 0.9, Furgón	1987-93
Laguna 2.0	1999-01	Marbella 0.9, Kat	1996-98
Laguna 2.0, Grandtour	1993-01	Terra 0.9 Kat, Furgón	1990-95
Megane I 2.0 Cabrio	1997 ->	Terra 0.9, Furgón	1987-95
Megane I 2.0 i	1999 ->		
Megane I 2.0 i Cabrio	1999 ->		
Megane I 2.0 i Classic	1999 ->		
Megane I 2.0 i Coach	1999-03		
Megane I 2.0 i, Classic, Coach	1996 ->		
Megane Scenic 2.0 i	1997-99		

Ref. 80233

Suitable / Reemplaza:

Fiat 46777288
504142675



①



0,52 Ω



Ø 6,35



ALFA ROMEO		FIAT Cont.	
Mito 1.4	2008 ->	Punto 1.4	2003 ->
FIAT		Stilo 1.2 16V	2002 ->
500 1.4	2007 ->	Stilo 1.4 16V, Multi Wagon	2004 ->
500 C 1.4	2009 ->	LANCIA	
Bravo II 1.4	2007 ->	Musa 1.4	2004 ->
Bravo II 1.4 LPG	2009 ->	Ypsilon 1.2	2003 ->
Bravo II 1.4 T-Jet	2007 ->	Ypsilon 1.4 16V	2003 ->
Doblo 1.4	2010 ->		
Doblo 1.4 Cargo	2010 ->		
Ducato 140 Natural Power	2009 ->		
Grande Punto 1.4 16V	2005 ->		
Idea 1.2 16V	2004 ->		
Idea 1.4 16V	2004 ->		
Panda 1.4	2006 ->		



Ref. 80240

Suitable / Reemplaza:

- Audi-VW**
- 06F 905 115
- 06F 905 115 A
- 06F 905 115 B
- 06F 905 115 C
- 06F 905 115 D
- 06F 905 115 E
- 06F 905 115 F
- 06H 905 115
- 06H 905 115 A
- 07K 905 115 B
- 07K 905 715
- 07K 905 715 A
- 07K 905 715 B
- 07K 905 715 C

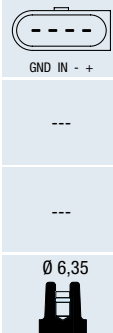
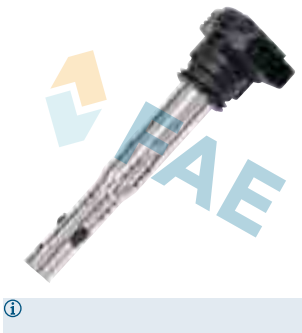

AUDI Cont.	
TT 2.0 quattro, Roadster	2008 ->
TT 2.0 TFSI	2010 ->
TT 2.0 TFSI quattro	2010 ->
TT 2.0 TFSI quattro Roadster	2010 ->
TT 2.0 TFSI quattro, Roadster	2008 ->
TT 2.0 TFSI Roadster	2010 ->
TT 2.0 TFSI, Roadster	2006-10
SEAT	
Alhambra 2.0 TSI	2010 ->
Altea 1.8 TFSI	2007 ->
Altea 2.0 FSI	2004-09
Altea 2.0 TFSI	2006-09
Altea XL 1.8 TFSI	2007 ->
Altea XL 2.0 FSI	2006-09
Altea XL 2.0 TFSI 4x4	2007-09
Exeo 1.8 TSI	2010 ->
Exeo 2.0 TFSI	2009 ->
Exeo ST 1.8 TSI	2010 ->
Exeo ST 2.0 TFSI	2009 ->
Leon 1.8 TSI	2007 ->
Leon 2.0 FSI	2005-10
Leon 2.0 TFSI	2005-06
Toledo III 2.0 FSI	2004-09
Toledo III 2.0 TFSI	2005-09
SKODA	
Octavia 1.8 TSI 4x4, Combi	2008 ->
Octavia 1.8 TSI, Combi	2007 ->
Octavia 2.0 FSI 4x4 Combi	2004 ->
Octavia 2.0 FSI, Combi	2004 ->
Octavia 2.0 RS, Combi	2005 ->
Superb 1.8 TSI	2008 ->
Superb 1.8 TSI 4x4	2008 ->

SKODA Cont.	
Superb 1.8 TSI 4x4 Kombi	2009 ->
Superb 2.0 TSI	2010 ->
Superb 2.0 TSI Kombi	2010 ->
Superb 3.8 TSI Kombi	2009 ->
Yeti 1.8 TSI 4x4	2009 ->
VOLKSWAGEN	
Eos 2.0 FSI	2006-08
Eos 2.0 TFSI	2006 ->
Eos 2.0 TSI	2009 ->
Golf Plus 2.0 FSI	2005-08
Golf V 2.0 FSI	2004-08
Golf V 2.0 FSI 4motion	2004-08
Golf V 2.0 GTI	2004-09
Golf V 2.0 Variant	2007 ->
Golf VI 1.8 TSI	2009 ->
Golf VI 2.0 R 4motion	2009 ->
Golf VI 2.0 TSI	2009 ->
Jetta III 2.0 FSI	2005-10
Jetta III 2.0 TFSI	2005-10
Jetta III 2.5 FSI	2006-10
New Beetle 2.5, Cabrio	2005 ->
Passat 1.8 TSI, CC, Variant	2007-10
Passat 2.0 FSI 4motion, Variant	2005-10
Passat 2.0 FSI, Variant	2005-10
Passat 2.0 TFSI, Variant	2005-10
Passat 2.0 TSI CC	2008 ->
Scirocco 2.0 R	2009 ->
Scirocco 2.0 TSI	2008-09
Sharan 2.0 TSI	2010 ->
Tiguan 2.0 TFSI 4motion	2007 ->
Touareg 4.2 V8 FSI	2006-10
Touran 2.0 FSI	2003 ->

AUDI	
A3 1.8 TFSI Cabrio	2008 ->
A3 1.8 TFSI quattro, Sportback	2008 ->
A3 1.8 TFSI, Sportback	2006 ->
A3 2.0 FSI	2003 ->
A3 2.0 FSI Sportback	2004 ->
A3 2.0 TFSI	2004 ->
A3 2.0 TFSI Cabrio	2008 ->
A3 2.0 TFSI quattro, Sportback	2004 ->
A3 2.0 TFSI Sportback	2004 ->
A3 S3 quattro, Sportback	2006 ->
A4 1.8 TFSI	2008 ->
A4 1.8 TFSI Avant	2008 ->
A4 1.8 TFSI quattro, Avant	2008 ->
A4 1.8 TFSI, Avant	2007 ->
A4 2.0 TFSI	2008 ->
A4 2.0 TFSI 16V Cabrio	2006-09

AUDI Cont.	
A4 2.0 TFSI Avant, quattro	2008 ->
A4 2.0 TFSI flexible fuel, Avant, quattro	2009 ->
A4 2.0 TFSI quattro, Allroad, Avant	2008 ->
A4 2.0 TFSI, Avant, quattro	2004-08
A4 RS4 quattro, Avant, Cabrio	2005-08
A4 S4 quattro	2008 ->
A5 1.8 TFSI, Cabrio, Sportback	2007 ->
A5 2.0 TFSI, Cabrio, quattro	2008 ->
A5 2.0 TFSI, Sportback	2008 ->
A5 2.0 TFSI, Sportback, quattro	2008 ->
A6 2.0 TFSI	2005-11
A6 2.0 TFSI Avant	2005-11
A6 2.4, Avant, quattro	2005-08
Q5 2.0 TFSI	2008 ->
Q5 3.2 FSI	2008 ->
TT 1.8 TFSI, Roadster	2008 ->

Ref. 80241

Suitable / Reemplaza:

- G.M.**
- 94404545
- 94853695
- Holden**
- 9091902164
- Isuzu**
- 8-94404-545-0
- Toyota**
- 90919-02164

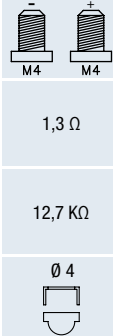

TOYOTA	
Avenis 1.6, Liftback, S.W.	1997-00
Camry 1.8 i	1986-88
Camry 1.8 S.W.	1986-88
Camry 2.0 Gili 16V, S.W.	1986-91
Camry 2.0 GLi Sedan	1983-86
Camry 2.0 Liftback	1986-88
Camry 2.0 Sedan	1986-88
Camry 2.0, S.W.	1986-91
Carina E 1.6 16V, Sedan	1994-97
Carina E 1.6 GLi, Sportswagon	1992-97
Carina E 1.6 i Sportswagon	1995-97
Carina E 1.6 Sedan	1987-92
Carina E 1.6, Sedan	1993-97
Carina E 1.8 GLi Sedan	1983-87
Carina II 1.6	1987-92
Carina II 1.6, Sedan, S.W.	1987-89

TOYOTA Cont.	
Carina II 1.6, Station Wagon	1987-92
Carina II 2.0 GLi, Sedan	1987-92
Carina II 2.0 S.W.	1987-92
Celica 1.6 STI Coupe	1989-94
Celica 1.6, Liftback	1986-90
Celica 1.8 i 16V	1993-99
Corolla 1.3	1984-87
Corolla 1.3 12V, Compact, Liftback,	1992-95
Corolla 1.3 12V, Wagon	1992-95
Corolla 1.3 i, Compact, S.W.	1989-92
Corolla 1.3 i, Liftback	1987-92
Corolla 1.3 XLI 16V, Compact, Wagon	1992-95
Corolla 1.3 XLI, Compact, Liftback,	1992-97
Corolla 1.3 XLI Wagon	1992-97
Corolla 1.3, Compact, S.W.	1987-89
Corolla 1.6	1983-87

TOYOTA Cont.	
Corolla 1.6 Aut., Compact, Liftback,	1997-00
Corolla 1.6 Aut., Wagon	1997-00
Corolla 1.6 GLi Liftback	1992-97
Corolla 1.6 Liftback	1983-87
Corolla 1.6 S.W.	1987-92
Corolla 1.6 Si, Compact, Wagon	1992-97
Corolla 1.6 XLI, 4x4, S.W.	1988-92
Corolla 1.6, Compact, Liftback	1989-92
Corolla 1.6, Compact, Liftback, S.W.	1987-89
Corolla 1.6, Compact, Liftback,	1997-00
Corolla 1.6, Wagon	1997-00
Corolla 1.8 16V 4WD Wagon	1995-97
Corolla 1.8 GT, Compact, Liftback	1992-95
Hiace III 2.0	1989-95
Hiace III 2.4, 4WD	1989-95
Hiace IV 2.4, 4WD	1995-98
Hilux 1.8 Pick-up	1988-94
Modell 1.8 De Luxe	1982-84
Modell F 2.0	1988-90
Modell F 2.0 Super	1984-88
Modell F 2.2	1987-90
Paseo 1.5 16V, Cabrio, Coupe	1995-99
Rav 4 I 2.0 16V, Cabrio	1994-00
Starlet 1.0	1989-92
Starlet 1.3	1984-89
Starlet 1.3 12V	1989-92

Ref. 80242

Suitable / Reemplaza:

- Toyota**
- 90080-19021
- 90919-02229
- 90919-02240
- 90919-T2003

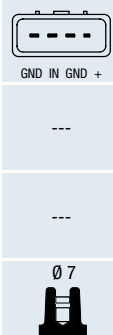

TOYOTA	
IQ 1.0	2009 ->
Prius 1.5 Liftback	2003 ->
Prius 1.5 Sedan	2000-04
Yaris 1.0 16V	1999 ->
Yaris 1.3	2002 ->
Yaris 1.3 16V	1999 ->
Yaris 1.3 Verso	1999 ->
Yaris 1.3 VWT-i	2006 ->
Yaris 1.5 TS	2003 ->
Yaris 1.5 Verso	2000 ->
Yaris 1.5 VWT-i TS	2001 ->



Ref. 80244

Suitable / Reemplaza:

Nissan 22448-4M500
22448-4M50A

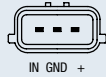

Ø 8



NISSAN			
Almera II 1.5, Fastback	2000 ->		
Almera II 1.8, Fastback	2000 ->		
Almera Tino 1.8	2000 ->		
Primera 1.6 16V, Fastback	1996-01		
Primera 1.6, Fastback	2002 ->		
Primera 1.8 16V, Fastback, Traveller	1999-01		
Primera 1.8, Fastback, Kombi	2002 ->		

Ref. 80245

Suitable / Reemplaza:

Hyundai 27301-02502

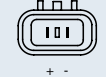

0,80 Ω

11 KΩ

Ø 8



HYUNDAI			
Atos 1.0 i, Prime	1998-02		

Ref. 80247

Suitable / Reemplaza:

BMW 1 712 219
1 712 223
12 13 1 712 219
12 13 1 712 223
12 13 7 523 345
12 13 7 548 553
12 13 7 550 012
12 13 7 551 049
Citroën V7.562.744.80
V7.571.643.80
Mini 12 13 7 550 012
12 13 7 571 643
Peugeot 5970.64
5970.91



0,54 Ω

Ø 8



BMW Cont.			CITROËN	
730 i	2008 ->		C3 II 1.4 VTi 95	2009 ->
730 i, Li	2005 ->		C3 II 1.6 VTi 120	2009 ->
730 i, Li	2003 ->		C3 Picasso 1.4	2009 ->
735 i, Li	2001 ->		C3 Picasso 1.6	2009 ->
740 i, Li	2005 ->		C4 1.4 VTi 95	2009 ->
745 i, Li	2001 ->		C4 1.6 THP 150, Coupe	2008 ->
750 i	2008 ->		C4 1.6 VTi 120	2009 ->
750 i xDrive	2009 ->		C4 1.6 VTi 120, Coupe	2008 ->
750 i, Li	2005 ->		C4 Grand Picasso 1.6 16V	2008 ->
760 i, Li	2003 ->		C4 Picasso 1.6 VTi 120	2008 ->
M3 3.2 Cabrio, Coupe	2000 ->		DS3 1.4 VTi 95	2010 ->
M3 CSL Coupe	2003 ->		DS3 1.6 VTi 120	2010 ->
X1 1.8 i sDrive	2010 ->		MINI	
X1 2.5 i xDrive	2010 ->		Mini Clubman Cooper	2007 ->
X1 2.8 i xDrive	2009 ->		Mini Clubman Cooper S	2007 ->
X3 2.0 i xDrive	2005 ->		Mini Clubman John Cooper Works	2008 ->
X3 2.5 i	2004 ->		Mini Clubman One	2010 ->
X3 2.5 i xDrive	2008 ->		Mini Cooper	2010 ->
X3 2.5 si	2006 ->		Mini Cooper Cabrio	2009 ->
X3 2.8 i xDrive	2011 ->		Mini Cooper S Cabrio	2009 ->
X3 3.0 i	2004 ->		Mini Cooper S, Cabrio	2006 ->
X3 3.0 i xDrive	2008 ->		Mini Cooper, Cabrio	2006 ->
X3 3.0 si	2006 ->		Mini Countryman Cooper	2010 ->
X5 3.0 i	2000 ->		Mini Countryman One	2010 ->
X5 3.0 i xDrive	2008-10		Mini One	2007 ->
X5 3.0 si	2007-08		Mini One Cabrio	2010 ->
X5 4.4 i	2000 ->		PEUGEOT	
X5 4.8 i	2007-08		207 1.4 16V, SW	2007 ->
X5 4.8 i xDrive	2008 ->		207 1.6 16V RC, SW	2007 ->
X5 4.8 is	2004 ->		207 1.6 16V Turbo, CC	2006 ->
X5 5.0 i xDrive	2010 ->		207 1.6 16V VTi, CC, SW	2007 ->
X5 M	2009 ->		308 1.4 16V	2009 ->
X6 3.5 i xDrive	2008 ->		308 1.4 16V SW	2009 ->
X6 5.0 i xDrive	2008 ->		308 1.4 16V, SW	2007 ->
X6 ActiveHybrid	2010 ->		308 1.6 16V CC	2009 ->
X6 M	2009 ->		308 1.6 16V, SW	2007 ->
Z3 M 3.2	2001-03		508 1.6 VTi	2010 ->
Z3 M 3.2 Coupe	2001-03		3008 1.6 VTi	2009 ->
Z4 2.0 i	2005 ->		5008 1.6 16V	2009 ->
Z4 2.2 i	2003 ->		ROLLS-ROYCE	
Z4 2.3 i sDrive	2009 ->		Ghost 6.6 V12	2008 ->
Z4 2.5 i	2003 ->		Phantom 6.75	2002 ->
Z4 2.5 si	2006 ->		Phantom 6.75 V12 Coupe	2007 ->
Z4 3.0 i	2003 ->		Phantom 6.75 V12 Drophead Coupe	2006 ->
Z4 3.0 i sDrive	2009 ->			
Z4 3.0 si, Coupe	2006 ->			
Z4 3.2 M, Coupe	2006 ->			
Z4 3.5 i sDrive	2009 ->			
Z4 3.5 is sDrive	2010 ->			
Z8 4.9	2000-03			

BMW		BMW Cont.	
1 3.0 Coupe	2011 ->	330 i Coupe	2006 ->
116 i	2004 ->	330 i Touring	2007 ->
118 i	2004 ->	330 i, Cabrio, Coupe	2006 ->
118 i, Cabrio	2007 ->	330 i, Touring	2000-05
120 i, Cabrio	2004 ->	330 xi, Coupe, Touring	2000 ->
125 i, Cabrio, Coupe	2007 ->	330 xi, Touring	2007 ->
130 i	2005 ->	335 i Cabrio	2007 ->
135 i Cabrio, Coupe	2007 ->	335 i xDrive, Coupe, Touring	2008 ->
316 Ci Coupe	2002 ->	335 i, Coupe, Touring	2006 ->
316 i, Touring	2002 ->	335 xi Coupe	2006 ->
316 ti Compact	2001-05	335 xi, Coupe, Touring	2007 ->
318 Ci Cabrio	2005 ->	520 i	2003 ->
318 Ci Cabrio, Coupe	2001 ->	520 i Touring	2004 ->
318 Ci Coupe	2005 ->	520 i, Touring	2000-03
318 i, Touring	2001-05	523 i, Touring	2005 ->
318 ti Compact	2001-05	525 i, Touring	2000-03
320 Ci Cabrio, Coupe	2000 ->	525 xi, Touring	2005 ->
320 i, Cabrio, Coupe, Touring	2006 ->	528 i	2010 ->
320 si	2006 ->	530 i Touring	2005 ->
323 i	2006-07	530 i, Touring	2000-03
323 i, Cabrio, Coupe, Touring	2006 ->	530 xi	2007 ->
325 Ci Cabrio, Coupe	2000 ->	530 xi, Touring	2005 ->
325 i Coupe, Touring	2005 ->	540 i	2005 ->
325 i, Cabrio	2005 ->	545 i, Touring	2003 ->
325 i, Cabrio, Coupe, Touring	2007 ->	550 i	2005 ->
325 i, Touring	2000-05	550 i Gran Turismo	2009 ->
325 ti Compact	2001-05	550 i Touring	2005 ->
325 xi	2005 ->	550 i xDrive	2010 ->
325 xi Coupe	2006 ->	550 i xDrive Gran Turismo	2010 ->
325 xi Touring	2005 ->	630 i, Cabrio	2004 ->
325 xi, Coupe, Touring	2007 ->	645 Ci, Cabrio	2004 ->
325 xi, Touring	2000-05	650 i	2011 ->
328 i	2005-07	650 i, Cabrio	2005 ->
330 Ci Cabrio, Coupe	2000 ->	7 ActiveHybrid	2010 ->



Ref. 80254

Suitable / Reemplaza:

Land Rover NEC000120L
NEC100730L
Rover NEC 000120
NEC 100730

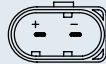

0,65 Ω

10,5 KΩ

Ø 8,2 Ø 4



LAND ROVER		ROVER	
Freelander 1.8 16V	2000 ->	25 1.1 16V	2004 ->
Freelander 1.8 i 16V, Soft Top	1998 ->	25 1.4 16V	1999 ->
MG		25 1.6 16V	1999 ->
MG TF 115	2002 ->	25 1.8 16V	1999 ->
MG TF 120	2002 ->	45 1.4	2000 ->
MG TF 135	2002 ->	45 1.6, Sedan	2000 ->
MG ZR 105	2001 ->	45 1.8, Sedan	2000 ->
MG ZR 120	2001 ->	75 1.8 , Tourer	1999 ->
MG ZS 120	2001 ->	75 1.8 Turbo, Tourer	2003 ->
MG ZT 1.8 16V	2003 ->	214 1.4i 16V Cabrio	1993-99
MG ZT 1.8 T 16V	2003 ->	214 GSi/Si	1992-95
MG ZT-T 1.8 16V	2003 ->	214 Si	1995-00
MG ZT-T 1.8 T 16V	2003 ->	414 GSi/Si Kat	1993-95
MGF 1.6	2000-02	414 Si	1995-00
MGF 1.8 i 16V	1995-02	416 Si	1995-00
		Streetwise 1.4	2003 ->

Ref. 80256

Suitable / Reemplaza:

Fiat 46777286
55180004



0,75 Ω



Ø 6,35



FIAT		
Doblo 1.6 16V	2001 ->	
Doblo 1.6 16V Cargo	2001 ->	
Multipla 1.6 16V	2002-10	
Multipla 1.6 16V Bipower	2001 ->	
Palio 1.6 16V Weekend	2001 ->	
Stilo 1.6 16V, Multi Wagon	2001 ->	

Ref. 80257

Suitable / Reemplaza:

G.M. 90543253
90560110
Opel 1208012

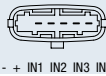

0,45 Ω

16 KΩ

Ø 4



OPEL		VAUXHALL
Agila 1.2 16V	2000 ->	
Astra G 1.2 16V Caravan	1998-00	
Astra G 1.2 16V CC	1998-00	
Astra G 1.2 16V Sedan	1998-00	
Corsa B 1.2 i 16V	1998-00	
Corsa C 1.2, Furgón	2000 ->	

Ref. 80259 **NEW**

Suitable / Reemplaza:

G.M. 90532618
90543059
93180806
Opel 1208028
1208306
24420622

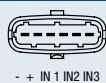

0,45 Ω

15,7 KΩ

Ø 3,5



OPEL		VAUXHALL
Agila 1.0	2003 ->	
Agila 1.0 12V	2000 ->	
Corsa B 1.0 i 12V	1996-00	
Corsa C 1.0	2000 ->	
Corsa D 1.0	2006 ->	
Corsa D 1.0 Van	2010 ->	



Ref. 80260

Suitable / Reemplaza:

Citroën 96.035.284
Peugeot 5970.45



①

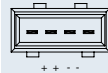

0,55 Ω

7 KΩ

Ø 6,35



CITROËN

AX 1.0	1986-98
AX 1.1	1986-94
AX 1.1 4x4	1991-92
AX 1.4	1988-92
AX 1.4 GTi	1991-92
AX 1.4, 4x4	1987-97
XM 2.0	1989-94
XM 2.0 Break	1989-94
XM 2.0 i, Break	1989-94
ZX 1.1	1991-93
ZX 1.4	1991-97
ZX 1.4 i	1991-97
ZX 1.4 i Break	1993-97
ZX 1.9 i	1991-97

PEUGEOT

106 I 1.0	1991-96
106 I 1.1	1991-96
106 I 1.4	1991-96
205 II 1.1	1989-98
205 II 1.4	1988-98
605 2.0	1989-99
Partner 1.4, Combispace	1996 ->

Ref. 80261

Suitable / Reemplaza:

G.M. 03474232
03474282
90449740
90510387
Opel 1208002
1208004
1208036
1208048

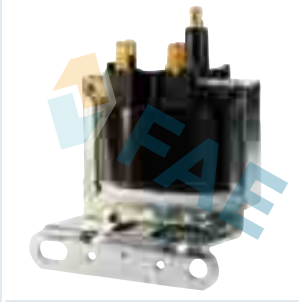

①

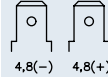

0,45 Ω

5,5 KΩ

Ø 6,35



OPEL Cont.

Kadett E 1.3 N, Caravan, Combo	1984-91
Kadett E 1.3 N, CC, Van	1984-89
Kadett E 1.3 S	1984-87
Kadett E 1.3 S Caravan	1984-87
Kadett E 1.3 S CC	1984-87
Kadett E 1.3 S, Cabrio, Combo	1986-89
Kadett E 1.4 i, Caravan, CC	1990-91
Kadett E 1.4 i, Cabrio, Combo	1990-91
Kadett E 1.6 i Kat, Cabrio, Caravan, CC	1986-91
Kadett E 1.6 i, Caravan, CC	1986-91
Kadett E 1.6 i, Combo, Furgón	1989-93
Kadett E 1.6 S, Caravan, CC, Combo	1986-91
Manta B 1.3 S	1981-86
Manta B 1.3 S CC	1979-86
Monza A 2.2 E	1984-86
Monza A 2.5 E	1984-86
Monza A 3.0 GSE	1978-86
Vectra A 1.6 i	1988-90
Vectra A 1.6 i Kat, CC	1988-95
Vectra A 1.6, CC	1988-93

VAUXHALL

OPEL	
Ascona B 1.3 N	1981-86
Ascona C 1.3 N CC	1981-86
Ascona C 1.3 S	1981-88
Ascona C 1.3 S CC	1981-88
Ascona C 1.6	1981-87
Ascona C 1.6 CC	1981-88
Ascona C 1.6 i	1987-88
Ascona C 1.6 i CC	1987-88
Ascona C 1.6 i Kat	1986-88
Ascona C 1.6 i Kat CC	1986-88
Astra F 1.6 i Van	1991-93
Astra F 1.6 i, Caravan, CC	1991-98
Corsa A 1.2 Furgón	1986-89
Corsa A 1.2 N CC	1990-93
Corsa A 1.2 S TR	1982-87
Corsa A 1.2 S, CC, Furgón, TR	1982-90

OPEL Cont.	
Corsa A 1.2 S, CC, TR	1982-90
Corsa A 1.3 Furgón	1986-89
Corsa A 1.3 i CC	1986-90
Corsa A 1.3 S TR	1982-87
Corsa A 1.3, CC, Furgón, S, TR	1982-89
Corsa A 1.3, Furgón, CC	1985-89
Corsa A 1.6 GSI CC	1988-92
Kadett D 1.2 S	1979-84
Kadett D 1.2 S Caravan	1979-84
Kadett D 1.3 N	1979-84
Kadett D 1.3 N Caravan	1979-84
Kadett D 1.3 S	1979-84
Kadett D 1.3 S Caravan	1979-84
Kadett E 1.3 i Kat	1985-91
Kadett E 1.3 i Kat Caravan	1985-91
Kadett E 1.3 i Kat, Caravan, CC	1985-91

Ref. 80262

Suitable / Reemplaza:

G.M. 03474233
90449739
90510386
Holden 90449739
Opel 1208003
1208054
1208070



①

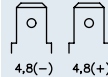

0,65 Ω

7 KΩ

Ø 4



OPEL Cont.

Vectra A 1.8 i Kat, CC	1990-95
Vectra A 1.8 S, CC	1988-90
Vectra A 1.8 S, CC, 4x4	1988-89

VAUXHALL

OPEL	
Astra F 1.4 i Classic, CC, Caravan,	1991-98
Astra F 1.4 i Classic, Van	1991-98
Astra F 1.4 i Van	1991-99
Astra F 1.4 Si, Cabrio, Caravan, CC	1992-98
Astra F 1.8 i, Caravan, CC	1991-98
Combo 1.2	1994-01
Combo 1.4	1994-01
Corsa A 1.2 i, CC, TR	1989-93
Corsa A 1.2, Furgón, CC	1982-90
Corsa A 1.4 i CC, TR	1990-93
Corsa A 1.4 i TR	1989-93
Corsa A 1.4 S, CC, TR	1990-93
Corsa A 1.4 Si CC	1991-93
Corsa A 1.6 GSI CC	1988-92
Corsa A 1.6 GSI Kat CC	1992-93
Corsa B 1.2 i	1993-00

OPEL Cont.	
Corsa B 1.4 i	1993-00
Kadett E 1.4 i, Cabrio, Caravan, CC,	1990-91
Kadett E 1.4 i, Combo	1990-91
Kadett E 1.4 S, Caravan, CC, Combo,	1989-91
Kadett E 1.4 S, Cabrio	1989-91
Kadett E 1.6 S	1984-86
Kadett E 1.6 S Caravan	1984-86
Kadett E 1.6 S CC	1984-86
Kadett E 1.6 S, Caravan, CC, Combo	1986-91
Kadett E 1.8	1987-90
Kadett E 1.8 i CC	1985-91
Kadett E 1.8 i, Caravan	1985-91
Omega A 1.8 S, Caravan	1986-94
Omega A 1.8, Caravan	1986-94
Vectra A 1.6 i Kat, CC	1988-95
Vectra A 1.6, CC	1988-93



Ref. 80263

Suitable / Reemplaza:

Citroën	93.010.513 97.530.780
Peugeot	5970.43



0,71 Ω

7,5 KΩ

Ø 6,35



PEUGEOT

205 I 1.1 CJ Cabrio	1989-94
205 I 1.4 CJ Cabrio	1989-94
205 I 1.4 CJ Kat Cabrio	1989-93
205 I 1.9 CTI Cabrio	1987-94
205 II 1.0	1987-98
205 II 1.1	1987-90
205 II 1.3 Rallye	1987-90
205 II 1.4	1987-89
205 II 1.4 Kat	1987-93
205 II 1.9 GTI	1987-94
205 II 1.9 GTI Kat	1987-94
309 I 1.4	1989-89
309 I 1.6	1985-88
309 II 1.1	1990-93
309 II 1.4	1989-93
309 II 1.9	1989-93
309 II 1.9 GTI	1989-93
405 I 1.4, Break	1987-92
405 I 1.9, Break	1988-92

CITROËN

AX 1.0	1986-92
AX 1.0 E	1986-88
AX 1.1	1986-94
AX 1.1 Kat	1988-89
AX 1.3 Sport	1987-88
AX 1.4	1986-88
AX 1.4, 4x4	1987-97
BX 11	1988-92
BX 14	1989-93
BX 14 Break	1989-93
BX 14 E	1982-88
BX 14, Break	1989-89
BX 16, Break	1988-93
BX 19 Gti, Break, 4x4	1988-93
BX 19 Kat Break	1986-94
C15 1.0	1984-97

CITROËN Cont.

C15 1.1	1984-96
C15 1.1 i	1988-96
C15 1.1 Kombi	1988-96
C15 1.4	1987-96
C15 1.4 E	1987-96
C15 1.4 i	1991-96
C15 1.4 Kombi	1991-96

Ref. 80264

Suitable / Reemplaza:

Chrysler	T1-031135
Renault	77 01 031 135
Volvo	3287677 3287677-3

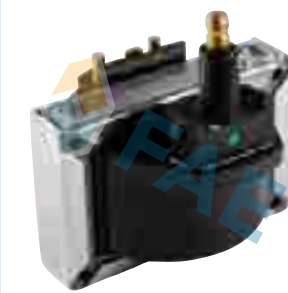

0,46 Ω

7,5 KΩ

Ø 6,35



RENAULT Cont.

Espace II 2.2	1991-96
Espace II 2.2 4x4	1991-96
Espace II 2.8 V6	1991-96
Express 1.4 Furgón	1985-91
Laguna 1.8	1993-01
Laguna 1.8, Grandtour	1995-01
Laguna 2.0, Grandtour	1993-01
Master 2.0	1985-89
Master I 28-35 2.0	1980-86
Master I 30 2.2	1980-98
Megane I 1.4 e, Classic	1996 ->
Megane I 1.4 Eco	1996-99
Megane Scenic 1.4 i	1997-99
Safrane I 2.0 12V	1992-96
Safrane I 2.2	1992-96
Safrane I 3.0 Biturbo 4x4	1993-96
Safrane I 3.0 V6, 4x4	1992-96
Safrane II 3.0 V6	1996-00
Super 5 1.4	1984-88
Super 5 1.4 Turbo	1985-90
Super 5 1.7	1986-95
Super 5 1.7 i	1986-91
Trafic 1.7	1986-89
Trafic 2.0	1980-86
Trafic 2.0 [RWD]	1989-97
Trafic 2.0 4x4	1986-89
Trafic 2.2	1989-94
Trafic 2.2 4x4	1989-94

ALPINE

A610 3.0 Turbo	1991-95
V6 2.5 Turbo	1985-90
JEEP	
Wrangler I 2.5	1988-91
RENAULT	
5 1.4	1982-85
9 1.4	1981-85
9 1.4 Automatik	1981-85
9 1.4 Turbo	1984-86
9 1.7	1984-88
11 1.2, Furgón	1984-88
11 1.4	1983-85
11 1.4 Turbo	1984-86
11 1.7	1983-87
18 1.4	1978-86
18 1.4 Variable	1979-86
18 1.6 Turbo	1982-86
18 1.6 Turbo Variable	1982-86
18 2.2 i	1984-86
19 I 1.4	1988-92
19 I 1.4 Chamade	1988-92
19 I 1.7 Cabrio	1991-92
19 I 1.7 Chamade	1988-92
19 I 1.7, Cabrio, Chamade	1988-92
19 I 1.7, Chamade	1988-92
19 I 1.8 16V, Cabrio, Chamade	1989-92
19 II 1.4	1992-95
19 II 1.4 Chamade	1992-94
19 II 1.4, Chamade	1992-95
19 II 1.7	1992-95
19 II 1.7 Chamade	1993-95
19 II 1.7, Cabrio, Chamade	1992-93
19 II 1.7, Chamade	1992-95
19 II 1.8	1992-95

RENAULT Cont.

19 II 1.8 16V, Cabrio, Chamade	1992-95
19 II 1.8 Cabrio, Chamade	1992-95
19 II 1.8 Chamade	1992-94
19 II 1.8, Cabrio, Chamade	1992-95
19 II 1.8, Chamade	1992-94
21 1.7 Kombi	1986-89
21 1.7 Sedan	1986-87
21 1.7, Kombi	1988-93
21 1.7, Kombi, Sedan	1986-88
21 2.0 Kombi	1991-93
21 2.0 Sedan	1991-93
21 2.0 Turbo Sedan, 4x4	1987-90
21 2.0, Kombi, Sedan	1986-88
21 2.0, Kombi, Sedan, 4x4	1986-93
21 2.2, 4x4, Kombi, Sedan	1986-93
21 2.2, Kombi, Sedan, 4x4	1989-94
25 2.0	1984-92
25 2.0 12V	1988-93
25 2.2	1984-89
25 2.4 V6 Turbo	1984-90
25 2.5 V6 Turbo	1990-92
25 2.8 V6	1987-90
25 2.8 V6 Injection	1986-88
Clio I 1.2	1990-96
Clio I 1.4	1991-98
Clio I 1.7	1991-93
Clio I 1.8	1991-98
Clio I 1.8 16V	1991-96
Clio I 1.8 Rsi	1993-95
Clio I Williams	1994-98
Espace I 2.0	1984-90
Espace I 2.0 i, Quadra	1988-92
Espace I 2.2, Quadra	1986-90
Espace II 2.0	1991-96

VOLVO

340-360 1.4	1975-83
340-360 1.4 Sedan	1983-86
340-360 1.4, Sedan	1986-88
340-360 1.7, Sedan	1985-91
340-360 2.0	1980-83
340-360 2.0 Sedan	1984-86
440 K 1.6	1988-96
440 K 1.7	1988-89
440 K 1.8	1991-96
440 K 2.0	1992-95
460 L 1.7	1988-96
460 L 1.8	1991-96
460 L 2.0	1992-95
480 E 1.7	1986-88
480 E 2.0	1992-95
850 2.0, Kombi	1991-96



Ref. 80265

Suitable / Reemplaza:
Fiat 7582152
 7663177
 7698431
 7746152
 7746154



0,46 Ω

7 KΩ

Ø 4



AUTOBIANCHI		FIAT Cont.	
Y10 1.0	1985 ->	Uno 45 i.e. 1.0	1984-95
Y10 1.0 4WD	1986 ->	Uno 50 1.1	1990-93
Y10 1.0 Kat	1987 ->	Uno 50 i.e. 1.1	1992-93
Y10 1.1 i.e. Kat	1990 ->	Uno 60 1.1	1985-89
Y10 1.1, 4WD	1989 ->	Uno 75 i.e. 1.5	1985-93
FIAT		LANCIA	
Panda 1000 i.e Van	1992-04	Y10 1.0 Fire, 4WD	1985-89
Panda 1000 i.e. Kat	1987-98	Y10 1.1 i.e	1989-92
Panda 1100, Trekking 4x4	1991-04	Y10 1.1 i.e 4WD	1989-92
Tempra 1.4 i.e., S.W.	1991-96	Y10 1.1 i.e. Fire, 4WD	1989-95
Tipo 1.1	1988-91		
Tipo 1.4	1987-89		
Tipo 1.4 i.e.	1989-95		
Uno 45 1.0	1986-93		

Ref. 80270 **NEW**

Suitable / Reemplaza:
Volkswagen 06A 905 097
 06A 905 104

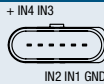



Ø 4



SKODA		VOLKSWAGEN	
Octavia 2.0 4x4 Combi	2000-04	Bora 2.0	1998-05
		Bora 2.0 4motion, Kombi	2000-05
		Bora 2.0 Kombi	1999-05
		Caddy III 2.0 EcoFuel	2006 ->
		Golf IV 2.0	1998-04
		Golf IV 2.0 4motion, Variant	2000-05
		Golf IV 2.0 Bi-Fuel Variant	2002-06
		Golf IV 2.0 Variant	1999-06
		New Beetle 2.0	1998 ->
		New Beetle 2.0 Cabrio	2002-10
		Touran 2.0 EcoFuel	2006-09

Ref. 80272 **NEW**

Suitable / Reemplaza:
Citroën 96.062.288
Peugeot 5970.49
Rover GCL 204
 NEC 100710

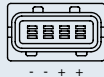

0,6 Ω

8 KΩ

Ø 4



CITROËN		PEUGEOT Cont.	
AX 1.0	1986-98	306 1.1	1993-01
AX 1.1	1986-97	306 1.4	1993-01
AX 1.4 GTi	1991-96	306 1.4 SL	1994-01
AX 1.4, 4x4	1987-97	306 1.6 SR, Break, Cabrio	1993-00
ZX 1.1	1991-97	405 II 1.4 Break	1992-96
ZX 1.4 i	1991-97	405 II 1.4, Break	1992-95
ZX 1.4 i Break	1993-97	ROVER	
PEUGEOT		400 2.0 i Tourer	1994-98
106 I 1.0	1991-96	420 Si Lux	1995-00
106 I 1.1	1991-96	620 Ti Vitesse	1994-99
106 I 1.3	1993-96	820 16V Turbo	1992-99
106 I 1.4	1991-96	820 I/Sl	1992-99
106 I 1.6	1993-96	820 Sport	1994-96
106 II 1.6 i	1996 ->	Mini MK I 1300	1991-91
205 II 1.0	1987-98	Mini MK I 1300, Cabrio	1992 ->
205 II 1.4	1990-98		

Ref. 80274 **NEW**

Suitable / Reemplaza:
Citroën 96.292.106
 9629210680
Fiat 5970.73
Peugeot 5970.A4



0,62 Ω

12,2 KΩ

Ø 6



CITROËN		PEUGEOT	
Evasion 2.0 16V	1998-00	306 1.8 16V, Break, Fastback	1997-01
Xantia 1.8 i 16V, Break	1995-98	306 2.0, Break, Cabrio	1997-01
Xantia 2.0 i 16V, Break	1995-98	406 1.8 16V, Break	1995-00
Xantia 2.0 i, Break	1998-03	406 2.0 16V, Break, Coupe	1995-04
XM 2.0 i 16V, Break	1994-00	605 2.0 16V	1994-99
Xsara 1.8 i 16V, Break, Coupe	1997-00	806 2.0 16V	1998-00
Xsara 2.0 16V, Break	1998-00		
ZX 1.8 i 16V, Break	1996-97		
FIAT			
Ulysse 2.0 16V	1998-00		
LANCIA			
Zeta 2.0 16V	1998-00		



Ref. 80275 **NEW**

Suitable / Reemplaza:

Peugeot 5970.75
5970.98

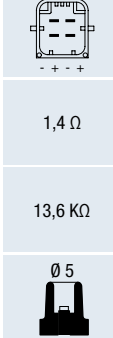

1,4 Ω

13,6 KΩ

Ø 5

CITROËN		PEUGEOT	
C4 2.0 16V, Coupe	2004 ->	206 2.0 S16	1999-00
C5 1.8 16V, Break	2001-04	206 2.0 S16, CC, SW	2000 ->
C5 2.0 16V, Break	2001-04	307 2.0 16V, Break, CC, SW	2000 ->
C8 2.0	2002 ->	406 1.8 16V, Break	2000-04
Evasion 2.0 16V	2000-02	406 2.0 16V, Break, Coupe	1999-00
Jumpy 2.0	2000-06	407 1.8, SW	2004 ->
Jumpy 2.0 i 16V, Furgón	2000 ->	407 2.0, SW	2004 ->
Xsara 2.0 16V, Break, Coupe	2000-05	607 2.0	2000 ->
Xsara Picasso 1.8 16V	2000 ->	806 2.0 16V	2000-02
Xsara Picasso 2.0 16V	2003 ->	807 2.0	2002 ->
		Expert 2.0	2000 ->

Ref. 80277 **NEW**

Suitable / Reemplaza:

Citroën 96.453.331.80
Peugeot 5970.84
5970.A5

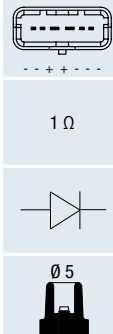

1 Ω

Ø 5

CITROËN		PEUGEOT	
C4 2.0 16V, Coupe	2004 ->	206 2.0 RC	2003 ->
C8 2.2	2002 ->	307 2.0 16V, Break, CC	2003 ->
		406 2.2, Break, coupe	2000-04
		407 1.8 16V, SW	2005 ->
		407 1.8, SW	2004 ->
		407 2.2 16V, Coupe, SW	2005 ->
		407 2.2, SW	2004 ->
		607 2.2 16V	2000 ->
		807 2.2	2002 ->

Ref. 80278 **NEW**

Suitable / Reemplaza:

Peugeot 5970.87
5970.A0

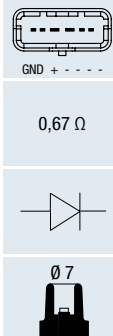

0,67 Ω

Ø 7

CITROËN		PEUGEOT	
C4 2.0 16V	2004 ->	307 2.0 16V, Break, CC, SW	2002 ->
C4 2.0 16V Sedan	2006 ->	407 2.0 16V, SW	2005 ->
C4 Grand Picasso 1.8 i 16V	2006 ->	807 2.0 16V	2005 ->
C4 Grand Picasso 2.0 i 16V	2006 ->	Expert 2.0 16V, Tepee	2007 ->
C4 Picasso 1.8 i 16V	2007 ->		
C4 Picasso 2.0 i 16V	2007 ->		
C5 1.8 16V, Break	2005 ->		
C5 2.0 16V	2004 ->		
C5 2.0 16V Break	2004 ->		
C5 2.0 16V, Break	2008 ->		
C8 2.0 16V	2005 ->		
Jumpy 2.0 i	2007 ->		

Ref. 80279 **NEW**

Suitable / Reemplaza:

Alfa Romeo 60558152
60586072
60809606
Fiat 60809606
7648797
Honda 30520-PDF-E00
30520-PDF-E01
Kia OK011-18-100
Land Rover ERR6045
ERR6566
Peugeot 5970.53
Renault 60 00 581 617
Rover ERR 6045
Volkswagen 048 905 105 1

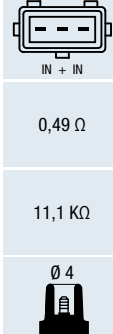

0,49 Ω

11,1 KΩ

Ø 4

FIAT Cont.		LAND ROVER	
Fiorino 75 i.e. 1.6	1993-01	Discovery II 4.0 V8	1998-04
Marea 1.2 16V, Weekend	1998 ->	Range Rover II 3.9	1994-02
Marea 1.4 80 12V, Weekend	1996 ->	Range Rover II 4.0	1998-02
Punto 1.2 16V 80	1999 ->	Range Rover II 4.6	1994-02
Punto 1.4 GT Turbo	1994-96	PROTON	
Scudo 1.6	1996 ->	Gen 2 1.3	2004 ->
Scudo 1.6 Combinato	1996 ->	Gen 2 1.6	2004 ->
Tempra 1.4 i.e., S.W.	1992-96	Satria 1.3	1996 ->
Tempra 1.6 i.e., S.W.	1992-96	Satria Neo 1.3	2007-08
Tipo 1.4 i.e.	1989-95	Satria Neo 1.6	2007 ->
Tipo 1.6 i.e.	1992-95	Wira 1.3	2000 ->
Uno 1.6 R	1992-95	Wira 1.3 Hatchback	2000 ->
FSO		Wira 1.5	2000 ->
Polonez III 1.6 i Sedan	1992 ->	Wira 1.5 Hatchback	2000 ->
HYUNDAI			
S 1.5 I Coupe Turbo	1991-96		
KIA			
Sportage 2.0 i 16V	1994-03		
Sportage 2.0 i 16V 4WD	1994-99		
LANCIA			
Dedra 1.6 i.e.	1993-99		
Delta II 1.4 i.e.	1994-99		
Delta II 1.6 i.e.	1993-99		
Kappa 2.0 16V Turbo, Coupe, SW	1995-01		
Thema 2000 16V Turbo, SW	1992-94		
Thema 2000 16V, SW	1992-93		
Thema 2000 i.e.	1987-92		
Thema 2000 i.e. 16V, SW	1989-92		
Y 1.2 16V	2000-03		
Y 1.4 12V	1996-03		
Y10 1.1 Avenue, 4WD	1995-95		
Y10 1.1 i.e. Fire, 4WD	1989-95		

ALFA ROMEO		FERRARI	
33 1.7 i.e., Sport Wagon	1992-94	348 TB 3.4	1990-93
145 1.6 i.e.	1994-96	348 TS 3.4	1990-93
145 1.7 i.e. 16V	1994-96	F355 3.5 Berlinetta	1994-99
146 1.6 i.e.	1994-96	F355 GTS 3.5 Spider	1994-99
146 1.7 i.e. 16V	1994-96	Mondial 3.4 T	1989-93
155 1.7 T.S.	1993-96	Mondial 3.4 T Cabrio	1989-93
155 1.7 T.S.	1993-96	FIAT	
155 1.8 T.S.	1992-93	Brava 1.2 16V 80	1998-00
155 1.8 T.S. Sport	1992-96	Brava 1.4	1995-01
155 2.0 T.S.	1992-93	Brava 1.4 12V	1995-98
155 2.0 T.S.	1992-95	Bravo I 1.2 16V 80	1998-00
164 2.0 T.S.	1992-98	Bravo I 1.4	1995-01
CITROËN		Croma 2000 16V	1992-96
Jumpy 1.6, 1.6 i	1995 ->	Fiorino 1.4 Pick-up	1994-01
DACIA		Fiorino 1.6 Pick-up	1994-01
Nova 1.6	1996-03	Fiorino 70 i.e. 1.4 Furgón	1994-01



Ref. 80280 NEW

Suitable / Reemplaza:

Fiat 46446039
46472440
46480361
500309816
7789346



①

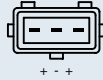

0,64 Ω

9 KΩ

Ø 4



FIAT	
Brava 1.6 16V	1995-01
Bravo I 1.6 16V	1995-01
Doblo 1.6 Natural Power	2002 ->
Doblo 1.6 Natural Power Cargo	2002 ->
Marea 1.6 100 16V Bipower	1999 ->
Marea 1.6 100 16V, Weekend	1996 ->
Multipla 1.6	2000 ->
Multipla 1.6 100 16V	1999 ->
Multipla 1.6 16V Bipower	1999 ->
Multipla 1.6 16V Blupower	1999 ->
Palio 1.6 16V Weekend	1996-01

LANCIA	
Dedra 1.6 16V, SW	1996-99
Delta II 1.6 i.e.	1996-99
Delta II 1.6 i.e. 16V	1996-99
Lybra 1.6 16V, SW	1999 ->

Ref. 80282 NEW

Suitable / Reemplaza:

Peugeot 5970.88
5970.CO
Toyota 90080-19015
90080-19019
90919-02239
90919-T2002



①

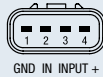



Ø 7



CITROËN	
C1 1.0	2005 ->

PEUGEOT	
107 1.0	2005 ->

TOYOTA	
Auris 1.4 VVTi	2007 ->
Avensis 1.6 VVT-i, Kombi, Sedan	2003 ->
Avensis 1.6 VVT-i, Liftback, S.W.	2000-03
Avensis 1.8 VVT-i, Liftback, S.W.	2000-03
Avensis 1.8, Kombi, Sedan	2003 ->
Aygo 1.0	2005 ->
Celica 1.8 16V VT-i	1999 ->
Corolla 1.4 VVT-i, Kombi, Sedan, Verso	2002 ->
Corolla 1.6 16V, Wagon	2000-02
Corolla 1.6 Verso	2004-09

TOYOTA Cont.	
Corolla 1.6 VVT-i Verso	2002-04
Corolla 1.6 VVT-i, Kombi, Sedan	2002 ->
Corolla 1.6, Compact, Liftback	2000-02
Corolla 1.8 Verso	2004-09
Corolla 1.8 VVT-i Verso	2002-04
MR 2 1.8 16V VT-i	2000 ->
Rav 4 II 1.8 VVT-i	2001 ->
Yaris 1.0	2011 ->
Yaris 1.0 VVT-i	2006 ->

Ref. 80284 NEW

Suitable / Reemplaza:

Ford 1350562
1350567
1458400
1459278
4M5G-12029-ZA
4M5G-12029-ZB
4S7G-12029-AA
4S7G-12029-AB
Mazda C401-18-100A
Volvo 30731416
30731419
31216444
31216444 AA



①

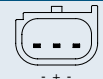

0,56 Ω

8,5 KΩ

Ø 4



MAZDA	
2 1.25	2003 ->
2 1.4	2003 ->
2 1.6	2003 ->

VOLVO	
C30 1.6	2006 ->
S40 II 1.6	2005 ->
V50 1.6	2005 ->

FORD		FORD Cont.	
C-Max 1.6	2007 ->	Focus III 1.6 Flexifuel, Sedan, Turnier	2011 ->
Fiesta 1.25 Van	2009 ->	Focus III 1.6 Sedan	2011 ->
Fiesta V 1.25 16V	2002 ->	Focus III 1.6 Ti, Sedan, Turnier	2011 ->
Fiesta V 1.4 16V	2001 ->	Focus III 1.6 Ti, Turnier	2011 ->
Fiesta V 1.6 16V	2001 ->	Fusion 1.25	2004 ->
Fiesta VI 1.25	2008 ->	Fusion 1.4	2002 ->
Fiesta VI 1.4	2008 ->	Fusion 1.6	2002 ->
Fiesta VI 1.4 LPG	2009 ->	Grand C-Max 1.6	2010 ->
Fiesta VI 1.6 Ti	2008 ->	Mondeo III 1.8 16V, Kombi, Sedan	2000-07
Focus C-Max 1.6	2003-07	Mondeo III 2.0 16V, Kombi, Sedan	2000-07
Focus C-Max 1.6 Ti	2004-07	Mondeo IV 1.6 Ti	2010 ->
Focus II 1.4, Sedan, Turnier	2004 ->	Mondeo IV 1.6 Ti Sedan	2007 ->
Focus II 1.6 Cabrio	2006 ->	Mondeo IV 1.6 Ti Turnier	2010 ->
Focus II 1.6 LPG, Turnier	2009 ->	Mondeo IV 1.6 Ti, Sedan, Turnier	2007 ->
Focus II 1.6 Ti, Sedan, Turnier	2004 ->	Mondeo IV 1.6 Ti, Turnier	2007 ->
Focus II 1.6, Sedan, Turnier	2004 ->		

Ref. 80285 NEW

Suitable / Reemplaza:

Ford 1317972
1319788
1319929
1619343
1S7G-12029-AC
1S7Z-12029-AA
988F-12029-AB
988F-12029-AD
988F-12029-BA
Mazda 1E05-18-100B
1F20-18-100
C201-18-100A
C201-18-100B
LF01-18-100



①

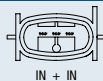

0,46 Ω

8,1 KΩ

Ø 4



FORD	
Fiesta 1.4 i Furgón	1996-99
Galaxy 2.0 i	1995-06
Galaxy 2.3 16V	1997-06
Ka 1.3 i, Van	1996-08
Mondeo III 1.8 16V, Kombi, Sedan	2000-07
Mondeo III 2.0 16V, Kombi, Sedan	2000-07

MAZDA	
3 2.0	2003 ->
3 2.0 Sedan	2004 ->
6 2.3	2002 ->
6 2.3 AWD Station Wagon	2002 ->
6 2.3 Hatchback	2002 ->
6 2.3 Station Wagon	2002 ->
Tribute 2.0 4WD	2000 ->



Ref. 80286 NEW

Suitable / Reemplaza:

Ford	1953302 1953306 F3XA-12029-AA F3XY-12029-A F5XZ-12029-AA
Nissan	22433-0B000 22433-0B001 22433-0B010 22433-51J10 22433-53J20 22433-55S10 22433-56E11 22433-56E12 22448-0C801

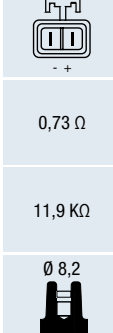

NISSAN Cont.			
Primera 2.0 i Traveller	1990-98		
Primera 2.0 i, Fastback	1995-96		
Serena 2.0 16V	1992-01		
Sunny II 1.6 i 12V, Coupe, Fastback	1986-90		
Sunny III 1.4 i	1990-95		
Sunny III 1.6 i	1990-95		
Sunny III 1.6 i 16V 4WD, Traveller	1990-95		
Sunny III 1.6 i Traveller	1991-00		
Sunny III 2.0 GTI 16V	1990-95		
Sunny III 2.0 GTI-R 4x4 Fastback	1990-95		
Terrano I 3.0 i 4WD	1990-95		
Terrano II 2.4 4WD	1996 ->		
Terrano II 2.4 i 12V 4WD	1993-96		
Vanette 1.6 i Cargo	1995 ->		

FORD		NISSAN Cont.	
Maverick 2.4 i	1993-96	Bluebird 2.0	1985-87
INFINITI		Bluebird 2.0 i Station Wagon	1984-90
G20 2.0	1990-97	Bluebird 2.0 i, Fastback	1984-88
M30 3.0, Cabrio, Coupe	1989-93	Maxima 3.0 i	1988-94
MAZDA		Micra 1.2	1986-92
323 III 1.3	1985-89	Pick Up 2.4 i 12V, 4WD	1992-98
323 III 1.3 Hatchback	1985-87	Prairie Pro 2.0 i, 4x4	1988-92
NISSAN		Prairie Pro 2.4 i, 4x4	1992-94
100 NX 1.6	1990-94	Primera 1.6 16V, Fastback, Traveller	1996-01
100 NX 1.6 SR	1993-94	Primera 1.6 16V, Traveller	1996-00
100 NX 2.0 GTI	1991-94	Primera 1.6 i Traveller	1990-98
200 SX 2.0 i 16V Turbo	1993-99	Primera 1.6, Fastback	1990-96
Almera I 1.4 GX, LX, Fastback	1995-00	Primera 2.0 16V, Fastback	1996-01
Almera I 1.4, Fastback	1995-00	Primera 2.0 16V, Fastback, 4x4	1990-96
Almera I 1.6	1995-00	Primera 2.0 16V, Traveller	1998-01
Almera I 1.6 SLX, SR, Fastback	1995-00	Primera 2.0 GT	1990-96

Ref. 80287 NEW

Suitable / Reemplaza:

Dacia	8200702693
Nissan	22462-00Q0A
Renault	82 00 702 693



DACIA			RENAULT	
Sandero 1.2 16V	2008 ->		Clio 1.2 16V Grandtour	2008 ->
NISSAN			Clio 1.2 16V Grandtour, Hi-Flex	2008 ->
Kubistar 1.2 16V	2006 ->		Clio II 1.2 16V	2001 ->
			Clio III 1.2 16V	2005 ->
			Clio III 1.2 16V, Hi-Flex	2005 ->
			Kangoo 1.2 16V	2001 ->
			Kangoo 1.2 16V Express	2001 ->
			Modus 1.2	2004 ->
			Modus 1.2, Hi-Flex	2004 ->
			Twingo 1.2 16V	2004 ->

Ref. 80288 NEW

Suitable / Reemplaza:

Nissan	22448-ED800
Renault	77 01 065 086

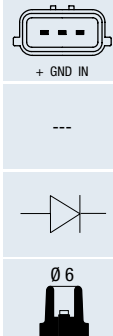

NISSAN			RENAULT	
Cube 1.6 16V	2010 ->		Clio III 2.0 16V	2006 ->
Micra C+C 1.6 160 SR	2005 ->		Laguna III 2.0 16V	2006 ->
Micra III 160 SR	2005 ->			
Note 1.6	2006 ->			
Qashqai 1.6	2007 ->			
Qashqai 2.0, Allroad	2007 ->			
Tiida 1.6, Sedan	2007 ->			
Tiida 1.8 Fastback, Sedan	2007 ->			
X-Trail 2.0	2007 ->			
X-Trail 2.0 FWD	2008 ->			

Ref. 80289 NEW

Suitable / Reemplaza:

G.M.	90443900 90449572
Opel	1208065

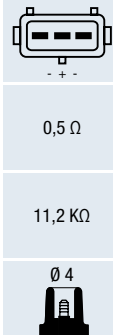

OPEL			VAUXHALL	
Astra F 2.0 GSI 16V, Caravan, CC	1991-98			
Calibra A 2.0 i 16V, 4x4	1990-94			
Frontera A 2.0 i Sport	1992-98			
Frontera A 2.2 i	1995-98			
Kadett E 2.0 Cabrio	1990-92			
Kadett E 2.0 GSI 16V Kat CC	1988-91			
Omega B 2.0	1994-00			
Omega B 2.0, Caravan	1994-99			
Sintra 2.2 i 16V	1996-99			
Vectra A 2.0 i 16V Kat CC	1990-95			
Vectra A 2000/GT 16V 4x4 Kat	1990-95			
Vectra A 2000/GT 16V Kat	1990-95			



Ref. 80291 NEW

Suitable / Reemplaza:

- Alfa Romeo 71739725
71744369
- Fiat 71739725
71744369
- G.M. 10458316
1104082
- Opel 1208021



①

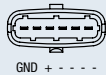

GND + - - - -

0,67 Ω



Ø 9,5



ALFA ROMEO	
159 1.8 MPI Sport Wagon	2007-11
159 1.8 TBI, Sport Wagon	2009-11
FIAT	
Croma 1.8 16V	2005 ->
Stilo 1.6 16V	2005 ->
OPEL	
Astra G 1.6 16V Coupe	2000-05
Astra G 1.6 Cabrio, Caravan, CC	2002-09
Astra G 1.6 Sedan	2002-05
Astra H 1.6 LPG Caravan	2009 ->
Astra H 1.6 Turbo, Caravan, GTC	2007 ->
Astra H 1.6, Caravan, GTC, Sedan	2004 ->
Astra H 1.8, Caravan, GTC, Sedan	2005 ->
Corsa D 1.6 Turbo	2007 ->

OPEL Cont.	
Insignia 1.6 Turbo	2008 ->
Insignia 1.6 Turbo Sedan	2009 ->
Insignia 1.6 Turbo Sports Tourer	2009 ->
Meriva 1.6	2006-10
Meriva 1.6 Turbo	2005-10
Signum 1.8	2005 ->
Vectra C 1.6, Caravan, GTS	2006 ->
Vectra C 1.8, Caravan, GTS	2006 ->
Zafira 1.6	2005 ->
Zafira 1.6 CNG Turbo, Van	2009 ->
Zafira 1.8	2005 ->
Zafira 1.8 Van	2005 ->
VAUXHALL	

Ref. 80293 NEW

Suitable / Reemplaza:

- Mercedes 000 158 77 03
160 158 77 03
- Smart (MCC) 0003100V003
0003100V004
0003100V005



①

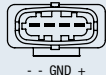

- - GND +

0,39 Ω



Ø 4



SMART	
Cabrio 0.6	2000-04
Cabrio 0.7	2003-04
City-Coupe 0.6	1998-04
City-Coupe 0.7	2003-04
Crossblade 0.6	2002 ->
Fortwo 0.7 Cabrio	2004 ->
Fortwo 0.7 Coupe	2004 ->
Roadster 0.7	2003 ->
Roadster 0.7 Brabus	2003 ->
Roadster 0.7 Brabus Coupe	2003 ->
Roadster 0.7 Coupe	2003 ->

Ref. 80294 NEW

Suitable / Reemplaza:

- Chrysler 5098138 AA
- Mercedes 000 158 73 03
000 158 78 03



①

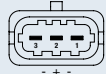

- + -

0,48 Ω



Ø 4



MERCEDES BENZ Cont.	
S 430 4-matic	2002-05
S 500	1998-05
S 500 4-matic	2002-05
S CL 55 AMG	1999-06
S CL 55 AMG Kompressor	2002-06
S CL 500 Coupe	1999-06
SL 55 AMG	2001-02
SL 55 AMG Kompressor	2002 ->
SL 280	1998-01
SL 320	1998-01
SL 350	2003 ->
SL 500	1998-01
SLK 32 AMG Kompressor	2001-04
SLK 55 AMG	2004 ->
SLK 320	2000-04
SLR 5.4	2004 ->
SLR 5.4 722 Edition	2006 ->
SLR 5.4 Roadster	2006 ->
Viano 3.2	2003 ->
Viano 3.7	2004 ->
Vito 119	2003 ->
Vito 119 Mixto	2003 ->
Vito 122	2003 ->
Vito 122 Mixto	2003 ->
Vito 123	2004 ->
Vito 123 Mixto	2004-08

CHRYSLER		MERCEDES BENZ Cont.	
Crossfire 3.2, Roadster	2003 ->	CLK 500, Cabrio	2002 ->
Crossfire SRT-6, Roadster	2004 ->	CLS 55 AMG	2005-10
MERCEDES BENZ			
A 150	2004 ->	E 55 AMG Kompressor, T	2002-08
A 160	2009 ->	E 55 AMG, T Kombi, 4-matic	1997-02
A 170	2004 ->	E 240	2002-08
A 180	2009 ->	E 240 4-matic, T	2003-08
A 200	2004 ->	E 240 T	2003-09
A 200 Turbo	2005 ->	E 240, T Kombi	1997-00
B 150	2005 ->	E 280, 4-matic, T Kombi	1996-02
B 160	2009 ->	E 320 4-matic, T	2003-08
B 170	2005 ->	E 320 4-matic, T Kombi	1996-03
B 170 NGT	2008 ->	E 320, T	2002-08
B 180	2009 ->	E 320, T Kombi	1996-03
B 180 NGT	2008 ->	E 430, T Kombi, 4-matic	1997-02
B 200	2005 ->	E 500 4-matic, T	2003-08
B 200 Turbo	2005 ->	E 500, T	2002-08
C 32 AMG Kompressor, T	2001 ->	G 320, Cabrio	1997 ->
C 43 AMG, Kombi	1997-00	G 500, Cabrio	1998 ->
C 55 AMG, T	2004 ->	G 55 AMG	1999 ->
C 230, Coupe	2005 ->	ML 55 AMG	2000-05
C 240	1997-00	ML 320	1998-02
C 240 4-matic, T	2002 ->	ML 350	2002-05
C 240 T	2001-07	ML 430	1998-05
C 240 T Kombi	1997-00	ML 500	2001-05
C 280	1997-00	ML 500 4-matic	2005 ->
C 280 T Kombi	1997-01	R 500 4-matic	2006 ->
C 320 4-matic	2002 ->	S 55 AMG	1999-05
C 320 4-matic T	2002-07	S 55 AMG Kompressor	2002-05
C 320, Coupe, T	2000 ->	S 280	1998-05
CLK 55 AMG, Cabrio	1999-02	S 320	1998-05
CLK 240, Cabrio	2002 ->	S 350	2002-05
CLK 320, Cabrio	1997-02	S 350 4-matic	2003-05
CLK 430, Cabrio	1998-02	S 430	1998-05



Ref. 80300 **NEW**

Suitable / Reemplaza:

- Honda**
- 30520-P8E-A01
 - 30520-P8F-A01
 - 30520-P8F-A02
 - 30520-PGK-A01
 - 30520-PVF-A01
 - 30520-RCA-A02



①



IN GND +

1,7 K Ω



\varnothing 8



HONDA			
Accord VII 3.0 V6 24V Coupe	1998-03		
Civic VII 1.4	2001-05		
Civic VII 1.4 i	2001-05		
Civic VII 1.4 iS	2001-05		
Civic VII 1.6, 1.6 i, Coupe, Sedan	2001-05		
Civic VII 1.7	2001-05		
Civic VII 1.7 i Coupe	2001-05		
Civic VII 1.7 i Vtec Coupe	2001-05		
FR-V 1.7	2005 ->		
Stream 1.7 16V	2001 ->		

Ref. 80301 **NEW**

Suitable / Reemplaza:

- Toyota**
- 90919-02247
 - 90919-02248
 - 90919-02260
 - 90919-A2001
 - 90919-C2002



①

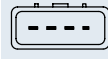

GND IN - +



\varnothing 8,5



TOYOTA			
Avensis 2.4, Kombi, Sedan	2003 ->		
Avensis Verso 2.4 WTi GLS	2003 ->		
Land Cruiser 4.0	2003 ->		
Previa 2.4 16V	2000 ->		

Ref. 80302 **NEW**

Suitable / Reemplaza:

- Volvo**
- 30713416
 - 9125601



①

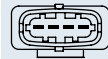

+ GND - IN

0,57 Ω



\varnothing 3,5



VOLVO Cont.			
V70 I 2.0 Turbo AWD Kombi	1997-00		
V70 I 2.0 Turbo Kombi	1997-00		
V70 I 2.3 Kombi T-5, AWD	1997-00		
V70 I 2.4 Kombi	1997-00		
V70 I 2.4 Turbo Kombi	1997-00		
V70 I 2.5 Kombi	1998-00		
V70 I 2.5 Turbo AWD Kombi	1997-00		
V70 II 2.0 T Kombi	2001 ->		
V70 II 2.3 T5 Kombi	2000 ->		
V70 II 2.4 Bifuel Kombi	2001 ->		
V70 II 2.4 Kombi	2000 ->		
V70 II 2.4 T Kombi, AWD	2000 ->		
V70 II 2.5 T Kombi, AWD	2002 ->		
XC70 2.4 T XC Cross Country AWD	2000-02		
XC70 2.5 T XC Cross Country AWD	2002 ->		
XC90 2.5 T	2002 ->		
XC90 T6	2002 ->		

VOLVO		VOLVO Cont.	
C70 I 2.0 T, Cabrio, Coupe	1997-02	S70 2.4 T5 AWD	1996-99
C70 I 2.3 T5 Cabrio	2002-05	S70 2.4 Turbo	1997-00
C70 I 2.3 T-5, Cabrio, Coupe	1997-02	S70 2.4, Blu-Fuel	1999-00
C70 I 2.4 T Cabrio	2002-05	S70 2.5	1998-00
C70 I 2.5 Coupe	1999-02	S80 2.0	1998-06
C70 I 2.5 T, Cabrio, Coupe	1997-02	S80 2.0 T	1998-06
C70 I 2.5, Cabrio, Coupe	1998-05	S80 2.4	1999-06
S60 2.0 T	2001 ->	S80 2.4 Bifuel	2001-06
S60 2.4	2000 ->	S80 2.4 T	2000-06
S60 2.4 Bifuel	2002 ->	S80 2.4 T5 AWD	2000-03
S60 2.4 T, AWD	2000 ->	S80 2.5 T, AWD	2003-06
S60 2.5 T, AWD	2004 ->	S80 2.8 T6	1998-06
S60 T5	2000 ->	S80 2.9	1998-06
S70 2.0 Turbo	1997-00	S80 3.0	2001-06
S70 2.3 T-5	1997-00	S80 3.0 T6	2001-06
S70 2.4	1997-00	V70 I 2.0 Kombi	1997-00

Ref. 80304 **NEW**

Suitable / Reemplaza:

- Ford**
- 1371601
 - 6M5G-12029-AA
- Volvo**
- 30713417
 - 8677837



①

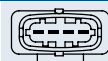

+ GND - IN



\varnothing 4



FORD			
Focus II 2.5 ST	2005 ->		
Kuga 2.5, 4x4	2009 ->		
Mondeo IV 2.5, Sedan, Turnier	2007 ->		
S-Max 2.5 ST	2006 ->		
VOLVO			
C30 2.4 i	2006 ->		
C30 T5	2006 ->		
C70 II 2.4 Cabrio	2006 ->		
C70 II 2.4 i Cabrio	2006 ->		
C70 II T5 Cabrio	2006 ->		
S40 II 2.4	2004 ->		
S40 II T5, AWD	2004 ->		
S60 2.0 T	2001 ->		
S60 2.4 T, AWD	2000 ->		
VOLVO Cont.			
S60 2.4 T5	2004 ->		
S60 R 2.5 T AWD	2003 ->		
S80 2.0 T	1999-06		
S80 II 2.5 T	2006 ->		
S80 II 2.5 T FlexFuel	2008 ->		
V50 2.4	2004 ->		
V50 T5, AWD	2004 ->		
V70 II 2.0 T Kombi	2001 ->		
V70 II 2.4 T5 Kombi	2004 ->		
V70 II R 2.5 T Kombi AWD	2003 ->		
V70 III 2.5 T FlexiFuel Kombi	2008 ->		
V70 III 2.5 T FlexiFuel, Kombi	2009 ->		
V70 III 2.5 T Kombi	2007 ->		



Ref. 80305 **NEW**

Suitable / Reemplaza:
Ford 6485688
 91XF-12029-AA
 91XF-12029-BA



0,5 Ω

11,9 KΩ

Ø 7



FORD			
Escort V RS 2000	1991-92		
Escort VI RS 2000, 4x4	1992-95		
Escort VII RS 2000, 4x4	1995-98		
Galaxy 2.3 16V	1997-06		
Scorpio II 2.0 i 16V, Kombi	1994-98		
Scorpio II 2.3 i 16V, Kombi	1996-98		
Transit 2.3 16V [RWD]	2000-06		

Ref. 80306 **NEW**

Suitable / Reemplaza:
Ford 6630365
 6958305
 919F-12029-AA
 E9SF-12029-AA
 E9SZ-12029-A



0,55 Ω

12,5 KΩ

Ø 7



FORD		FORD USA	
Cougar 2.5 ST 200	2000-01	Windstar 3.0 V6	1995-99
Cougar 2.5 V6 24V	1998-01		
Mondeo I 2.5 i 24V, Kombi, Sedan	1994-96		
Mondeo II 2.5 i 24V, Kombi, Sedan	1996-00		
Scorpio I 2.9 i 24V, Kombi, Sedan	1991-94		

Ref. 80307 **NEW**

Suitable / Reemplaza:
Mazda FFY1-18-100
 FP85-18-100C



13,3 KΩ

Ø 5



MAZDA			
323 F VI 1.9 16V	1998-01		
323 F VI 2.0	2001-04		
323 S VI 1.9 16V	1998-04		
323 S VI 2.0	2001-04		
Premacy 1.8	1999 ->		
Premacy 1.9	1999 ->		
Premacy 2.0	2001 ->		

Ref. 80309 **NEW**

Suitable / Reemplaza:
Citroën 96.330.015
 96.644.018
Fiat 9633001580
 9663278480
 9664401880
Peugeot 5970.77
 5970.94
Renault 77 01 479 027
 96 33 001 580
 96 64 401 880



0,63 Ω



Ø 3



CITROËN		PEUGEOT	
C5 3.0 V6	2004 ->	406 3.0 V6, Break, Coupe	2000-04
C5 3.0 V6 Break	2004 ->	407 3.0 V6, Coupe, SW	2004 ->
C5 3.0 V6, Break	2001-04	607 3.0 V6 24V	2000 ->
C6 3.0 V6	2005 ->	807 3.0 V6	2002 ->
C8 3.0 V6	2002 ->	RENAULT	
FIAT		Avantime 3.0 V6	2001-03
Ulysse 3.0 V6	2002 ->	Clio II 3.0 V6 Sport	2002 ->
LANCIA		Laguna II 3.0 V6 24V, Grandtour	2001 ->
Phedra 3.0 V6	2002 ->		

Ref. 80310 **NEW**

Suitable / Reemplaza:
Citroën 96.213.086
Peugeot 5970.56



0,55 Ω

12,8 KΩ

Ø 6



CITROËN		PEUGEOT	
Saxo 1.6	1996-04	106 II 1.6 S16	1996 ->
Saxo 1.6 VTS	1996-03		



Ref. 80312 NEW

Suitable / Reemplaza:
Fiat 46467542



0,7 Ω



Ø 4



FIAT		LANCIA	
Bravo I 2.0 HGT 20V	1998-01	Kappa 2.0 20V	1994-01
Coupe 2.0 20V	1998-00	Kappa 2.0 20V Turbo, Coupe, SW	1998-01
Marea 2.0 150 20V, Weekend	2001 ->	Kappa 2.0 20V, Coupe, SW	1996-01
Marea 2.0 155 20V, Weekend	1999-01	Kappa 2.4 20V	1994-01
		Kappa 2.4 20V Coupe, SW	1996-01
		Lybra 2.0 20V, SW	1999-00
		Thesis 2.0 Turbo	2002 ->
		Thesis 2.4	2002 ->

Ref. 80313 NEW

Suitable / Reemplaza:
Alfa Romeo 46469863



0,81 Ω

7,21 KΩ

Ø 4



ALFA ROMEO		ALFA ROMEO Cont.	
145 1.4 i.e. 16V T. S.	1996-01	Spider 1.8 16V	1998-05
145 1.6 i.e. 16V T. S.	1996-01	Spider 2.0 T. S. 16V	1995-05
145 1.8 i.e. 16V	1998-01		
145 2.0 16V Quadrifoglio	1998-01		
146 1.4 i.e. 16V T. S.	1996-01		
146 1.6 i.e. 16V T. S.	1996-01		
146 1.8 i.e. 16V T. S.	1998-01		
146 2.0 16V Quadrifoglio	1998-01		
156 1.6 16V T. S., Sportwagon	1997-05		
156 1.8 16V T. S., Sportwagon	1997-00		
156 2.0 16V T. S., Sport Wagon	1997-00		
166 2.0 T. S.	1998-00		
GTV 1.8 16V	1998 ->		
GTV 2.0 T. S. 16V	1995 ->		

Ref. 80315 NEW

Suitable / Reemplaza:

- Hyundai 27310-35010
27310-35020
- Kia KK137 18100
KK137 1810X
KK137 1810X C
KK370 1810X E
- Mitsubishi MD-158133
MD-160532
MD-166146
- Nissan 22433-12P01
22433-12P11
22433-V4410
22448-03E01
22448-03E11



0,78 Ω

11,8 KΩ

Ø 8,4



HYUNDAI		MITSUBISHI	
Galloper II 3.0 V6	1998 ->	Montero 2.4	1991-00
		Montero 2.4 Todo terreno abierta	1991-00
Pride 1.1 i	1991 ->	Sigma 3.0 Station Wagon	1993-96
Pride 1.3 16V	1990 ->	Sigma 3.0 V6	1990-96
Pride 1.3 i	1990 ->		
Pride 1.3 Kombi	1999 ->		
		NISSAN	
		Bluebird 1.8 Turbo	1984-90
		Bluebird 1.8 Turbo, Fastback	1985-90
		Sunny II 1.6 i, Coupe, Traveller, 4x4	1986-90

Ref. 80316 NEW

Suitable / Reemplaza:

- Hyundai 27301-38020
- Kia 27301 38020



23,4 KΩ

Ø 5



HYUNDAI		KIA	
Santa Fé 2.0	2001-06	Magentis 2.0	2001 ->
Santa Fé 2.4 16V, 4x4	2001-06	Sorento 2.4	2002 ->
Sonata IV 2.0 16V	1998-01		
Trajet 2.0	2000 ->		
Tucson 2.0, Allrad	2004 ->		



Ref. 80317 **NEW**

Suitable / Reemplaza:

- Chevrolet** 93363483
96253555
96566260
- Daewoo** 93363483
96253555
96566260



0,51 Ω

5,5 KΩ

Ø 4



CHEVROLET	DAEWOO
Aveo 1.2, Sedan	Evanda 2.0
Aveo 1.4 Sedan	Kalos 1.2
Aveo 1.5 Sedan	Kalos 1.4
Captiva 2.4 LPG	Kalos 1.4 16V, Sedan
Captiva 2.4 LPG 4WD	Kalos 1.4, Sedan
Captiva 2.4, 4WD	Lacetti 1.4 Fastback
Cruze 1.6	Lacetti 1.8 Fastback
Evanda 2.0	Lanos 1.4
Kalos 1.2, Sedan	Lanos 1.5 Sedan
Kalos 1.4 16V, Sedan	Matiz 1.0
Kalos 1.4, Sedan	Nubira 1.6 16V, Sedan, Wagon
Lacetti 1.8	Nubira 1.8 Kombi, Wagon
Matiz 1.0, LPG	Nubira 2.0 16V, Sedan, Wagon
Nubira 1.8 Kombi, Sedan	Tacuma 1.8
Tacuma 1.6	Tacuma 2.0
Tacuma 2.0	

Ref. 80318 **NEW**

Suitable / Reemplaza:

- Daewoo** 88921374
96350585
- G.M.** 10450424
10490192
- Opel** 1208051

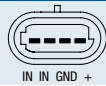

5,5 KΩ

Ø 4



CHEVROLET	HOLDEN
Tacuma 1.6	Frontera 2.2 i 4x4
Lanos 1.4	LADA 110 1.5 16V
Lanos 1.5	OPEL Frontera B 2.2 i
Lanos 1.5 Sedan	
Lanos 1.6 16V, Sedan	
Leganza 2.0 16V	
Nubira 1.6 16V, Sedan, Wagon	
Nubira 2.0 16V, Sedan, Wagon	

Ref. 80319 **NEW**

Suitable / Reemplaza:

- Daewoo** 96320818
96336522
94136766
- G.M.** 2243342L00
2243342L10
- Holden** AA100-18100B
8-94136-766-0
- Hyundai** AA100-18-100 B
- Isuzu** 22433-18R10
22433-42L10
- Kia** 22433-18R10
- Nissan** 22433-42L10
- Opel** 4294029



1,3 Ω

11,3 KΩ

Ø 8,2



DAEWOO	ISUZU
Matiz 0.8, Furgón	Trooper 2.3 Soft Top
Tico 0.8	

Ref. 80320 **NEW**

Suitable / Reemplaza:

- G.M.** 10457870
- Opel** 1208010

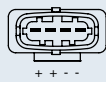

0,45 Ω

11 KΩ

Ø 4



OPEL
Astra G 1.6 Caravan
Meriva 1.6



Ref. 80324 NEW

Suitable / Reemplaza:

Mercedes 000 150 17 80
000 150 28 80



①





Ø 4



MERCEDES BENZ			
C 180 T Kombi	2000-01		
C 180, Coupe, T	2000-02		
C 200 Kompressor, Coupe, T	2000-02		
C 200 T Kompressor Kombi	2000-01		
C 230 Kompressor Coupe	2001-02		
CLK 200 Kompressor, Cabrio	2000-02		
CLK 230 Kompressor, Cabrio	2000-02		
E 200 Kompressor, T Kombi	2000-02		
SLK 200 Kompressor	2000-04		
SLK 230 Kompressor	2000-04		

Ref. 80325 NEW

Suitable / Reemplaza:

Mercedes 000 150 13 80



①



78,7 KΩ



Ø 5,5



MERCEDES BENZ			
A 140	1997-04		
A 160	1997-04		
A 190	1999-04		
A 210	2002-04		
Vaneo 1.6	2002 ->		
Vaneo 1.9	2002 ->		

Ref. 80326 NEW

Suitable / Reemplaza:

Seat 03D 905 115 F
03D 905 715 A

Skoda 03D 905 115 C
03D 905 115 D
03D 905 115 E
03D 905 115 F

Volkswagen 03D 905 115 A
03D 905 115 B
03D 905 115 C
03D 905 115 D
03D 905 115 E
03D 905 115 F
03D 905 115 G
03D 905 715 A



①



78,7 KΩ



Ø 5,5



SKODA		VOLKSWAGEN	
Fabia 1.2, Combi, Praktik, Sedan	2001-07	Fox 1.2	2005 ->
		Polo 1.2	2002-07

Ref. 80327 NEW

Suitable / Reemplaza:

Porsche 955 602 101 03
955 602 101 05

Seat 022 905 100 E
022 905 100 H
022 905 100 P

Skoda 022 905 715

Volkswagen 022 905 100 B
022 905 100 E
022 905 100 H
022 905 100 L
022 905 100 P
022 905 100 S
022 905 100 T
022 905 715



①





Ø 4



AUDI		VOLKSWAGEN Cont.	
A3 3.2 V6 quattro	2003 ->	Golf V 3.2 R32 4motion	2005-08
A3 3.2 V6 quattro Sportback	2004 ->	Multivan V 3.2 V6	2004-04
Q7 3.6 FSI	2006-10	Passat 3.2 FSI, 4motion, Variant	2005-10
TT 3.2 V6 quattro, Roadster	2006-10	Passat 3.6 4motion CC	2008-10
TT 3.2 VR6 quattro, Roadster	2003-06	Passat 3.6 FSI 4motion	2011 ->
PORSCHE		Passat 3.6 FSI 4motion Variant	2011 ->
Cayenne 3.2	2003 ->	Passat 3.6 R36 4motion, Variant	2007-10
SKODA		Phaeton 3.2 V6	2002 ->
Superb 3.6 V6 4x4	2008 ->	Phaeton 3.2 V6 4motion	2004 ->
Superb 3.6 V6 4x4 Kombi	2009 ->	Touareg 3.2 V6	2004-06
VOLKSWAGEN		Touareg 3.6 V6 FSI	2005-10
Eos 3.2 V6	2006 ->	Transporter V 3.2 V6	2003-04
Golf IV 3.2 R32 4motion	2002-05	Transporter V 3.2, 4motion, V6	2003-09
Golf V 3.2	2005-08		

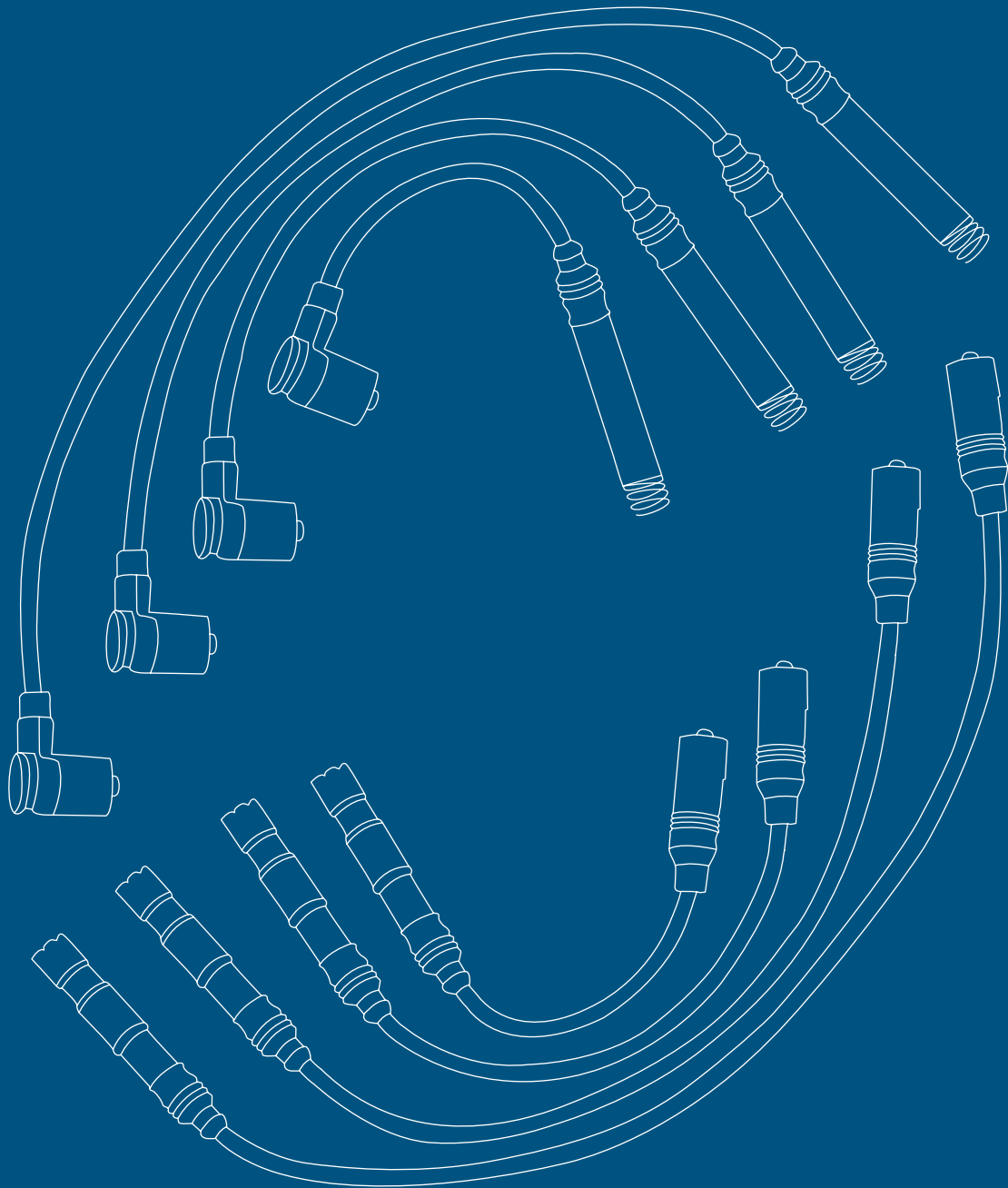

IGNITION LEADS
CABLES DE BUJÍAS
FAISCEAUX DE BOUGIES



EXAMPLES / EJEMPLOS / EXEMPLES

Ref. FAE

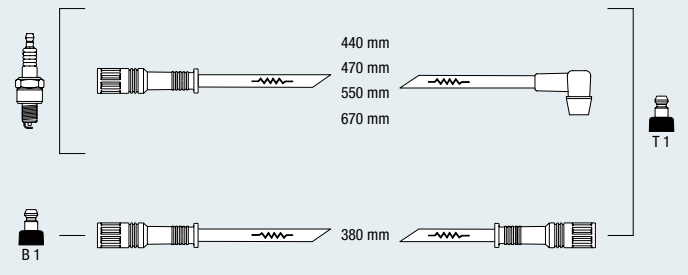

MAKER			
Model		Year	
FABRICANTE			
Modelo		Año	
CONSTRUCTEUR			
Modèle		Année	

Ref. 83490

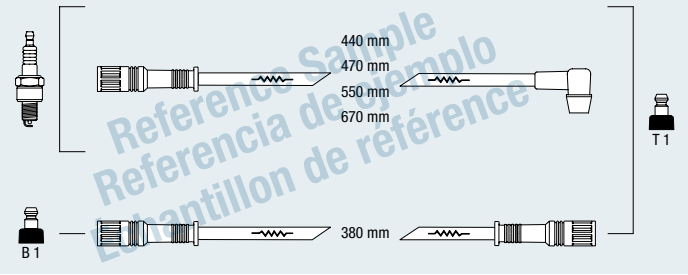

OPEL			VAUXHALL	
Ascona C 1.3		1983-87	Astra MKII 1.3	1984-88
Corsa 1.2, 1.3		1983-87	Belmont 1.3	1983-87
Kadett E 1.3		1983-87	Nova 1.2, 1.3	1983-87

SYMBOLS / SIMBOLOS / SYMBOLES

	CONNECTOR SAE Ø 6,3. CONECTOR SAE Ø 6,3. CONEXION SAE Ø 6,3.		1 CONNECTOR SAE Ø 6,3. CONECTOR SAE Ø 6,3. CONEXION SAE Ø 6,3.		5 CONNECTOR DIN Ø 5. CONECTOR DIN Ø 5. CONEXION DIN Ø 5.
	CONNECTOR M4. CONECTOR M4. CONEXION M4.		2 CONNECTOR Ø 4. CONECTOR Ø 4. CONEXION Ø 4.		RESISTANCE OF CABLE 920-1380 Ω/m. CABLE RESISTIVO 920-1380 Ω/m. CABLE À RESISTANCE 920-1380 Ω/m.
	DISTRIBUTOR CAP. TAPA DE DISTRIBUIDOR. TETE D'ALLUMEUR.		3 CONNECTOR DIN Ø 8,2. CONECTOR DIN Ø 8,2. CONEXION DIN Ø 8,2.		5 KΩ 5000 Ω SUPPRESSOR. SUPRESOR ANTIPARASITARIO 5000 Ω. SUPRESSEUR ANTI-PARASITE 5000 Ω.
	IGNITION COIL. BOBINA DE ENCENDIDO. BOBINE D'ALLUMAGE.		4 CONNECTOR ON COIL FORD. CONECTOR EN LA BOBINA FORD. CONEXION POUR BOBINE FORD.		1KΩ 1000 Ω SUPPRESSOR. SUPRESOR ANTIPARASITARIO 1000 Ω. SUPRESSEUR ANTI-PARASITE 1000 Ω.

LENGTH / LONGITUDES / LONGUEURS

Length in mm. of single ignition lead measured as shown:
Longitud en mm. de cada cable medido de la forma ilustrada:
Longeur en mm. de chaque fil de bougie mesuré comme suit:

The parts shown in this Catalogue, are subject to modification in design or material without notice.
Las piezas contenidas en este Catálogo, pueden estar sujetas a modificaciones dimensionales o de material, sin previo aviso.
Les pièces contenues dans ce Catalogue, peuvent être modifiées en matériel ou exécution sans préavis.

Refer to Vehicle Applications to trace the ignition cable set of a specific model.
Para identificar un juego de cables de encendido de un modelo específico, consultar Aplicaciones por Vehículos.
Pour trouver un modèle spécifique d'un jeu de cables, consulter les Applications par Vehicules.

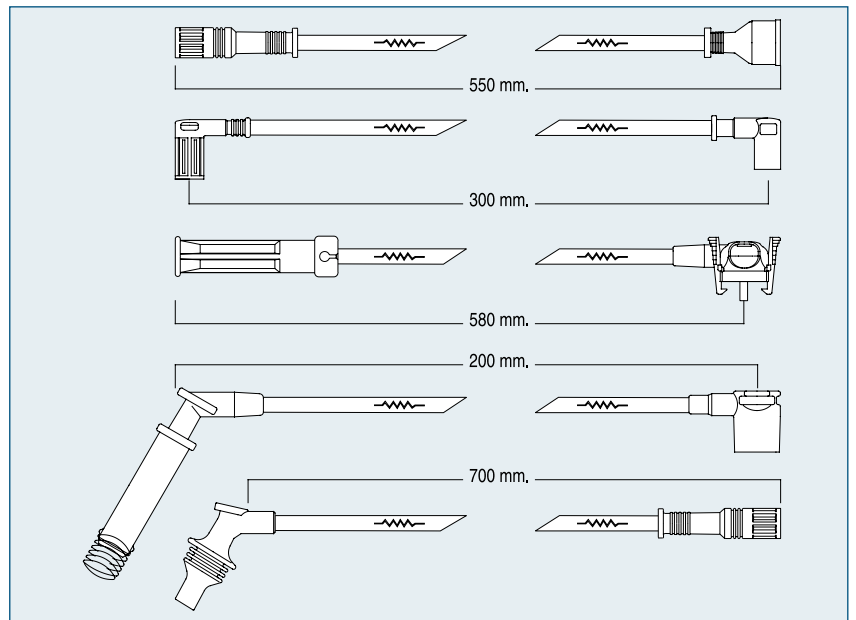

FITTING GUIDE / GUIA DE MONTAJE / GUIDE D'INSTALLATION

- Switch off the ignition, as high voltage electric shocks can cause severe injury. Then check to see that the spark plugs, distributor cap and coil are dry, clean and in good condition.
- Fit the new leads in the same sequence as the original leads, changing each lead in turn, one at a time commencing with the shortest.
- Then, push the lead firmly onto the spark plug to ensure a snug fit. Push the other end firmly into distributor cap or coil, to form a positive water tight fit. Always grip the moulded plug cap cover (fig. A), never the cable (fig. B).
- It is important to keep all loose leads away from any moving parts.

- Desconecte el encendido, puesto que los choques eléctricos de alta tensión pueden causar graves lesiones. Compruebe si las bujías, la tapa del distribuidor y la bobina están secas, limpias y en buen estado.
- Monte los nuevos cables en el mismo orden que los originales, cambiando cada uno por turno, empezando por el más corto.
- A continuación, empuje el cable firmemente en la bujía para asegurar un buen ajuste. Empuje el otro extremo firmemente a la tapa del distribuidor o a la bobina, para formar un ajuste hermético. Sujetar siempre el cable por la capucha (fig. A) nunca por el cable (fig. B).
- Es importante mantener todos los cables alejados de las piezas móviles.

- Coupez le contact, car les décharges électriques de haute tension peuvent occasionner des blessures sérieuses. Puis vérifiez que les bougies, le distributeur et la bobine sont secs, propres et en bon état.
- Installez les faisceaux de bougie neufs dans le même ordre que ceux qu'ils remplacent, en changeant chaque fil de bougie tour à tour, en commençant par le plus court.
- Puis poussez le fil de bougie fermement vers la bougie pour être sur qu'il est bien emboité. Poussez fermement l'autre bout dans le distributeur ou la bobine, afin d'obtenir un branchement qui soit bien étanche à l'eau. Saisissez le bouchon moulé de la bougie (fig. A), mais en aucun cas le câble lui-même (fig. B).
- Il est important que les faisceaux de bougie libres soient maintenus à l'écart des parties mobiles.

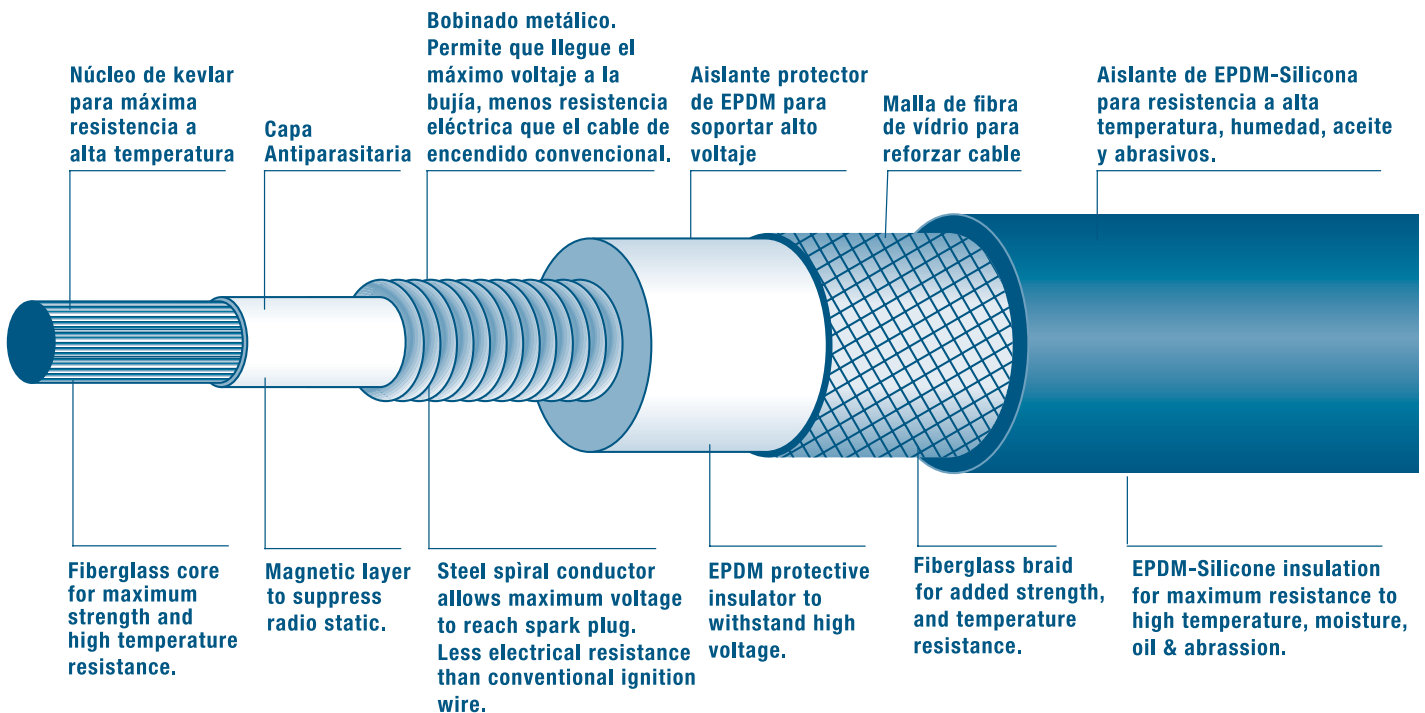
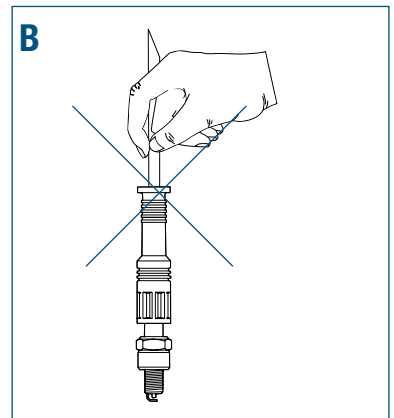
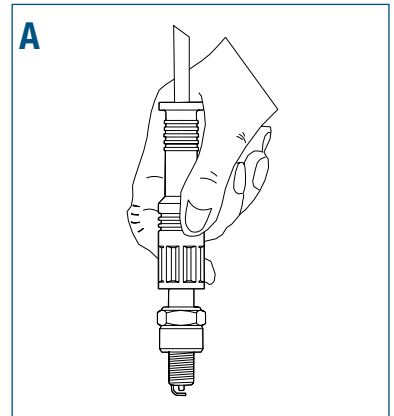

For further applications see
Para más aplicaciones consulte también
Pour déterminer les autres affectations veuillez vous référer à



Ref. 83010

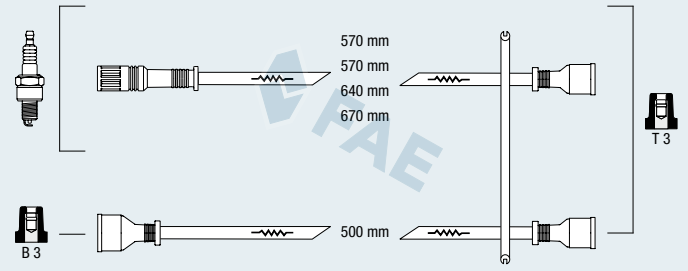

NISSAN		SEAT	
Cherry III 1.3	1982-86	133 0.8	1974-79
Cherry III 1.5	1983-86	600 D 0.8	1963-70
Micra 1.0	1982-89	850 0.9	1966-74
Pulsar 1.0	1982-88	1500	1957-72
Pulsar 1.3	1982-88		
Pulsar 1.6	1982-88		

Ref. 83020

Supplied up to exhausting stock / Suministrado hasta agotar existencias / Fourni jusqu'a épuisement du stock

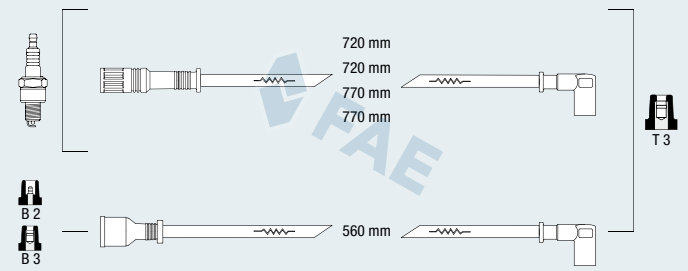

ALFA ROMEO		ALFA ROMEO Cont.	
33 1.3 i.e.	1983-89	Giulietta 1.3	1977-83
33 1.4 i.e., Sport Wagon, 4x4	1991-94	Giulietta 1.6	1977-85
33 1.5	1990-93	Giulietta 1.8	1979-85
33 1.5 i.e.	1990-91	GTV 1.6, 1.8, 2.0	1978-87
33 1.7 i.e., Sport Wagon, 4x4	1990-94	Spider 2.0 i	1991-93
75 1.8	1989-92	SAAB	
75 2.0 T. S.	1985-92	99 Turbo	1977-83
Alfetta 1.6, GT	1975-84	900 2.0, 2.0 i	1978-86
Alfetta 1.8	1979-84	900 Turbo	1979-83
Alfetta 1.8, GT	1974-76		

Ref. 83030

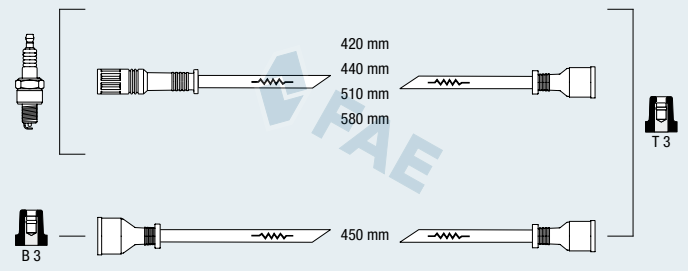

FIAT		SEAT Cont.	
Regata 60. 70. 80	1983-90	Panda 35. 40. 45	1980-87
SEAT		Panda Trans	1982-87
124 D, L, LS, DL, DLS	1968-80	Ritmo 65. 75. 75 CLX	1979-84
127. 127 Fura	1972-85	Ronda 65 CL. 75 CLX	1982-84
1430	1969-75	Terra 903 cc.	1987-91
1200 Sport	1976-80		
131 Mirafiori, Familiar	1975-81		
131 1430 Supermirafiori	1975-81		
Ibiza 903 cc.	1984-93		
Marbella 850-903 cc.	1987-91		

Ref. 83040

Supplied up to exhausting stock / Suministrado hasta agotar existencias / Fourni jusqu'a épuisement du stock

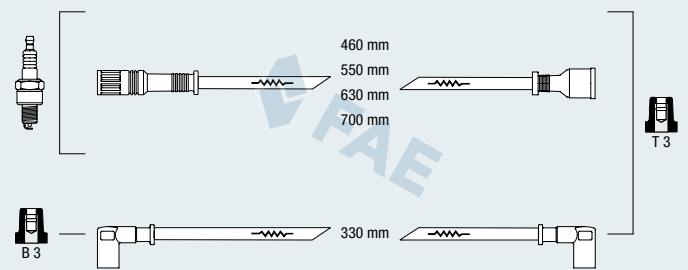

FIAT		LANCIA	
Tempra 1.8 ie SX, Break	1990-96	Dedra 1.8 ie, 2.0 ie	1989-94
Tipo 1.8 ie SX (AGT,DGT)	1990-96	Dedra 2000 ie Turbo Cat.	1989-92
Tipo 2.0 ie	1990-96	Dedra 2000 Turbo, 4WD	1991-94
UNO 70 SX ie 1372	1989-93	Dedra Automatics	1989-91
UNO 75 ie 1498	1989-93	Delta 1.6 ie GT Cat.	1987-93
		Delta 4WD Evoluzione	1992-94
		TALBOT-CHRYSLER	
		Samba GL, LS, S	1981-86

Ref. 83050

Supplied up to exhausting stock / Suministrado hasta agotar existencias / Fourni jusqu'a épuisement du stock

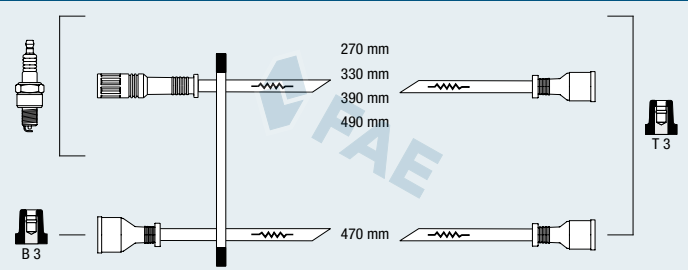

FIAT		SEAT	
Regata 60. 70. 80	1983-90	124 D, L, LS, DL, DLS	1968-80
		1430	1969-75
		1200 Sport	1976-80
		131 Mirafiori, Familiar	1975-81
		131 1430 Supermirafiori	1975-81
		Ritmo 65. 75. 75 CLX	1979-84
		Ronda 65 CL. 75 CLX	1982-84

Ref. 83060

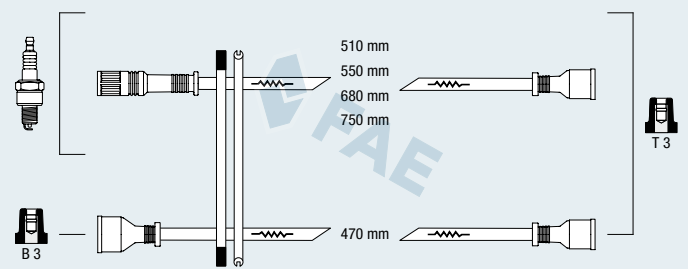

FIAT		SEAT	
124 1600 Special T	1973-75	124 D Especial, Sport	1970-79
124 1600 Sport Spider	1969-74	124 1600, 1800	1970-79
124 1800 Sport Coupe	1973-76	1430 1600, 1800	1973-75
Regata 100 1.6	1984-86	128	1976-80
Regata 100 1.6 Super	1983-90	131 1600, 1800, 2000	1975-84
		132 1600, 1800	1973-82

**Ref. 83080**

Supplied up to exhausting stock / Suministrado hasta agotar existencias / Fourni jusqu'a épuisement du stock

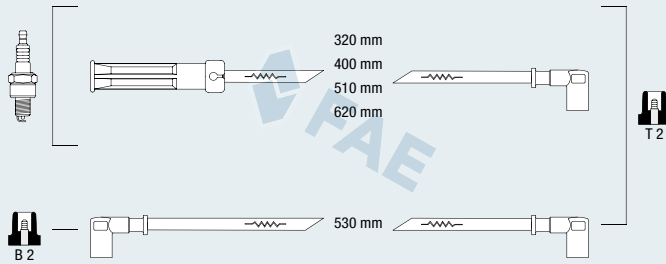

VOLVO			
Series 700	1988-90		
740, 740 Turbo	1987-90		
760 GLE, 760 Turbo	1983-90		
940 2.3	1990-91		
940 2.3 Kombi	1990-91		
Engines/Motores/Moteurs:			
B200/B230/Turbo.			

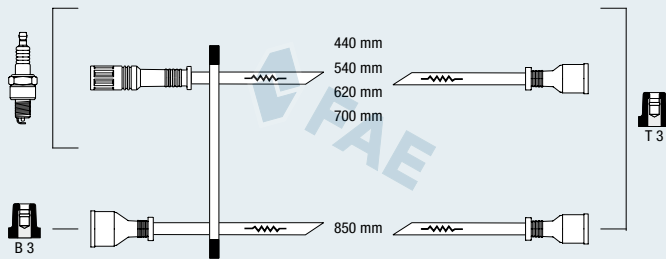
Ref. 83100

FIAT			LADA Cont.	
Argenta 2.0 ie	1981-85		Samara 1100, Forma	1991 ->
132 1.6 (A.A.)	1977-82		Samara 1300	1991 ->
2000 Spider Europa	1980-86		Samara 1300 Forma	1990 ->
LADA			Samara 1300, Forma	1986-94
110 1.5	1995 ->		Samara 1500, Forma	1988 ->
Natacha 1.5 68 cv.	1991 ->		Toscana 1.4	1986-93
Niva 1600 4WD	1976-95		Toscana 1500	1983-93
Nova 1500 S	1989 ->		SEAT	
Sagona 1.5	1991 ->		Ritmo Crono	1983-84
Samara 1100	1988-94		Ronda 100, Crono	1982-84

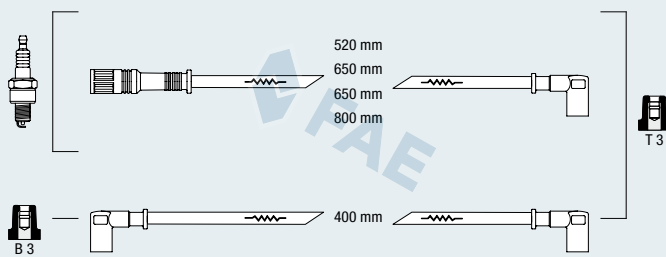
Ref. 83110

FIAT			SEAT	
Tempra Automatics	1990-93		Ibiza 1.2, 1.5	1984-93
Tipo Automatics	1990-93		Ibiza 1.5 i, 1.5 SXI	1984-93
LADA			Malaga 1.2, 1.5, Injection	1985-91
Samara 1.1, 1.3, 1.5	1986-94		Ronda 1.2 L, GL, GLX	1984-86
LANCIA				
Dedra Automatics	1991-94			
SAAB				
900 Turbo Serie HPC	1982-84			

Ref. 83120

Supplied up to exhausting stock / Suministrado hasta agotar existencias / Fourni jusqu'a épuisement du stock

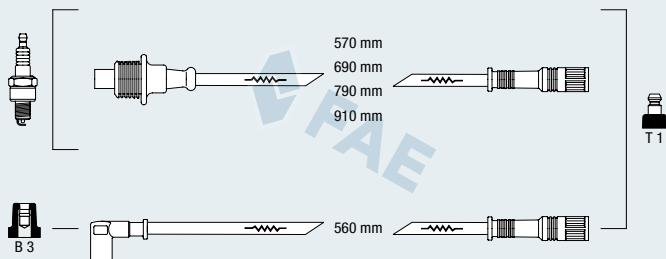

PEUGEOT			
205 I 1.9 GTI	1986-87		
205 II 1.9 GTI	1987-89		
205 II 1.9 GTI Kat	1987-94		
309 I 1.9 GTI	1986-89		
405 I 1.9	1987-93		
Engines/Motores/Moteurs:			
XU9JA.			

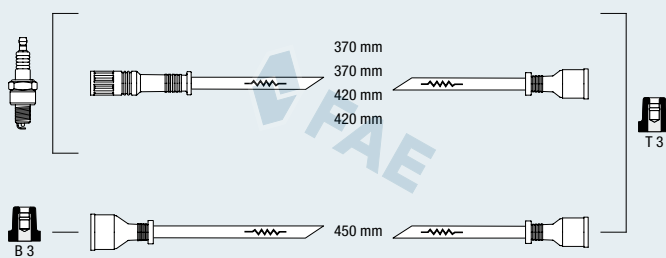
Ref. 83140

FIAT			RENAULT	
Duna 60 1.1, Weekend	1987-91		4 0.8	1962-83
Duna 70 1.3, Weekend	1987-91		4 0.8 Furgón	1966-88
Fiorino 1.0	1986-88		4 1.1 Furgón	1976-89
Fiorino 1.1, 60, Pick-up	1986-88		5 0.8	1982-84
Fiorino 1.3 Pick up	1987-94		5 1.1	1980-85
Fiorino 60 1.1 Furgón	1988-93		5 1.3, Automatic	1975-84
Fiorino 70 1.3	1988-94		18 1.4	1978-86
Fiorino 900	1977-84		18 1.4 Variable	1979-86
INNOCENTI			18 1.6 Turbo	1982-86
Elba 1.3	1991 ->		18 1.6 Turbo Variable	1982-86

Ref. 83150

Supplied up to exhausting stock / Suministrado hasta agotar existencias / Fourni jusqu'a épuisement du stock

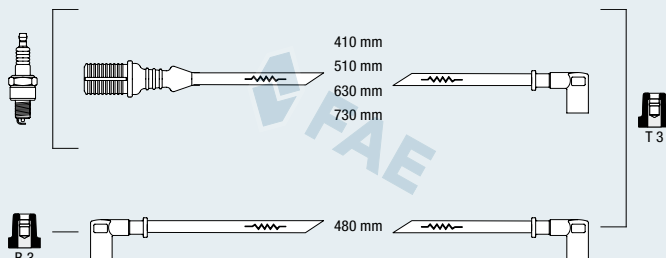

PEUGEOT			RENAULT	
505 2.0 TI,STI	1979-86		R-18 2.0 GTX, TS, (J6R)	1980-87
505 2.2 GTI	1983-93		R-20 2.0 (R1279)	1978-84
505 2.2 GTI Break	1985-86		Fuego 1.6 (843)	1980-86
505 2.2 Turbo Injection	1984-88		Fuego TX, GTX, 1995 cc.	1980-86
			Fuego 2.0 (J6R) ->13010	1980-86



Ref. 83160

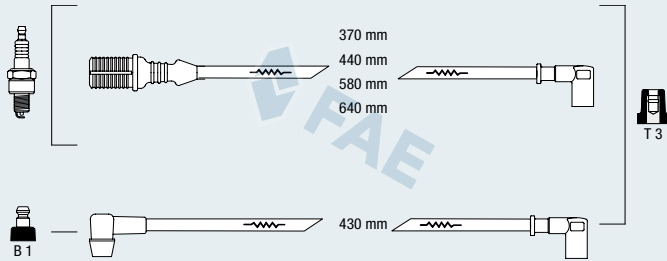

RENAULT			
R-21 GTX, RX, TXE, TI	1986-92		
R-25 TS, GTS, GTX, TX	1984-92		
Espace 2.0 i, 2.2 i	1987-90		
Trafic 2.0 [RWD]	1989-97		
Trafic 2.2	1989-94		
Trafic 2.2 4x4	1989-94		

Ref. 83170

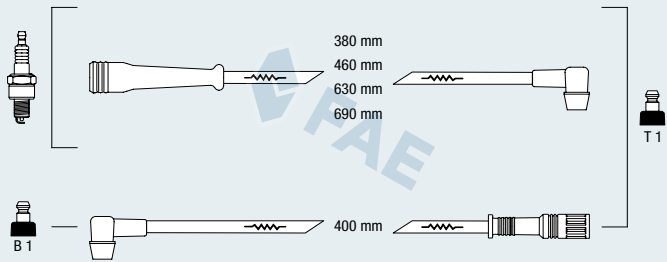

RENAULT		RENAULT Cont.	
Clio 1.2 (E5F)	1990-92	R-19 1.4 e (E7J)	1989-95
Clio 1.2 e (E7F)	1990-96	Scenic 1.4 i (E7J)	1997-99
Clio 1.4 (E6J)	1990-92		
Clio 1.4 e (E7J)	1990-96		
Express 1.4 (E6J)	1991-92		
Express 1.4 i (E7J)	1991-96		
Megane 1.4 e (E7J)	1995-99		
R-19 TS, GTS, TSE	1989-92		
R-19 1.2 e (E7F)	1989-95		
R-19 1.4 (E6J)	1989-92		

Ref. 83190

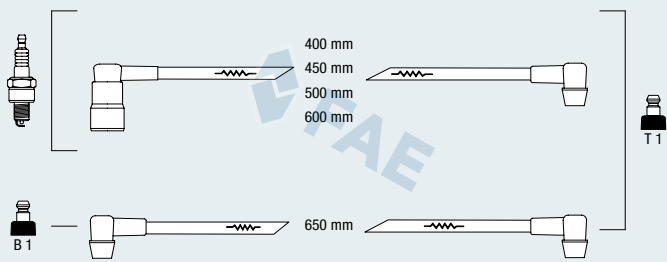

RENAULT		VOLVO	
Clio 1.7 RT, Bacc. (F2N)	1990-96	340 1.7 (B18)	1985-91
R-19 1.7 i (F3N-746)	1989-92	440 (B18E, B18F)	1988-92
R-19 1.7 RT (F2N)	1992-95	440 1.7 GL, GLS, GLT	1988-96
R-21 TS, GTS. (F2N)	1992-94	440 2.0	1993-96
		460 1.7 GL, GLE, Injection	1990-96
		460 2.0	1993-96
		480 1.7 ES, Injection	1986-90
		480 1.7, 1.8	1990-96

Ref. 83200

Supplied up to exhausting stock / Suministrado hasta agotar existencias / Fourni jusqu'a épuisement du stock

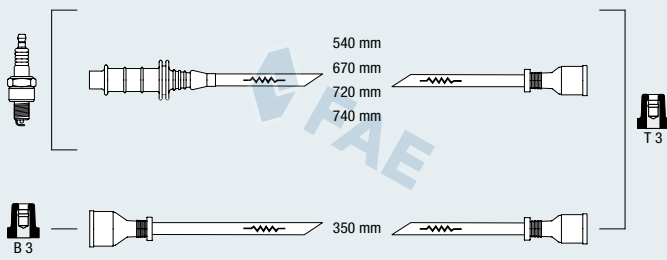

RENAULT			
R-14	1980-84		

Ref. 83210

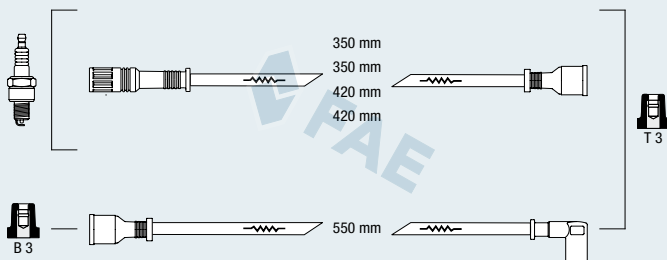

RENAULT Cont.		VOLVO	
18 1.6 4x4 Variable	1983-86	66 DL 1.1 Kombi	1975-79
18 1.6 TS	1982-86	66 GL 1.3	1975-78
18 1.6 TS Variable	1982-86	66 GL 1.3 Kombi	1975-79
18 1.6 Turbo	1980-82	140 1.8	1966-68
18 1.6 Variable	1979-82	140 1.8 S	1967-72
20 1.6	1975-77	140 2.0	1968-74
Clio I 1.1, Furgón	1991-98	140 2.0 S	1968-72
Express 1.0 Furgón	1986-92	140 2.0 S Kombi	1968-74
Express 1.1 Furgón	1987-91	P 122 S Amazon 1.8	1959-67
Express 1.2 Furgón	1991-98	P 122 S Amazon 1.8 Kombi	1961-67
Express 1.4 Furgón	1988-98	P 122 S Amazon 2.0	1968-71
Fuego 1.4 TL/GTL	1980-85		
Fuego 1.6	1983-85		
Fuego 1.6 TS/GTS	1980-85		
Fuego 1.6 Turbo	1983-85		
Super 5 1.0	1984-88		
Super 5 1.1	1984-88		
Super 5 1.2	1987-90		
Super 5 1.4	1985-96		
Trafic 1.4	1980-89		

DAIHATSU		RENAULT Cont.	
Charmant 1.3	1981-87	9 1.1	1981-87
NISSAN		9 1.2	1985-88
Cherry II 1.0 Hatchback	1978-81	9 1.4	1981-88
Cherry II 1.2 Coupe	1978-81	9 1.4 Automatik	1981-85
Cherry II 1.2 Hatchback	1978-81	11 1.1	1983-86
Cherry II 1.2 Traveller	1978-81	11 1.2, Furgón	1984-88
Vanette 1.5	1983-87	11 1.4	1983-85
RENAULT		17 1.6	1972-80
5 0.8	1982-84	17 1.6 Gordini	1974-80
5 1.0	1972-85	18 1.4	1978-86
5 1.4	1982-85	18 1.4 Variable	1979-86
5 1.4 Alpine Turbo	1981-85	18 1.6	1978-82

TOYOTA			
Hiace I 1.6 Furgón	1977-83		
Hiace I 1.6 Wagon	1979-84		

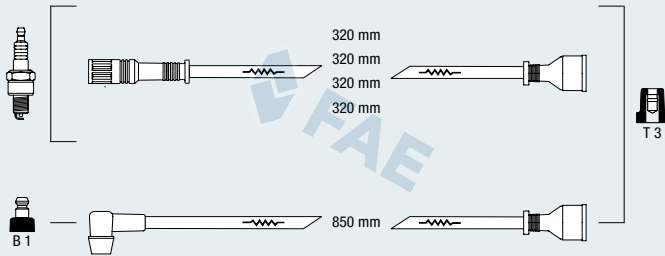
**Ref. 83220**

RENAULT		TOYOTA	
R-9 1.2, 1.4	1981-88	Cressida 2.0 S.W.	1977-81
R-11 1.2, 1.4, Turbo	1981-88	Cressida 2.0 Sedan	1977-81
R-19 1.2 RL	1992-95	VOLVO	
R-19 1.4 RL, RN	1992-95	340 L 1397 cc.	1976-91
Clio 1.108 cc.	1990-93		
Express 1.2, 1.4	1985-91		
Super 5 1.2, 1.4, Turbo	1985-90		
		Electronic Coil / Bobina Electrónica:	
		RENIX AEI.	

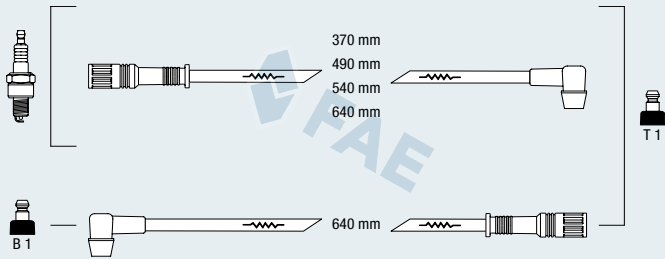
Ref. 83230

RENAULT			
R-9 TX, GTX, TXE. (F2N)	1984-88		
R-11 TX, GTX, TXE. (F2N)	1984-88		
R-19 GTX, TXE. (F2N,F3N)	1989-92		
R-21 (F2N, F2R, F3N)	1986-92		
Super 5 GTX (F2N)	1987-90		
Trafic 1.7 (F1N)	1987-89		
Engines/Motores/Moteurs:			
1721cc.			

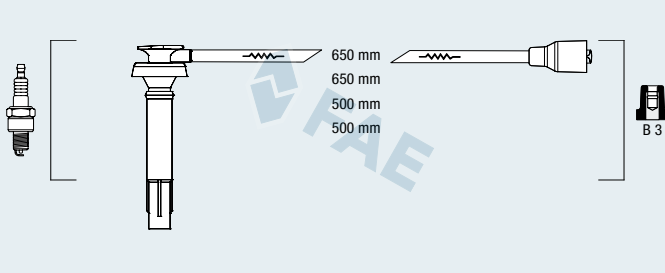
Ref. 83235 NEW

SUBARU			
Impreza 1.6 4WD Coupe	1996-00		
Impreza 1.6 AWD Sedan	2000 ->		
Impreza 1.6 Coupe	1996-00		
Impreza 1.6 i 4WD S.W.	1992-00		
Impreza 1.6 i 4WD Sedan	1992-00		
Impreza 1.6 i S.W.	1998-00		
Impreza 1.6 i Sedan	1992-00		
Impreza 1.6 S.W.	2000 ->		

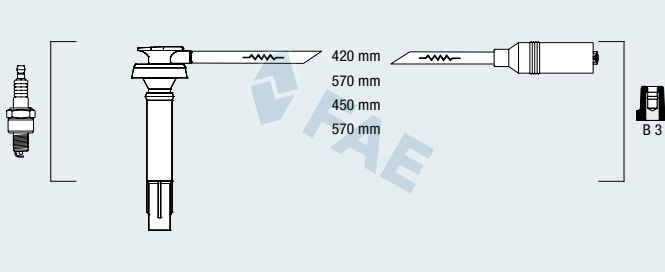
Ref. 83236 NEW

SUBARU			
Forester 2.0	2002 ->		
Impreza 2.0 S.W.	2000 ->		
Impreza 2.0 Sedan	2000 ->		
Legacy III 2.0, S.W.	1998-03		
Legacy III 2.5, S.W.	1998-03		
Outback 2.5	2000-03		

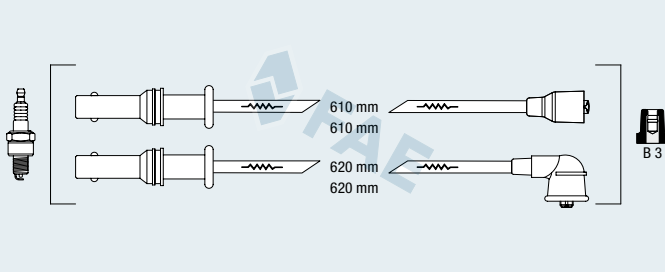
Ref. 83237 NEW

SUBARU			
Forester 2.0	1997-02		

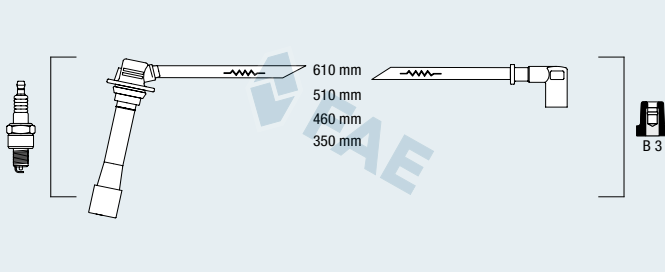
Ref. 83261

MAZDA			
323 1.8 i 16V	1994-98		
323 Coupe 1.8 i 16V	1994-98		
323 F 1.8 i 16V	1994-98		
MX-3 1.6 i	1994 ->		
Xedos 6 1.6 i 16V	1992 ->		



Ref. 83262 NEW

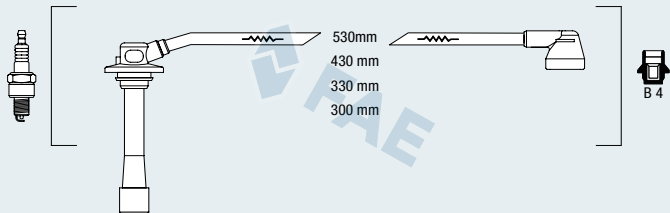

MAZDA			
626 V 1.8	1997-99		
626 V 1.8 Hatchback	1997-99		
626 V 1.8 Station Wagon	1998-00		
626 V 2.0	1997-02		
626 V 2.0 H.P. Hatchback	1998-02		
626 V 2.0 Hatchback	1997-02		
626 V 2.0 Station Wagon	1998-02		

Ref. 83263 NEW

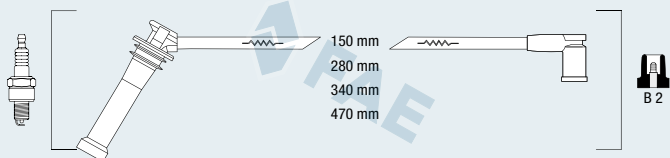

MAZDA			
6 1.8	2002 ->		
6 1.8 Hatchback	2002 ->		
6 1.8 Station Wagon	2002 ->		
6 2.0	2002 ->		
6 2.0 Hatchback	2002 ->		
6 2.0 Station Wagon	2002 ->		

Ref. 83264 NEW

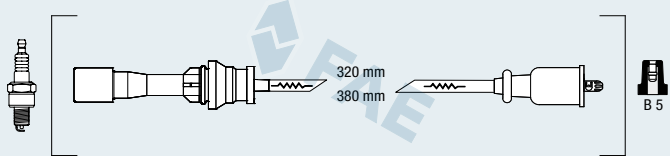

MAZDA			
323 FVI 1.5 16V	1998-01		
323 FVI 1.6	2001-04		
323 S VI 1.5 16V	1998-01		
323 S VI 1.6	2001-04		

Ref. 83265 NEW

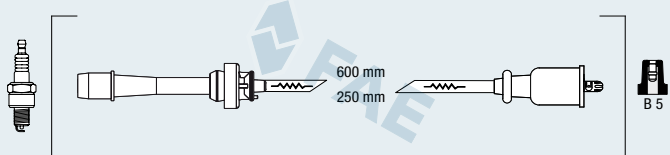

MAZDA			
323 FVI 2.0	2001-04		
323 S VI 2.0	2001-04		
MPV II 2.0	1999-00		
Premacy 1.8	1999 ->		
Premacy 1.9	1999 ->		

Ref. 83266 NEW

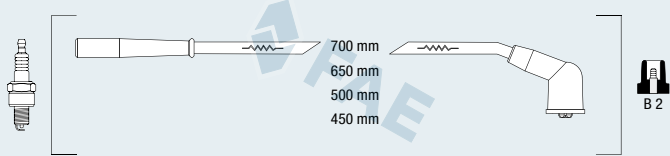

MAZDA			
323 FVI 1.4	2001-04		
323 FVI 1.4 16V	1998-01		
323 PV 1.3 16V	1996 ->		
323 S VI 1.4	2001-04		
323 S VI 1.4 16V	1998-01		

Ref. 83270

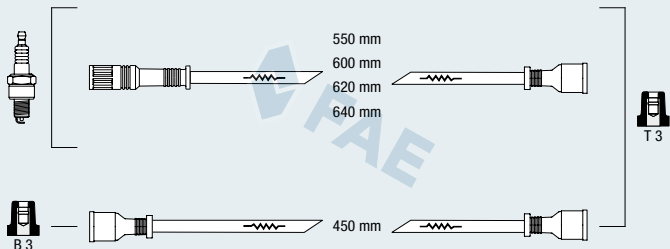

SUZUKI-SANTANA			
Vitara 1.6, Cabrio	1988-98		



Ref. 83380

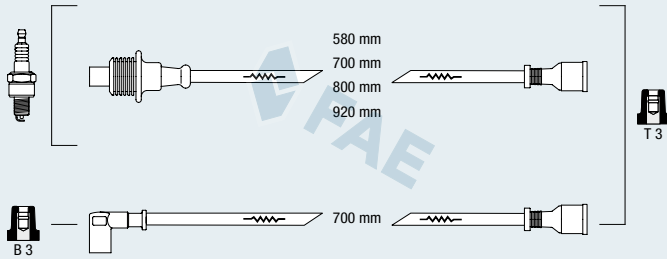

CITROËN		PEUGEOT	
BX 16	1982-92	205 1.6 GTI, CTI (XU)	1985-89
BX 16 E, Break	1989-93	205 Automatics	1985-89
BX 16, Break	1982-88	305 1.6, 1.9, 1.9 i	1987-88
BX 19 Break, 4x4	1990-91	309 1.6, 1.9, GT, (XU)	1986-89
BX 19 E 4x4	1989-93	309 1.6 GRI, SRI, GTI	1987-90
BX 19 E, Break, 4x4	1988-93	309 1.6 i (XU5J)	1987-90
BX 19 GTi	1986-93	309 Automatics	1986-90
BX 19 GTi 16V	1987-88	405 1.9 GLI, GRI, SRI	1987-90
BX 19 GTi, Break, 4x4	1988-93	405 1.9 i (XU9J1)	1987-90
BX 19 Kat Break	1986-94		

Ref. 83390

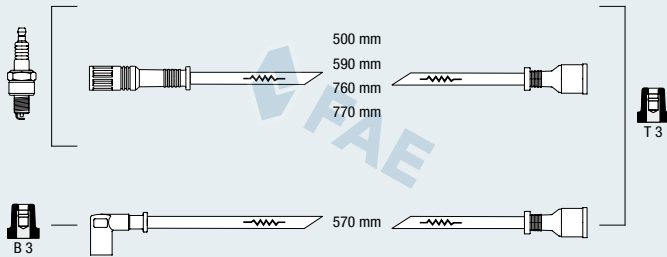

FIAT		FORD	
Croma 1600	1985-90	Capri 1.3 (OHV)	1978-87
Croma 2000 CHT	1985-89	Cortina 1.3 (OHV)	1976-82
Croma 2000 i.e.	1986-90	Escort 1.1, 1.3, 1.6	1974-80
Croma 2000 i.e. Turbo	1985-90	Escort 1.1, 1.3. (OHV)	1980-86
		Escort RS 1600	1974-80
		Fiesta 1.0, 1.1. (OHV)	1976-88
		LANCIA	
		Delta I 1.6 GT i.e.	1986-88
		Thema 2000 i.e. Turbo, SW	1986-90

Ref. 83400

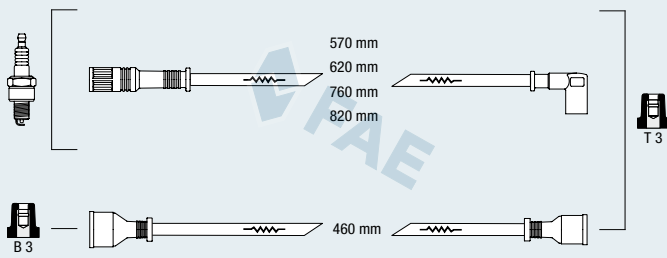

FORD		FORD Cont.	
Capri 1300	1968-72	Orion 1.3, 1.4, 1.6, 1.6 i	1983-88
Capri 1500	1968-74	P 100 II 2.0	1987 ->
Escort 1.1, 1.3. (CVH)	1980-86	Scorpio I 1.8	1985-92
Escort 1.4, 1.6. (CVH)	1986-88	Scorpio I 2.0	1985-89
Escort 1.6 XR3 (CVH)	1980-86	Sierra 1.8 Kombi	1984-86
Escort 1.6 i XR3 (CVH)	1986-88	Sierra 2.0	1982-86
Escort RS 1600	1982-83	Sierra 2.0 Kombi	1982-86
Fiesta 1.3, XR2. (OHV)	1976-83	Transit 1.6	1977-86
Fiesta 1.3, 1.4. (CVH)	1983-88	Transit 2.0	1977-82
Fiesta 1.6 XR2 (CVH)	1983-88	Transit 2.0 i	1991-94

Ref. 83450

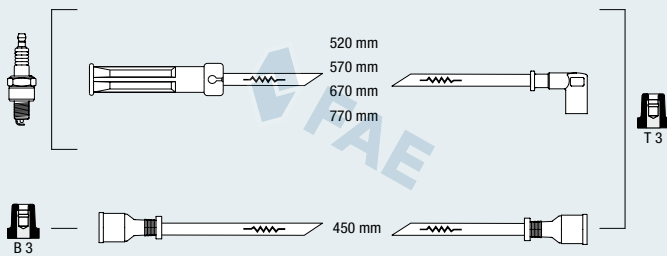

FORD		LADA	
Escort 1.1, 1.3. (HCS)	1988-90	Samara 1100	1988-94
Escort 1.4, 1.6. (CVH)	1988-90	Samara 1500, Forma	1991 ->
Fiesta 1.4, 1.6. (CVH)	1989-91	ROVER	
Granada 1.6	1981-85	213 S	1985-89
Orion 1.4, 1.6. (CVH)	1988-90	TRIUMPH	
Probe 2.2 i Turbo	1988 ->	Acclaim 1.3	1982-85
Sierra 1.6 i, Kombi	1989-93		

Ref. 83460

Supplied up to exhausting stock / Suministrado hasta agotar existencias / Fourni jusqu'a épuisement du stock

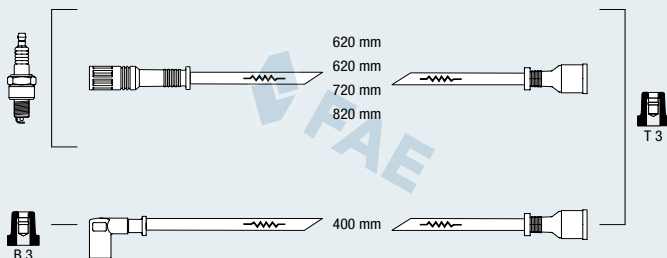

FORD		FORD Cont.	
Capri 1600, 2000	1972-87	Taurus 1300, 1600, 2000	1970-83
Cortina 1600, 2000	1976-82	Transit 1.6, 2.0	1978-88
Escort RS 2000	1976-80		
Granada 2000	1972-81	Engines/Motores/Moteurs:	
Granada 2.0 EFI	1987-89	OHC.	
P100 Pick-up 1.6	1982-88	HYUNDAI	
P100 Pick-up 2.0	1988 ->	Pony 1200, 1400, Pick-up	1981-85
Scorpio 1.8, 2.0, 2.0 i	1985-92		
Scorpio 2.0 EFI	1987-89		
Sierra 1.6, 1.8, 2.0, 2.0 i	1985-93		

Ref. 83480

Supplied up to exhausting stock / Suministrado hasta agotar existencias / Fourni jusqu'a épuisement du stock

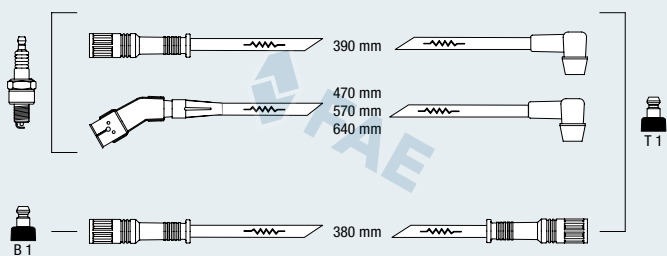

OPEL		VAUXHALL	
Ascona C 1.8 E CC	1985-86	Belmont 1.3	1987-91
Ascona C 1.8 i	1982-86	Nova 1.2, 1.3	1987-93
Ascona C 1.8 i CC	1982-86		
Corsa A 1.2 i, CC, TR	1989-93		
Corsa A 1.3 i CC	1986-90		
Corsa A 1.3, Furgón, CC	1985-89		
Kadett D 1.8 GT/E	1983-84		
Kadett E 1.3 N	1984-89		
Kadett E 1.3 N, Caravan, Combo	1984-91	Engines/Motores/Moteurs:	
Kadett E 1.3 N, CC, Van	1984-89	OHC.	

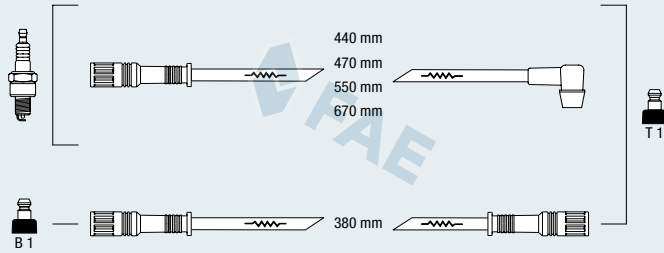
**Ref. 83490**

OPEL		VAUXHALL	
Ascona C 1.3 N CC	1981-86	Astra MKI 1.3	1984-88
Ascona C 1.3 S CC	1981-88	Belmont 1.3	1983-87
Corisa A 1.2, Furgón, CC	1982-90	Nova 1.2, 1.3	1983-87
Kadett D 1.2 S	1979-84		
Kadett D 1.2 S Caravan	1979-84		
Kadett D 1.3 N	1979-84		
Kadett D 1.3 N Caravan	1979-84		
Kadett E 1.3 i Kat	1985-91		
Kadett E 1.3 i Kat, Caravan, CC	1985-91	Engines/Motores/Moteurs:	
Kadett E 1.3 S, Cabrio, Combo	1986-89	OHC.	

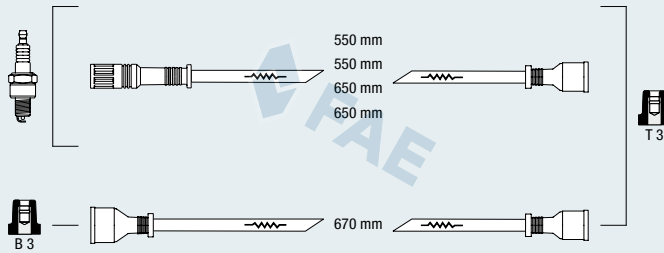
Ref. 83500

OPEL		VAUXHALL	
Corisa A 1.0, CC, TR, Furgón	1982-93	Belmont 1.2	1985-89
Corisa A 1.2 Furgón	1986-89	Cavalier (FWD) 1.0, 1.2	1980-84
Corisa A 1.2 N CC	1990-93	Nova 1.0, 1.2	1983-92
Corisa A 1.2 N TR	1985-87	VOLKSWAGEN	
Corisa A 1.2, Furgón, CC	1982-90	Golf GTI	1974-84
Kadett D 1.2	1979-82	Jetta GTX	1976-84
Kadett D 1.2 Caravan	1979-82		
Engines/Motores/Moteurs:			
OHV.			

Ref. 83510

Supplied up to exhausting stock / Suministrado hasta agotar existencias / Fourni jusqu'a épuisement du stock

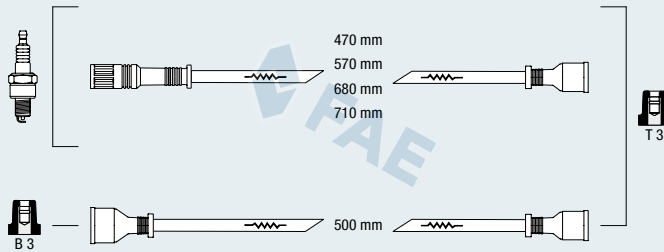

OPEL		VAUXHALL	
Ascona C 1.3	1980-83	Astra MKI 1.3	1980-83
Kadett D 1.6 SR, 1.8 GTE	1982-84	Cavalier (FWD) 1.3	1980-83
Kadett E 1.3	1980-83	Cavalier (FWD) 1.6 S, SV	1984-87
Kadett E 1.6 S, SV	1984-87	Cavalier (FWD) 1.6 SR	1982-84
Kadett E 1.8 GSI	1984-86	Cavalier (FWD) 1.8 GTE	1982-84
		Cavalier (FWD) 1.8 GSI	1984-86
Engines/Motores/Moteurs:			
OHV.			

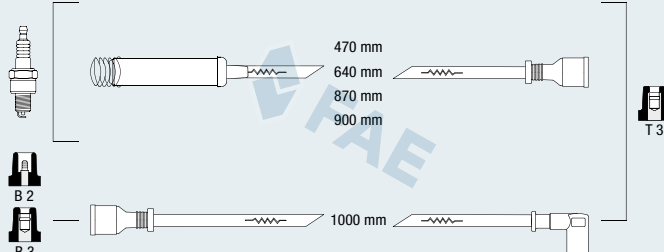
Ref. 83530

OPEL		VAUXHALL	
Omega 1.8 ->N°14258179	1986-90	Carlton 1.8, 1.8 i, 2.0 i	1986-92
Omega 1.8 i ->N°14258179	1987-90		
Omega 2.0 i ->N°14180385	1987-92		
Omega GL, GLS, LS, CD	1986-90		
Vectra A 1.8 i Kat, CC	1990-95		
Vectra A 2.0, CC	1988-89		
Engines/Motores/Moteurs:			

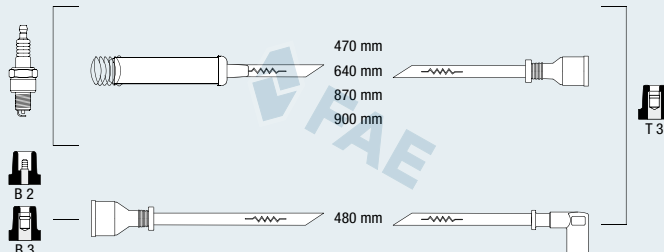
Ref. 83550

OPEL		VAUXHALL	
Ascona A 1.2 S	1972-75	Astra MKI, II 1.8 i, 2.0 i	1982-88
Ascona A 1.6 N	1970-75	Belmont 1.8 i, 2.0 i	1987-89
Ascona B 1.6 S	1975-81	Nova 1.6 i	1986-89
Ascona C 1.6 i Kat	1986-88		
Ascona C 1.8 E CC	1985-86		
Ascona C 2.0 i Kat CC	1986-88		
Corisa A 1.6 GSI CC	1988-92		
Kadett E 1.8	1987-90		
Kadett E 1.8 i	1985-86	Engines/Motores/Moteurs:	
Kadett E 1.8 i CC	1985-91	NE, SE.	

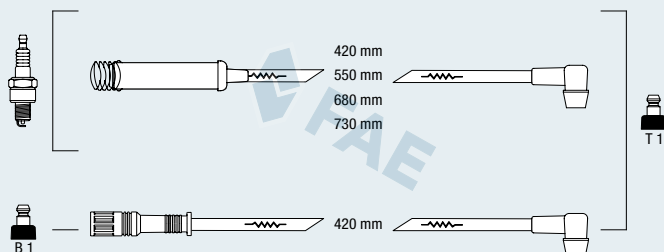
Ref. 83560

DAEWOO		VAUXHALL	
Nexia 1.5 GL (G15MF)	1995-97	Astra 1.6 i	1991-93
OPEL		Belmont 1.6	1987-89
Ascona C 1.6 i Kat	1986-88	Cavalier 1.6 i	1991-93
Ascona C 1.6 i Kat CC	1986-88	Nova 1.6 i Cat.	1987-92
Astra 1.6 i 75 cv.	1991-93		
Corisa 1.6 i Cat.	1987-92		
Kadett E 1.6 LS, GL, GLS	1987-89		
Kadett E 1.6 Top, S, SV	1987-89		
Vectra 1.6 i	1991-93	Engines/Motores/Moteurs:	
		16NZ, C16NZ.	



Ref. 83561

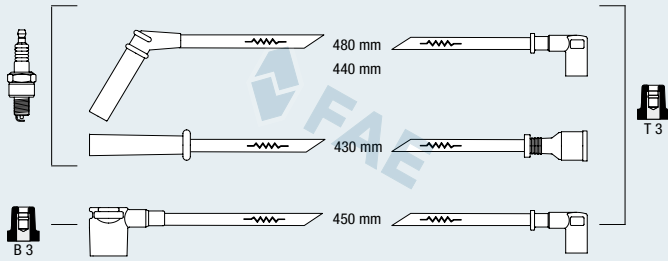

CHEVROLET		DAEWOO	
Matiz 0.8, LPG	2005 ->	Matiz 0.8, Furgón	1998 ->
Spark 0.8	2005 ->	Tico 0.8	1995-00

Ref. 83562

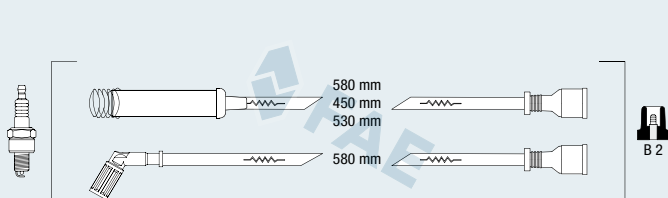

CHEVROLET		DAEWOO	
Aveo 1.4 Sedan	2006 ->	Kalos 1.4	2002 ->
Kalos 1.4, Sedan	2005 ->	Kalos 1.4 16V, Sedan	2003-04
Lacetti 1.4 16V	2005 ->	Kalos 1.4, Sedan	2002-04
		Lanos 1.4	1997 ->
		Lanos 1.5	1997 ->
		Lanos 1.5 Sedan	1997 ->
		Tacuma 1.8	2000 ->

Ref. 83563

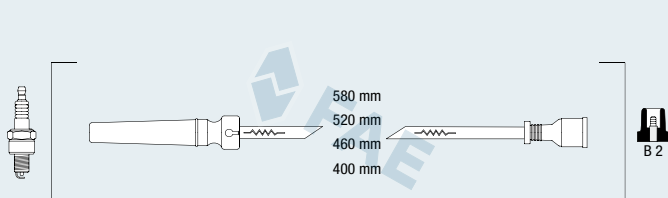

CHEVROLET		DAEWOO	
Aveo 1.4 Sedan	2006 ->	Kalos 1.4 16V, Sedan	2003 ->
Aveo 1.4, Sedan	2008 ->	Lacetti 1.4 Fastback	2004 ->
Kalos 1.4 16V, Sedan	2005 ->	Lanos 1.6 16V, Sedan	1997 ->
Tacuma 1.6	2005 ->	Nubira 1.6 16V, Sedan, Wagon	1997 ->
		Tacuma 1.6	2000 ->

Ref. 83564

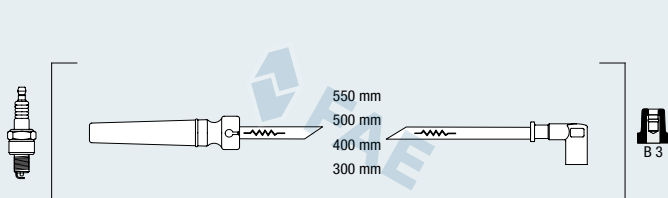

CHEVROLET		DAEWOO	
Lacetti 1.4 16V	2005 ->	Nubira 1.6 Kombi, Sedan	2005 ->
Lacetti 1.6	2005 ->	Lacetti 1.6 Fastback	2004 ->
		Nubira 1.6 Sedan, Wagon	2003 ->

Ref. 83565 NEW

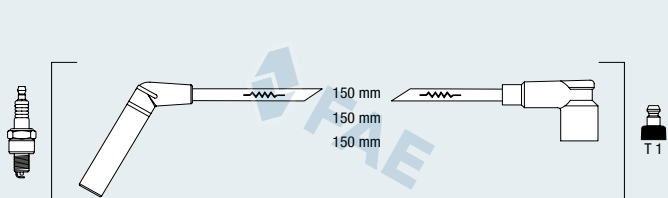

CHEVROLET		DAEWOO	
Matiz 0.8, LPG	2005 ->		

Ref. 83566 NEW

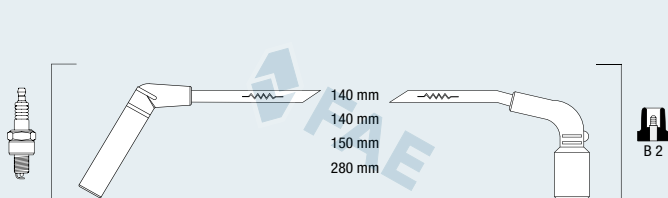

CHEVROLET		DAEWOO	
Aveo 1.2 Sedan	2006 ->	Kalos 1.2	2003 ->
Aveo 1.2, Sedan	2008 ->	Matiz 1.0	2003 ->
Kalos 1.2	2005 ->		
Kalos 1.2 Sedan	2005 ->		
Matiz 1.0	2005 ->		
Matiz 1.0, LPG	2005 ->		
Spark 1.0 SX	2005 ->		

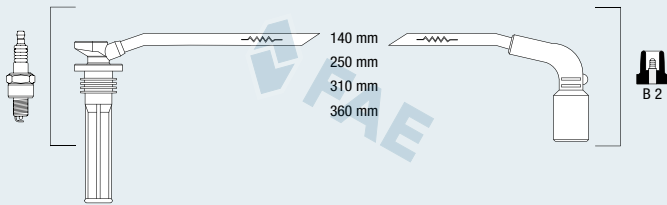
**Ref. 83567 NEW**

CHEVROLET			
Aveo 1.2 (T300)	2011 ->		
Aveo 1.2 Sedan (T300)	2011 ->		
Spark 1.0	2010 ->		
Spark 1.2	2010 ->		

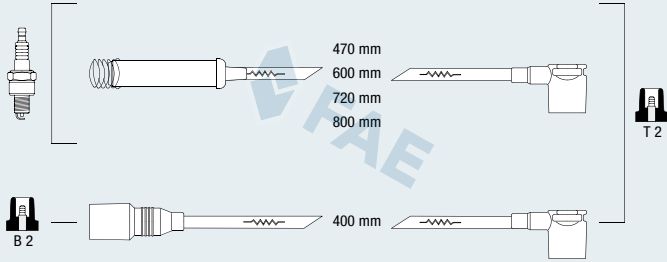
Ref. 83570

OPEL		OPEL Cont.	
Ascona C 1.6	1985-88	Corsa 1.6 i 02E88110->	1989-92
Astra 1.2 i (C12NZ)	1991-93	Kadett E 1.4 (14NV)	1989-91
Astra 1.4 i (C14NZ)	1991-93	Kadett E 1.4 i (C14NZ)	1989-91
Combo 1.4 i (X14SZ)	1995 ->	Kadett E 1.6 GT, Tiffany	1989-91
Corsa 1.2 i Swing, City	1993 ->	Kadett E 1.6 S, SV. (16SV)	1989-91
Corsa 1.2 i (12NZ, C12NZ)	1993 ->	Vectra A 1.4 S, CC	1988-92
Corsa 1.4 GL, GT, S. (14NV)	1990-92	Vectra A 1.6 i Kat, CC	1988-95
Corsa 1.4 i Cat. (C14SE)	1987-92	Vectra A 1.6, CC	1988-93
Corsa 1.4 i Swing, Joy	1993 ->	VAUXHALL	
Corsa 1.4 i (C14NZ)	1993 ->		

Ref. 83580

Supplied up to exhausting stock / Suministrado hasta agotar existencias / Fourni jusqu'a épuisement du stock

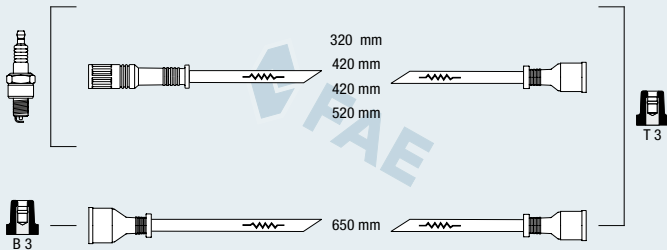

TOYOTA			
Carina E 1.6 Sedan	1983-87		
Carina II 1.6	1983-87		
Carina II 1.6 Station Wagon	1987-92		
Carina II 1.6, Sedan, S.W.	1987-89		
Carina II 1.6, Station Wagon	1987-92		
Celica 2.0	1975-77		
Corolla 1.3	1979-83		
Corolla 1.3 FX Compact	1985-87		
Corolla 1.3 Liftback	1979-82		
Corolla 1.6	1983-87		
Corolla 1.6 FX Compact	1984-87		
Corolla 1.6 Liftback	1983-87		
Cressida 2.0 S.W.	1977-81		
Cressida 2.0 Sedan	1977-81		
Hi-Ace. Hi-Lux. Lite-Ace	1963-79		
Liteace 1.3	1979-86		
Liteace 1.3 Wagon	1979-85		
Liteace 1.5	1985-89		
Liteace 1.8 D Wagon	1982-85		
Tercel (FWD) 1.3, 1.5	1976-84		
VOLVO			
66. Series 100. Series 140	1963-79		
345 GL	1976-84		

DACIA

Duster. Pick-up. 1397 cc.	1984 ->
Shifter	1984 ->

DAIHATSU

Charmant 1.3	1981-87
Charmant 1.6	1981-84

FIAT

127 1.0	1977-86
127 1.0 Panorama	1977-86
127 1.3 Sport	1981-83
147 1.3	1980-83
147 1.3 Rallye	1980-83
147 1.4	1980-96

FIAT Cont.

Fiorino 1.3 Pick up	1988-94
Fiorino 60 1.1 Furgón	1988-93
Fiorino 70 1.3	1988-94

NISSAN-DATSUN

Cherry I 1.0	1970-78
Cherry II 1.0 Hatchback	1978-81
Cherry II 1.2 Hatchback	1978-81
Sunny 1171 cc.	1973-82

ROVER

Ambassador/Ital/Marina	1978-84
Rover 2000. 2300. 2600	1982-86

Ref. 83581

Supplied up to exhausting stock / Suministrado hasta agotar existencias / Fourni jusqu'a épuisement du stock

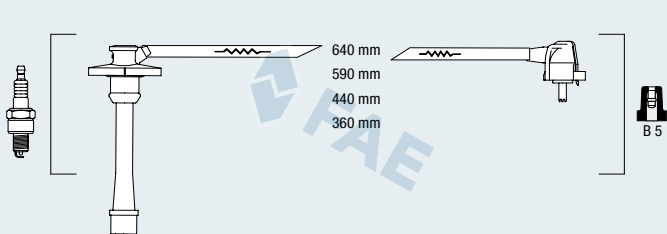

TOYOTA		TOYOTA Cont.	
Avensis 1.6, Liftback, S.W.	1997-00	Corolla 1.6 GLI Liftback	1992-97
Carina E 1.6 16V, Sedan	1994-97	Corolla 1.6 Si, Compact, Wagon	1992-97
Carina E 1.6 GLI, Sportswagon	1992-97	Corolla 1.6, Compact, Liftback	2000-02
Carina E 1.6 i Sportswagon	1995-97	Corolla 1.6, Compact, Liftback, Wagon	1997-00
Carina E 1.6 Sportswagon	1992-97	Corolla 1.8 GT, Compact, Liftback	1992-95
Carina E 1.6, Sedan	1993-97		
Celica 1.8 i 16V	1993-99		
Corolla 1.6 16V, Wagon	2000-02		
Corolla 1.6 Aut., Compact, Liftback	1997-00		
Corolla 1.6 Aut., Wagon	1997-00		

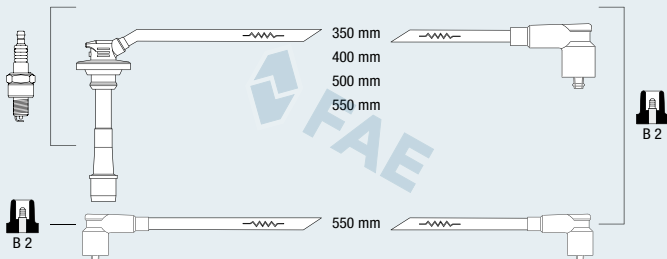
Ref. 83585 NEW

TOYOTA			
Avensis 1.6, Liftback, S.W.	1997-00		
Carina E 1.6 16V, Sedan	1994-97		
Carina E 1.6 GLI, Sportswagon	1992-97		
Carina E 1.6 i Sportswagon	1995-97		
Carina E 1.6, Sedan	1993-97		
Carina E 1.8	1995-97		
Carina E 1.8 i 16V Sedan	1995-97		
Carina E 1.8 i Sportswagon	1995-97		



Ref. 83586 NEW

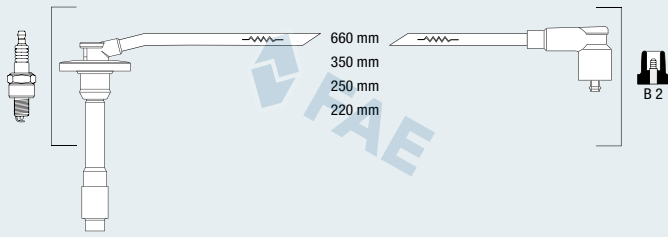

TOYOTA			
Avensis 1.8, Liftback, S.W.	1997-00		

Ref. 83587 NEW

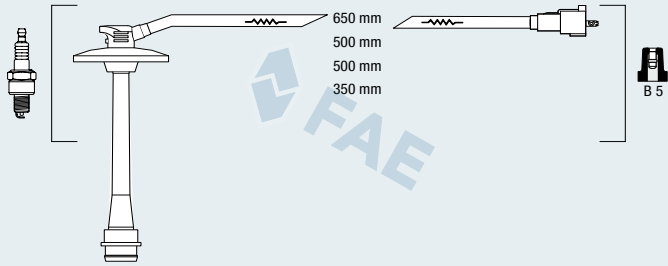

TOYOTA			
Avensis 2.0, Liftback, S.W.	1997-00		
Camry 2.2	1996-01		
Picnic 2.0	2001-01		
Picnic 2.0 16V	1996-01		
Rav 4 I 2.0 16V, Cabrio	1994-00		

Ref. 83588 NEW

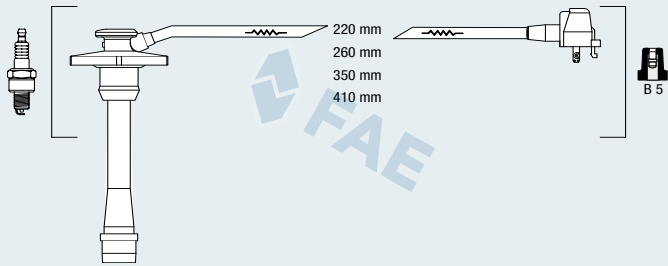

TOYOTA			
Corolla 1.4, Compact, Liftback, Wagon	1997-00		

Ref. 83590

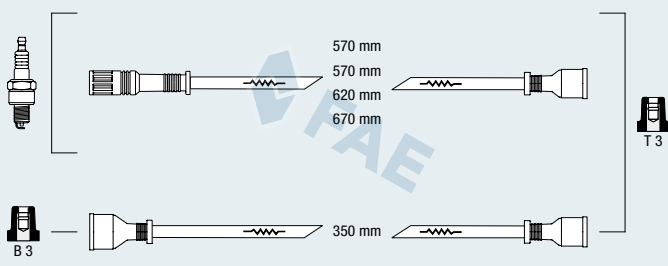

SUZUKI-SANTANA			
Samurai 1.0 Allrad	1988 ->		
Samurai 1.3	1988 ->		
Samurai 1.3 Allrad	1988 ->		
SJ 410 1.0, Cabrio	1981-88		
SJ 413 1.3	1984-88		
Swift I 1.3	1984-89		

Ref. 83640

Supplied up to exhausting stock / Suministrado hasta agotar existencias / Fourni jusqu'a épuisement du stock

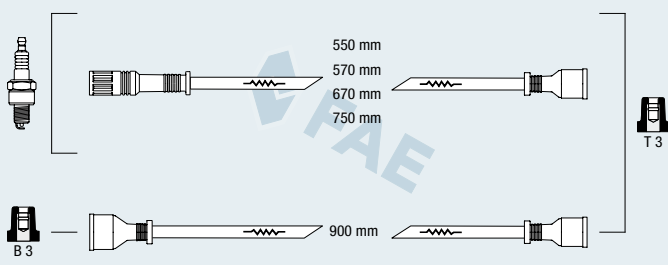

CITROËN		MAZDA Cont.	
CX	1975-89	Legato, Luce	1979 ->
FIAT		NISSAN-DATSUN	
131 Super	1981-83	Cherry	1971-77
132 1.6, 2.0	1980-82	Cherry (N10) 1.0, 1.2, 1.3	1979-82
Argenta 1600, 2000	1981-85	ROVER GROUP	
Argenta A.A.	1981-85	213 1342 cc.	1984-89
Panda 1.0 i Selecta	1991 ->	TOYOTA	
Ritmo 105, 125, 130. TC	1981-87	Celica 2.0 (21R)	1982-86
MAZDA		Cressida 2.0 (21R)	1981-82
616 1600, 1800, 2000	1971-83	Starlet 1.0, 1.3. (12V)	1985 ->
626 1600, 1800, 2000	1971-83		
929 1800, 2000	1974-80		

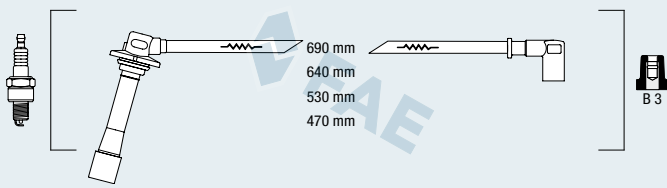
**Ref. 83641**

MAZDA			
626 IV 1.8 i	1992-97		
626 IV 1.8 i Hatchback	1991-97		
626 IV 2.0 i	1992-97		
626 IV 2.0 i 4WD	1992-97		
626 IV 2.0 i 4WD Hatchback	1992-97		
626 IV 2.0 i Hatchback	1991-97		
626 IV 2.5 24V Hatchback	1992-97		
929 2.2, 2.2 i. (EU)	1986-91		
MX-6 2.0 i (EU)	1991 ->		
MX-6 2.0 i 16V	1994-97		

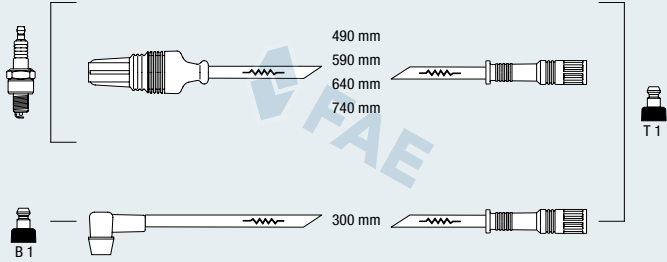
Ref. 83650

CITROËN		PEUGEOT	
AX 10. AX 11	1987-92	106 954-1124-1360 cc.	1991-93
AX 14. AX GT	1987-92	106 1.1 i (TU1M)	1991-92
AX 1.0 i (TU9M)	1995-96	106 1.3 i (KDY)	1991-92
BX 1.8 D, Break	1985-93	205 954-1124-1294-1360	1987-93
BX TRD Turbo, Break	1988-93	205 1.2 i, 1.4 i	1988-94
C 15 E	1988-96	306 1.4 (TU3)	1992-93
ZX 1.1, 1.4. Carb.	1991-93	309 GE, GR, XE, XA, Profil	1987-93
ZX 1.4 i -> PR-5904	1992-93	309 1.1 i, 1.3 i	1989-93
ZX 1.8 i 16V, Break	1996-98	405 1.4 GL, GR	1987-93
ZX 1.8 i, Break	1993-97	Ranch 1.4	1996 ->

Ref. 83660

Supplied up to exhausting stock / Suministrado hasta agotar existencias / Fourni jusqu'a épuisement du stock

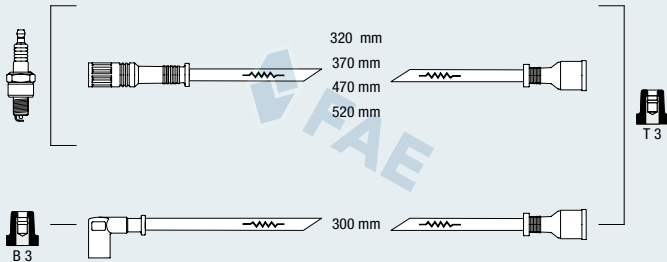

AUDI		SEAT	
50 1.3	1977-78	127 Fura, Crono	1981-85
80 1.5	1972-75		
80 1.6	1975-78	VOLKSWAGEN	
80 1.6 GLE	1979-86	Caddy 1.5, 1.6, 1.8.	1982-84
80 1.6 GT	1973-76	Golf 1.5, 1.6, 1.8	1976-84
80 1.6 GTE	1976-78	Jetta 1.5, 1.6, 1.8	1976-84
80 1.8	1983-86	Passat 1.3, 1.6, 1.8	1980-84
100 4 cil.	1969-84	Sanatana 1.6, 1.8	1980-84
Coupe 1.6	1980-81	Scirocco 1.5, 1.6, 1.8	1974-84
Coupe 1.8, GT	1981-88		

Ref. 83720

Supplied up to exhausting stock / Suministrado hasta agotar existencias / Fourni jusqu'a épuisement du stock

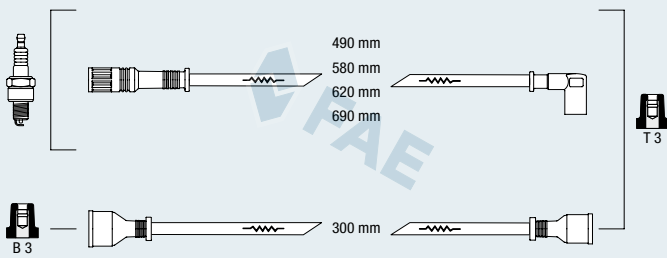

VOLKSWAGEN		VOLKSWAGEN Cont.	
Derby 0.9	1977-81	Polo 0.9	1975-81
Derby 1.0	1981-84	Polo 1.1	1975-81
Derby 1.1	1977-81	Polo 1.1, Coupe	1975-81
Derby 1.3	1977-81		
Golf I 1.1	1974-83		
Golf I 1.3	1979-83		
Jetta I 1.1	1978-84		
Jetta I 1.3	1979-84		
Passat 1.3, Variant	1980-83		
Polo 0.8	1975-81		

Ref. 83740

Supplied up to exhausting stock / Suministrado hasta agotar existencias / Fourni jusqu'a épuisement du stock

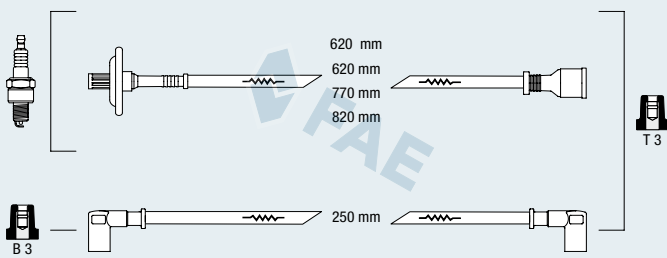

VOLKSWAGEN		VOLKSWAGEN Cont.	
1500, 1600 1.5 S	1963-65	Escarabajo 1303 1.3 (13)	1972-75
1500, 1600 1.5 S Variant	1963-65	Escarabajo 1303 1.3 Cabrio	1970-81
1500, 1600 1.5, L, Variant	1961-73	Escarabajo 1303 1.6 (13)	1972-79
Escarabajo 1.1 (Brezel)	1949-53	Escarabajo 1303 1.6 Cabrio	1970-74
Escarabajo 1.2 (42005)	1954-65	Escarabajo 1303 LS, S 1.6 (13)	1972-79
Escarabajo 1200 1.2 (11)	1960-85	Escarabajo 1500 1.5 (11)	1966-73
Escarabajo 1300 1.3	1965-70	Escarabajo 1500 1.5 Cabrio	1966-70
Escarabajo 1302, 1303 1.6 Cabrio	1970-79	Escarabajo 1500 1.6	1970-73
Escarabajo 1303 1.2 (13)	1972-76	Escarabajo 1500 1.6 Cabrio	1969-70
Escarabajo 1303 1.2 Cabrio	1975-79	Escarabajo Karmann 1.3 Cabrio	1964-70

Ref. 83750

Supplied up to exhausting stock / Suministrado hasta agotar existencias / Fourni jusqu'a épuisement du stock

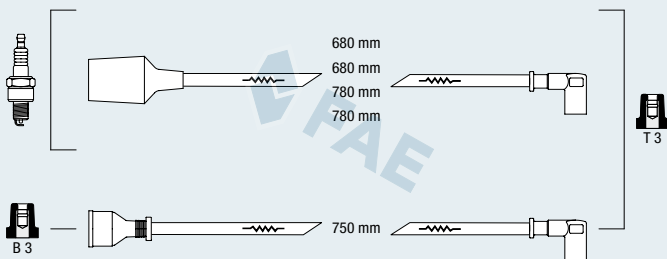

ALFA ROMEO		ALFA ROMEO Cont.	
33 1.2	1983-89	Alfasud 1.3 SC/ti Super	1977-84
33 1.3	1983-89	Alfasud 1.3 ti	1977-84
33 1.3 i.e.	1983-89	Alfasud 1.3, Giardinetta	1978-79
33 1.4 i.e., Sport Wagon, 4x4	1991-94	Alfasud 1.3, Giardinetta, Super	1979-84
33 1.5 4x4	1986-89	Alfasud Sprint 1.5	1978-81
33 1.5 i.e.	1990-91	Alfasud Sprint 1.5, ti	1983-84
145 1.4 ie 90 cv.	1994 ->	Alfasud Sprint 1.7	1987-89
Alfasud 1.2	1980-84	Alfasud Sprint 1.7 i.e.	1987-89
Alfasud 1.2 ti	1973-84	Alfasud Sprinter 1.5 Veloce	1983-87
Alfasud 1.2, Giardinetta	1972-84	Arna 1.2, 1.3, 1.5, TI	1983-87



Ref. 83790

Supplied up to exhausting stock / Suministrado hasta agotar existencias / Fourni jusqu'a épuisement du stock

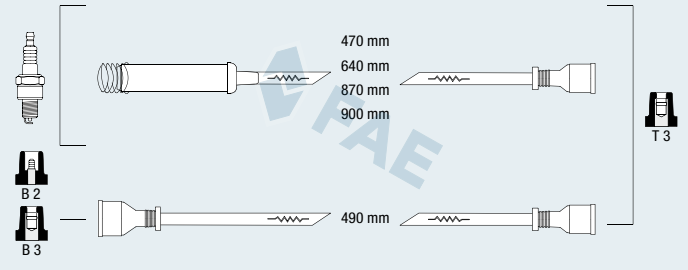

OPEL		VAUXHALL	
Corsa 1.6 i (E16SE)	1989-92	Belmont 1.8 i, 2.0 i	1989-90
Kadett E 1.8 i, 2.0 NE,SE	1989-90	Carlton 2.4 i (C24NE)	1987-90
Kadett E 2.0 GSI	1989-90	Cavalier 2.0 i	1988-90
Omega 2.4 i Cat.->036313	1987-90	Nova 1.6 i	1989-92
Vectra A 1.8 S, CC, 4x4	1988-89		
Vectra A 2.0 i Kat, 4x4, CC	1988-95		
Vectra A 2.0 i, 4x4, CC	1988-90		
Vectra A 2000 16V 4x4	1989-90		
Vectra A 2000/GT 16V	1989-94		
Vectra A 2000/GT 16V 4x4 Kat	1990-95		

Ref. 83800

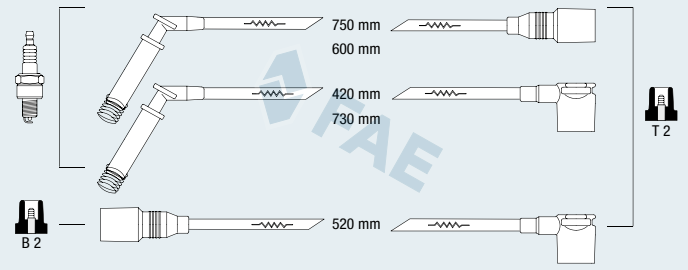

OPEL		OPEL Cont.	
Astra 1.8 i ->14349311	1991-93	Vectra 2.0 i (C20NE)	1990-95
Astra 2.0 i ->14672353	1991-94	Vectra 2.0 i GT (20SEH)	1990-95
Calibra 2.0 i ->14672353	1990-93	VAUXHALL	
Corsa 1.6 GSI (16SE)	1990-93	Astra 1.8 i, 2.0 i	1991-93
Frontera 2.4 i (C24NE)	1992-93	Belmont 1.8 i, 2.0 i	1990-91
Kadett E 1.8 i, 2.0 i (NE,SE)	1990-91	Calibra 2.0 i	1990-93
Kadett E 2.0 GSI	1990-91	Carlton 2.4 i	1990-94
Omega 2.4 i Cat. (C24NE)	1990-94	Cavalier 1.8, 1.8 i, 2.0 i	1989 ->
Vectra 1.8 (E18NVR, E18SV)	1991-95	Frontera 2.4 i	1992-93
Vectra 1.8 i Cat. (C18NZ)	1988-89	Nova 1.6 GSI	1990-93

Ref. 83810

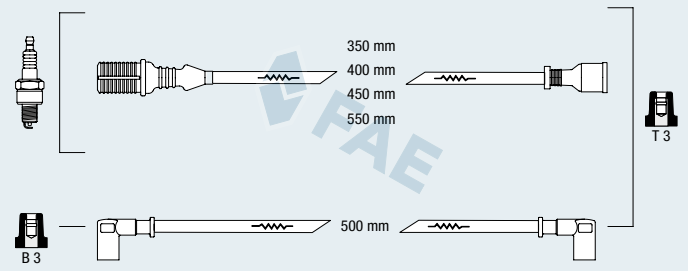

PEUGEOT			
505 2.0	1980-82		
505 2.0 Break	1982-87		
505 2.0 TI,STI	1979-86		
505 2.2	1981-84		
505 2.2 Break	1986-93		
505 2.2 GTI	1983-93		
505 2.2 GTI Break	1985-86		

Ref. 83820

Supplied up to exhausting stock / Suministrado hasta agotar existencias / Fourni jusqu'a épuisement du stock

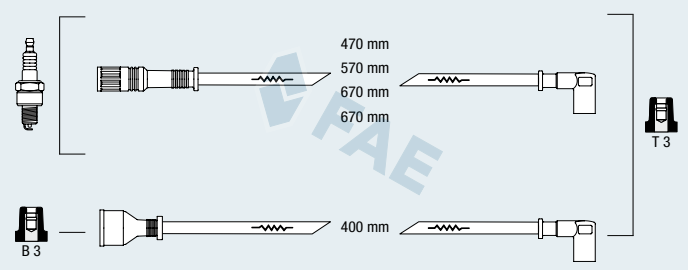

BMW		HONDA	
315	1980-83	Accord 2.0 EX, 2.0 i EX	1986-89
316, 318, 320, 4 cil.	1975-87	PEUGEOT	
518, 520, 520 L, 4 cil.	1974-86	309 II 1.6	1989-93
CITROËN		405 I 1.9, Break	1987-92
BX 15, Break	1987-92	ROVER GROUP	
BX 16 E, Break	1989-93	Metro 1.1, 1.4	1990-93
BX 16, Break	1985-93	111 C, L, S, SL	1989 ->
BX 19 E 4x4	1989-93	114 S, SL, GS	1990 ->
BX 19 Gti, Break, 4x4	1988-93	214 S 1.4 i 75 cv (8V)	1990-92
		414 1.4 i SI, SLI. (8V)	1990-92

Ref. 83850

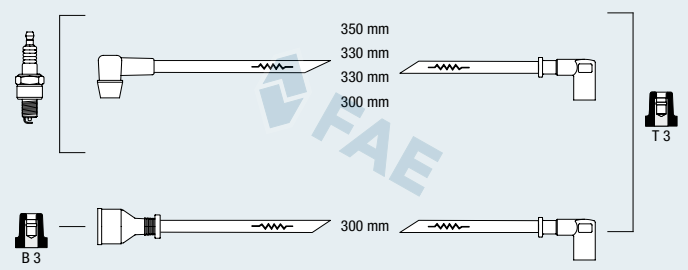

ROVER GROUP		ROVER GROUP Cont.	
1100, 1300, MKI, II	1963-73	Mini 1.3 i, Cooper	1991 ->
1800 MKI, II, III	1964-76	Minor 1000, 1100	1956-71
Allegro 1.1, 1.3, 1.5, 1.7	1973-83	Montego 1.3	1984-88
Maestro 1.3	1983-84	Princess 1300	1967-74
Marina 1.3, 1.8, MKI, II	1971-80	Princess 1800, HL	1975-78
Maxi 1.5, 1.7, MKI, II	1969-81	RELIANT	
Metro 1.0, 1.1, 1.3	1980-89	Rebel 700	1968-71
Mini 850-1000 MKI, II	1959-84	Rebel 750	1971-73
Mini Clubman, Estate	1968-80	TRIUMPH	
Mini Moke	1965-69	1300 1.3 TC	1966-70

Ref. 83860

Supplied up to exhausting stock / Suministrado hasta agotar existencias / Fourni jusqu'a épuisement du stock

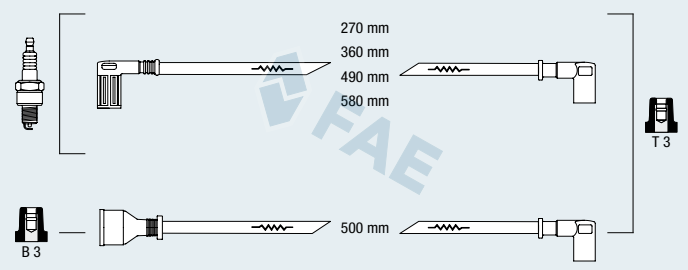

ROVER GROUP			
Maestro 1.6, 2.0	1983-89		
Maestro 1.6, 2.0	1989-95		
Montego 1.6, 2.0	1984-89		
Montego 1.6, 2.0, 2.0 i	1989-95		
216 1.6 102 cv.	1985-91		
216 SE 1.6 82-90 cv.	1984-90		
820 2.0 Carb.	1988-91		

**Ref. 83870**

Supplied up to exhausting stock / Suministrado hasta agotar existencias / Fourni jusqu'a épuisement du stock

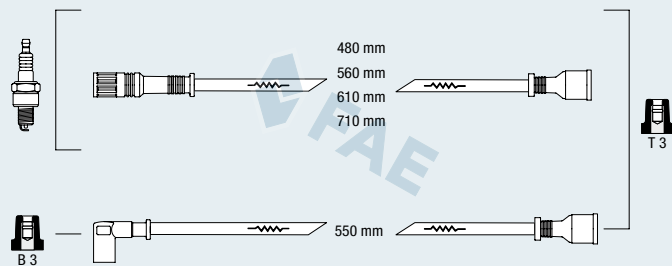

FIAT		FIAT Cont.	
Croma 1.6 1125933->	1989 ->	X 1/9 1498 cc.	1978-83
Croma 2.0 CHT	1985-90	LANCIA	
Croma 2.0 i.e.	1985-92	Beta 1.6, 1.8	1973-78
Croma 2.0 i.e. Turbo	1988-92	Beta 2.0	1973-85
Panda 45	1982-86	Delta 1600 GT, IE	1982-93
Panda 750 Young	1988 ->	Delta 1600 HF Turbo	1982-93
Panda 900, ACB	1985 ->	Prisma 1.6, 1.6 ie	1983-89
Regata 1.1, 1.3	1988-90	Prisma 2.0 ie 4WD	1985-89
Strada/Ritmo II (CH,S,USA)	1982-83	Thema 2.0 ie, 2.0 ie Turbo	1984-91
Tipo 1.6 2ACT	1989-91	Trevi 2.0, 2.0 i	1980-85

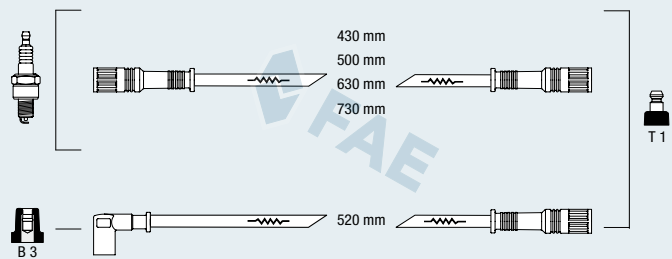
Ref. 83890

FIAT		FIAT Cont.	
Palio 1.1 i	1998 ->	UNO 60 Fire 1108	1989-93
Panda 750 CL, S	1986-93	LANCIA	
Panda 900	1986-93	Y10 1.0 Fire, 4WD	1985-91
Panda 1000 S, 4x4	1986-89	Y10 1.1 i.e	1989-92
Panda 1000 ie	1988-92	Y10 1.1 i.e 4WD	1989-92
Tipo 1.1 Fire, DGT	1989-93	Y10 1.1 i.e. Fire, 4WD	1989-95
UNO Mondo 1.0	1998 ->		
UNO 45 Fire 1000	1985-93		
UNO 45 1000 ie	1989-93		
UNO 1.1 ie S	1991-93		

Ref. 83900

Supplied up to exhausting stock / Suministrado hasta agotar existencias / Fourni jusqu'a épuisement du stock

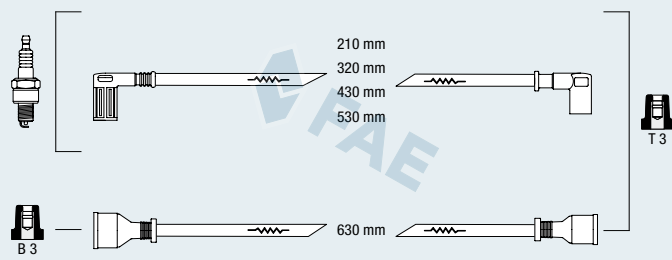

FIAT		LANCIA	
Regata 1.6	1983-90	Delta 1.3 ie	1982-92
Regata 1.6 ie	1988-90	Delta 1500	1983-92
UNO 45 903 cc.	1983-85	Prisma 1.5	1983-88
UNO 55. 70. Antipollution	1983-90		
UNO 70 SX 1.3 i	1983-89		
UNO 75 SX 1.5 i	1983-89		
UNO Turbo IE	1985-93		

Ref. 83910

Supplied up to exhausting stock / Suministrado hasta agotar existencias / Fourni jusqu'a épuisement du stock

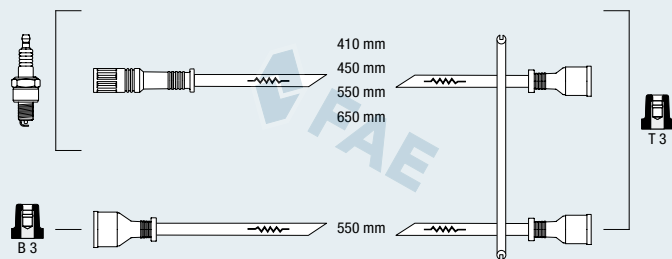

FIAT		SKODA	
Florino 903-1050 cc.	1977-87	Favorit	1989 ->
Panda 35, 40, 45	1979-86	S100, S110, Coupé	1970-80
UNO 45 ES 900	1983-85	S105, S120, Estelle	1977-83
UNO 45 903 cc.	1986-93	Estelle MKII 105.120.130	1984 ->
FSO-POLSKI		SUBARU	
125 P 1300, 1500	1975 ->	1400. 1500. 1600. 1800	1976-84
LADA		1800 4WD Pick-up	1984-88
1200. 1300. 1500. 1600	1974-87		
LANCIA-AUTOBIANCHI			
A 112	1969-86		

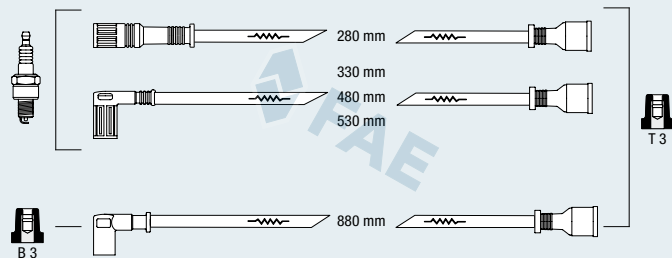
Ref. 83940

FIAT		LANCIA	
Regata 70 Mare	1987-90	Delta I 1.1	1986-90
Tempra 1.4, 1.4 SX	1990-96		
Tipo 1.4, 1.4 AGT, DGT	1988-92		
Tipo 1.4 ie AGT, DGT	1990-96		
UNO 55 1100	1983-88		
UNO 60 1116, Selecta	1986-93		
UNO 70 1300	1983-88		
UNO SX 1300	1983-88		

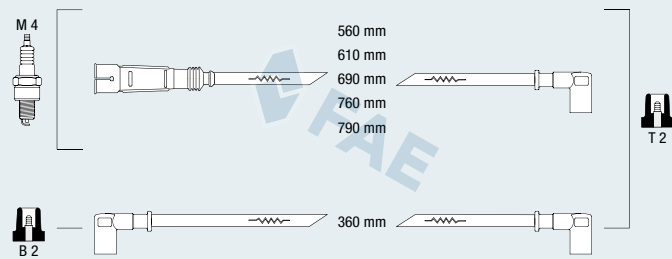
Ref. 83950

AUDI		VOLKSWAGEN	
80 2.3 E 5 cil.	1991-94	Passat 2.0 Syncro Variant	1984-88
90 5 cil.	1985-91	Passat 2.0, Variant	1983-88
100 5 cil.	1985-94	Passat 2.2 Variant Syncro	1985-88
200 5 cil.	1985-91	Passat 2.2, Sedan, Variant	1985-88
Coupé 5 cil.	1985-88	Passat 2.2, Variant	1985-88
		Santana 2.0	1983-84



Ref. 83960

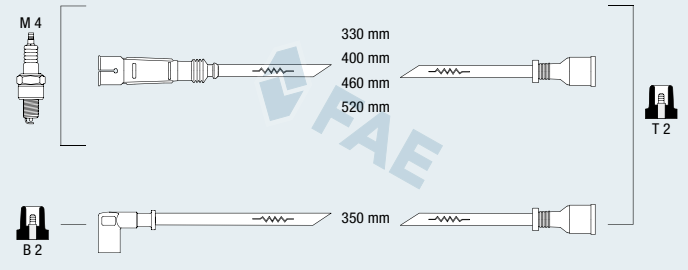

AUDI		VOLKSWAGEN	
80 4 cil.	1984-94	Passat 1.6, 1.8. 4 cil.	1984-88
100 4 cil.	1984-94	Santana 1.6, 1.8. 4 cil.	1984-88
Coupé 4 cil.	1985-94	Scirocco 1.3	1979-80
		Scirocco 1.5	1974-75
		Scirocco 1.6	1975-79

Ref. 83979

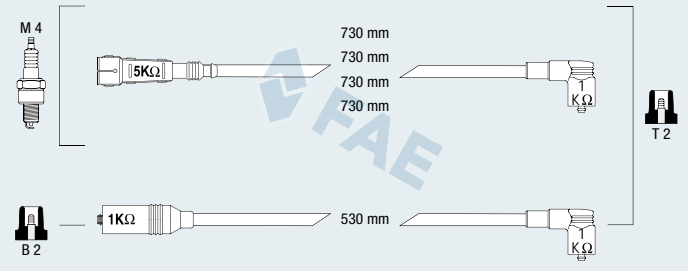

SEAT		VOLKSWAGEN	
Ibiza II 1.3 i	1993-99	Polo 1.0 Classic	1985-86
		Polo 1.0 Coupe	1982-86
		Polo 1.0 Kat, Coupe	1989-94
		Polo 1.0, Coupe	1985-92
		Polo 1.3 Classic	1985-87
		Polo 1.3 Coupe	1983-87
		Polo 1.3 Kat Classic	1987-94
		Polo 1.3 Kat, Coupe	1987-94
		Polo 1.3, Classic, Coupe	1983-88
		Polo 1.3, Coupe	1982-89

Ref. 83981

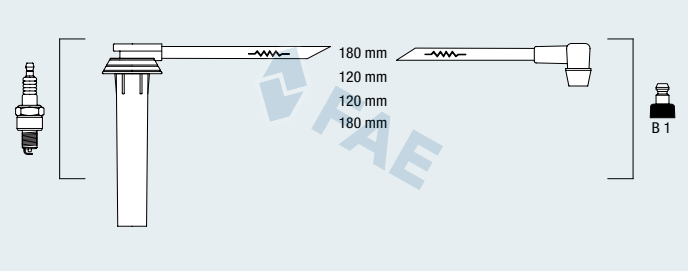

CHRYSLER			
Grand Voyager 2.0	1996-01		
Neon 1.8, 2.0	1994 ->		
Sebring 2.0	2001 ->		
Stratus 2.0 16V	1995 ->		
Voyager 2.0	1996-01		

Ref. 83982

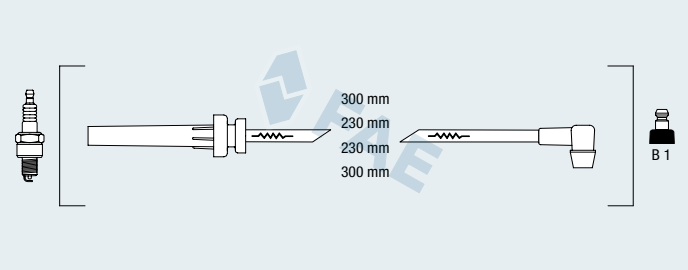

CHRYSLER			
Grand Voyager 2.4	1996-01		
Neon 2.4 16V	1994-99		
Stratus 2.4 16V	1995-01		
Voyager 2.4	1996-01		

Ref. 83984

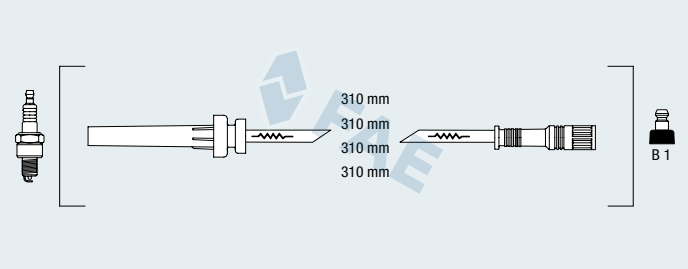

CHRYSLER			
PT Cruiser 2.0 i	2000->		
PT Cruiser 2.4 i	2000->		
PT Cruiser Cabriolet 2.4 i	2004->		
PT Cruiser Cabriolet 2.4i GT	2004->		
PT Cruiser GT 2.4 i	2003->		
Sebring Cabriolet 2.0 i	2001->		
Sebring Cabriolet 2.4 i	2000->		
Voyager III 2.4 i	2000->		

Ref. 83985

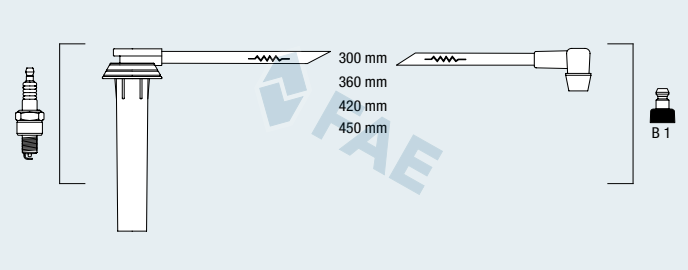

CHRYSLER		MINI	
Neon II 1.6	2001 ->	Mini Cooper Cabrio	2004 ->
Neon II 2.0 16V	1999 ->	Mini Cooper S Cabrio	2004 ->
PT Cruiser 1.6	2001 ->	Mini Cooper S, Cabrio	2002-06
		Mini Cooper, Cabrio	2001-06
		Mini John Cooper Works Cabrio	2004 ->
		Mini One Cabrio	2004 ->
		Mini One, Cabrio	2001-06
		Mini Works, John Cooper Cabrio	2003-06



Ref. 85020

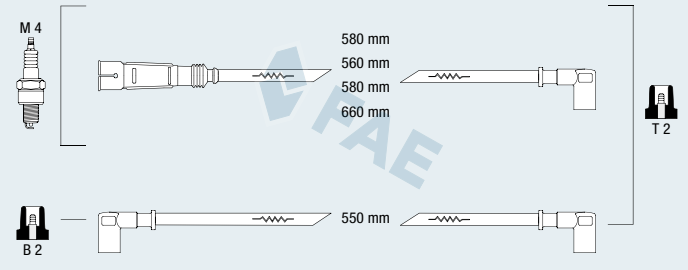

BMW			
315 (E30)	1984-88		
316 (E30)	1982-88		
318 i (E30)	1982-88		
320 (E30)	1982-88		
518 (E28)	1981-88		
518 i (E28)	1981-88		
Engines/Motores/Moteurs: 4 cil.			

Ref. 85040

Supplied up to exhausting stock / Suministrado hasta agotar existencias / Fourni jusqu'a épuisement du stock

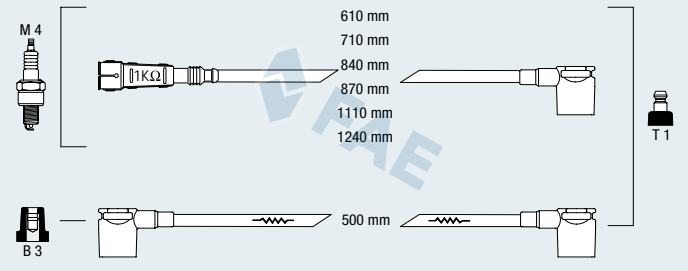

MERCEDES BENZ			
280 K-Jetronic	1981-85		
280 E, CE, TE, Typ 123	1981-85		
280 GE 4x4 Typ 460	1979-89		
280, S, SE, SEL, Typ 126	1980-85		
280 SL, SLC, Typ 107	1981-85		
Engines/Motores/Moteurs: 6 cil. M110 K-Jetronic			

Ref. 85050

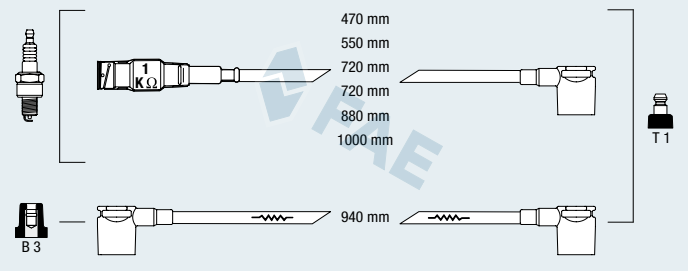

MERCEDES BENZ		MERCEDES BENZ Cont.	
190 E 2.6	1986-89	300 E Sedan	1985-85
250 T Kombi	1978-82	300 GE	1990 ->
260 E 4-matic Sedan	1986-89	300 GE, Cabrio	1989-97
260 E Sedan	1985-89	300 TE 4-matic Kombi	1986-89
260 TE FGST Kombi	1985-89	300 TE Kombi	1986-89
280 E Sedan	1976-85	S 260 SE (W126)	1985-91
280 GE	1984-89	S 300 SE,SEL (W126)	1985-89
280 TE Kombi	1977-85	SL 300 SL	1985-89
300 CE Coupe	1987-93	Engines/Motores/Moteurs: 6 cil. M103	
300 E 4-matic Sedan	1986-92		

Ref. 85051 NEW

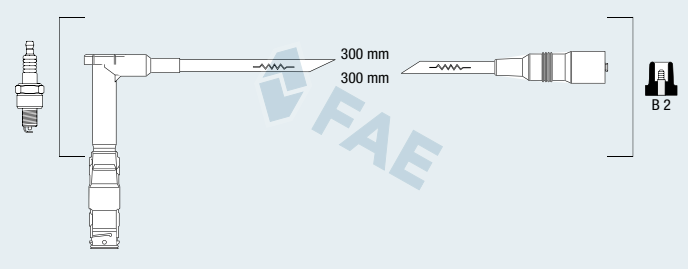

MERCEDES BENZ		MERCEDES BENZ Cont.	
C 180, T	1993-00	SLK 230 Kompressor	1996-00
C 200	1994-00	Sprinter 3-t 314, 4x4	1995-06
C 230 T Kombi	1996-98	Sprinter 4-t 414, 4x4	1996-06
CLK 200 Kompressor, Cabrio	1997-00	V 200	1997-03
CLK 200, Cabrio	1997-02	V 230	1996-03
CLK 230 Kompressor, Cabrio	1997-00	Vito 113 2.0	1996-03
E 200, T Kombi	1995-00	Vito 114 2.3	1996-03
E 230, T Kombi	1995-97	VOLKSWAGEN	
SLK 200	1996-00	LT 28-35 II 2.3	1996-06
SLK 200 Kompressor	1996-00	LT 28-46 II 2.3	1996-06

Ref. 85052 NEW

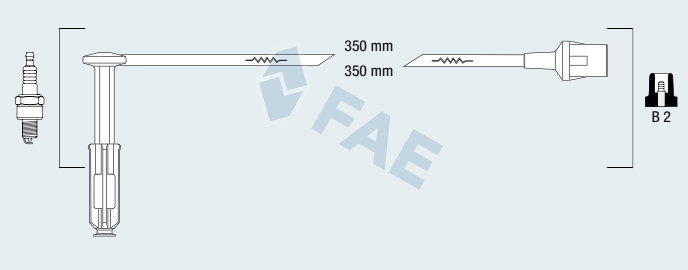

DAEWOO		SSANGYONG	
Musso 2.3	1999 ->	Musso 2.3	1996 ->
MERCEDES BENZ			
E 200 Kompressor, T Kombi	1997-02		
E 230, T Kombi	1995-97		
ML 230	1998-05		
SLK 200 Kompressor	2000-04		
Sprinter 2-t 214 NGT	2000-06		
Sprinter 2-t 314 NGT	2000-06		

Ref. 85059 NEW

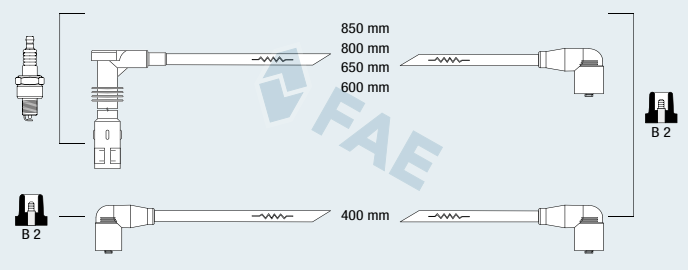

SEAT		VOLKSWAGEN	
Cordoba 1.8 i 16V	1993-96	Corrado 2.0 i 16V	1991-95
Cordoba 2.0 i 16V	1996-99	Golf III 2.0 GTI 16V	1992-97
Ibiza II 1.8 i 16V	1993-96	Passat 2.0 16V, Variant	1994-96
Ibiza II 2.0 i 16V	1996-99		
Toledo I 2.0 i 16V	1993-99		

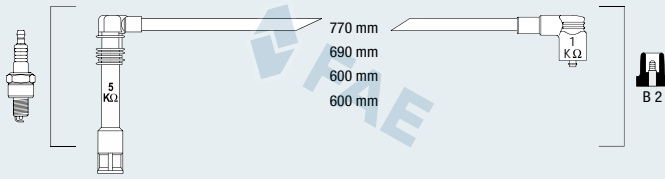
**Ref. 85061**

AUDI		SKODA	
A3 1.8 i	1996 ->	Octavia 1.8 i	1996 ->
A3 1.8 i Quattro	1998 ->	Octavia Combi 1.8	1998 ->
		VOLKSWAGEN	
		Passat 2.0	2000-00
		Bora 1.8	1998-05

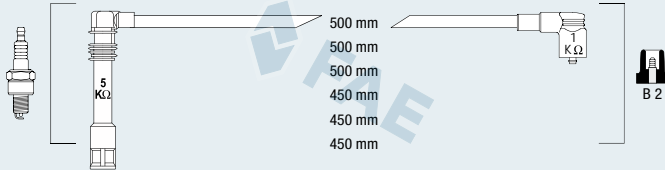
Ref. 85062

AUDI		VOLKSWAGEN	
A4 2.4, Avant, Quattro	1997-01	Passat 2.8, 4motion	2000-05
A4 Cabriolet 2.4	2002 ->	Passat 2.8 V6	1996-00
A4 2.8, Avant, Quattro	1996-01	Passat Familiare 2.8, 4motion	1996-00
A6 2.4	1997-05	Passat Variant 2.8 V6	1997-00
A6 2.8, Avant, Quattro	1995-97		
A8 2.8, Quattro	1996-02		
SKODA			
Super B2.8 V6	2002 ->		

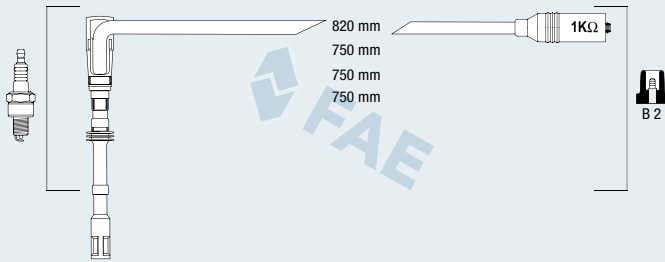
Ref. 85065

AUDI		VOLKSWAGEN	
A3 1.8 i	1996 ->	Bora 1.8 i	1998-05
A3 1.8 i Quattro	1998 ->	Bora 1.8 i 4motion	1999-05
SEAT		Bora Familiare 1.8 4motion	1999-05
Leon 1.8 i 20V	1999 ->	Golf IV 1.8 i	1997-05
Toledo II 1.8 i 20V	1999-06	Golf IV 1.8 i 4motion	1998-05
SKODA		Golf IV Variant 1.8 i 4 motion	1999-05
Octavia 1.8 i 20V	1996 ->		
Octavia Combi 1.8 i 20V	1998 ->		

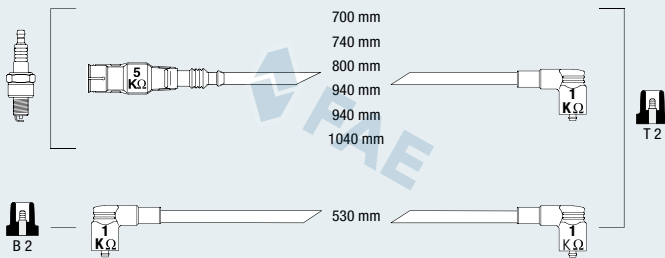
Ref. 85070

FORD		VOLKSWAGEN	
Galaxy 2.8 i V6 (DOHC)	1995-00	Corrado 2.9 VR6 (ABV)	1991-95
SEAT		Golf 2.8 VR6 (AAA)	1992-97
Alhambra 2.8 VR6	1997 ->	Passat 2.8 VR6 (AAA)	1992-97
		Sharan 2.8 VR6 (AAA)	1995-00
		Vento 2.8 VR6 (AAA)	1992-98

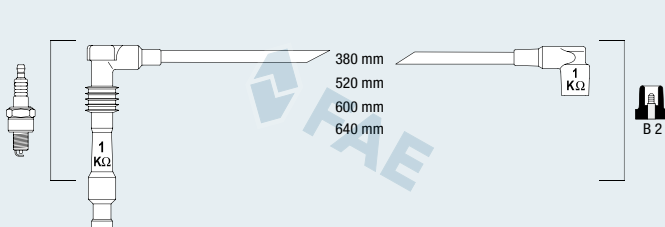
Ref. 85080

OPEL		VAUXHALL	
Astra 1.4 i 16V (X14XE)	1996 ->	Astra 1.4 i 16V	1996 ->
Calibra 2.0 i 16V (C20XE)	1994 ->	Calibra 2.0 i 16V	1994 ->
Corsa 1.4 i 16V (X14XE)	1995-00	Cavalier 2.0 i 16V	1993-96
Corsa 1.6 i 16V (C16XE)	1993-00	Cavalier 2.0 i 16V Cat.	1993-96
Tigra 1.4 i 16V (X14XE)	1994-00	Corsa B 1.4 i 16V	1995 ->
Tigra 1.6 i Cat. (C16XE)	1994-98	Corsa B GSI 16V	1993 ->
Tigra 1.6 i 16V (X16XE)	1994-98	Tigra 1.4 i 16V	1994-00
Vectra 2.0 i 16V (C20XE)	1993-96	Tigra 1.6 i 16V	1994-98
Vectra 2.0 i 16V (20XE)	1993-96		

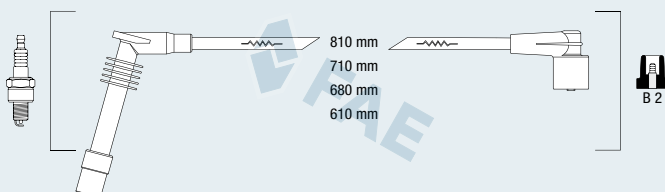
Ref. 85083 NEW

OPEL		VAUXHALL	
Frontera A 2.0 i Sport	1992-98	Frontera Mk I 2.0	1995-98
		Frontera Mk I 2.0 i Sport	1992-98



Ref. 85084

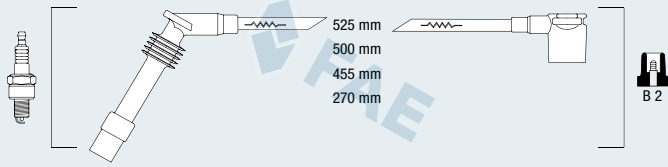

OPEL			
Astra G 1.6 i	1998-00		
Combo 1.4 i	1994-99		
Corsa B 1.4 i, Si	1993-00		
Corsa C 1.6 i	2001 ->		
Meriva 1.6 i	2003 ->		
Vectra B 1.6 i	1995-02		

Ref. 85085

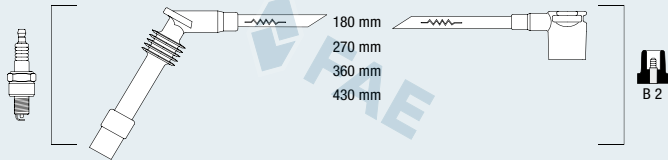

OPEL		VAUXHALL	
Astra 1.4 i (14SE, C14SE)	1995-98	Astra 1.4 i (14SE, C14SE)	1995-98
Astra 1.6 i (X16SZ)	1995-01	Astra 1.6 i (X16SZ)	1995-01
Combo 1.2 i (X12SZ)	1995-01	Combo 1.2 i (X12SZ)	1995-01
Corsa B 1.2 i (X12SZ)	1995-00	Corsa B 1.2 i (X12SZ)	1995-00
Corsa B 1.4 i (X14SZ)	1997-00	Corsa B 1.4 i (X14SZ)	1997-00
Corsa B 1.4 i (C14SE)	1995-00	Corsa B 1.4 i (C14SE)	1995-00
Tigra 1.2 i (X12SZ)	1994 ->	Tigra 1.2 i (X12SZ)	1994 ->
Tigra 1.4 i (C14SE)	1994 ->	Tigra 1.4 i (C14SE)	1994 ->
Vectra A 1.6 i (X16SZ)	1993-95	Vectra A 1.6 i (X16SZ)	1993-95
Vectra B 1.6 i (X16SZR)	1996 ->	Vectra B 1.6 i (X16SZR)	1996 ->

Ref. 85087

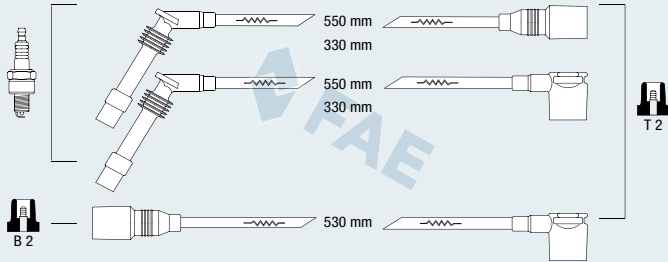

OPEL		VAUXHALL	
Astra 1.6 i	1994-96		
Astra 2.0 i	1991-94		
Calibra 2.0 i	1989-96		
Vectra 1.6 i	1993-95		
Vectra 1.6 i GL	1992-96		
Vectra 1.8, 1.8 i	1988-95		
Vectra 2.0 i	1988-95		

Ref. 85090

Supplied up to exhausting stock / Suministrado hasta agotar existencias / Fourni jusqu'a épuisement du stock

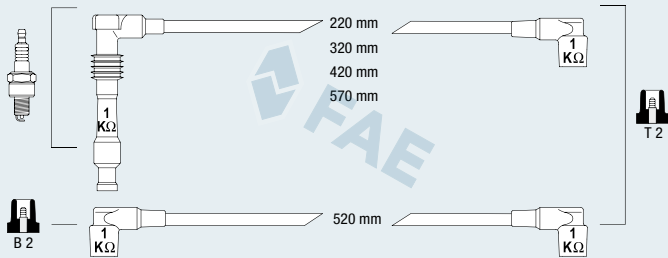

OPEL		VAUXHALL	
Astra GSI 16V ->N14002934	1992-93	Astra GSI 16V	1992-93
Calibra GSI 16V ->N199999	1992-94	Belmont GSI 16V	1990-91
Calibra 2.0i Turbo (C20LET)	1993-97	Calibra GSI 16V	1992-94
Kadett GSI 16V 14180385->	1990-91	Cavalier GSI 16V	1989-92
Vectra GSI 16V 14028514->	1989-93		

Engines/Motores/Moteurs:
C20XE.

Ref. 85100

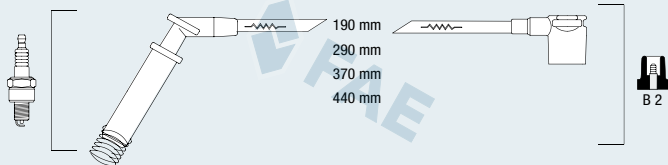

OPEL		VAUXHALL	
Astra F 1.4 i Classic Caravan	1998-05	Astra 1.4 i, 1.6 i	1992-98
Astra F 1.4 i Classic CC	1998-02	Corsa B 1.2 i Merit	1993-00
Astra F 1.4 i Classic Sedan	1998-02	Corsa B 1.4 i GLS, SRI	1993-00
Astra F 1.4, Caravan, CC	1992-98	Corsa B 1.4 i Combo	1993-00
Astra F 1.6 i Van	1991-93		
Astra F 1.6 i, Caravan, CC	1991-98		
Astra F 1.6, Caravan, CC	1995-98		
Combo 1.4	1994-01		
Vectra A 1.6 i	1988-90		
Vectra A 1.6 i, CC	1993-95		

Ref. 85105

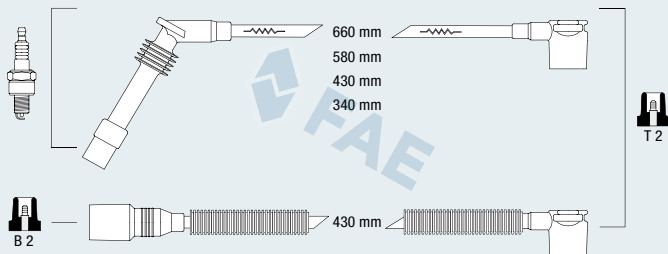

OPEL		OPEL Cont.	
Astra 1.4	1991-05	Tigra 1.4 i (X14NZ)	1994 ->
Astra 1.6	1998-00	Vectra A 1.4 S, CC	1988-92
Combo 1.2	1994-01	Vectra A 1.6, CC	1988-93
Combo 1.4	1994-01		
Corsa B 1.2 i (12NZ,C12NZ)	1994-97		
Corsa B 1.4 i (X14NZ)	1994-96		
Kadett E 1.4 i, Cabrio, Caravan, CC	1990-91		
Kadett E 1.4 S, Caravan, CC, Cabrio	1989-91		
Kadett E 1.6 S, Caravan, CC, Combo	1986-91		
Tigra 1.2 i (12NZ)	1994 ->		

VAUXHALL

Corsa B 1.2 i (12NZ,C12NZ)	1994-00
Corsa B 1.4 i (X14NZ)	1994-00
Tigra 1.2 i (12NZ)	1994 ->
Tigra 1.4 i (X14NZ)	1994 ->

Engine/Motor/Moteur:
Nr. 19334657->.

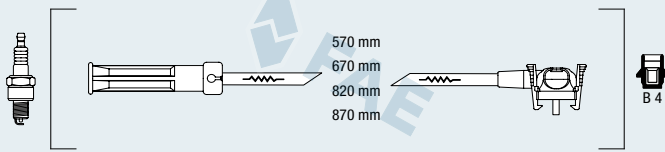
**Ref. 85110**

FORD			
Courier 1.3, 1.3 i. (HCS)	1991-95		
Escort 1.3 CLX (HCS)	1992-96		
Escort 1.4, 1.6, XR3i	1990-92		
Escort 1.4 i, 1.6 i. (CVH)	1992-95		
Fiesta 1.1, 1.3. (HCS)	1989-92		
Fiesta 1.3 i CLX (HCS)	1992-96		
Fiesta 1.6 i, XR2i. (CVH)	1989-94		
Orion 1.3 CL (HCS)	1990-92		
Orion 1.4, 1.6, 1.6 i.(CVH)	1990-92		
Orion 1.4 i, 1.6 i. (CVH)	1992-96		

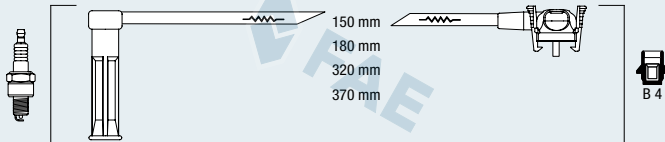
Ref. 85111

FORD		MAZDA	
Courier 1.4 i 16V	1996-98	121 1.3 i 16V	1996-98
Fiesta 1.25 i, Ghia	1996-98		
Fiesta 1.4 i 16V	1996-98		
Puma 1.4 i 16V	1998-98		
Puma 1.7 i 16V	1997-98		
Engines/Motores/Moteurs: ZETEC-SE.			

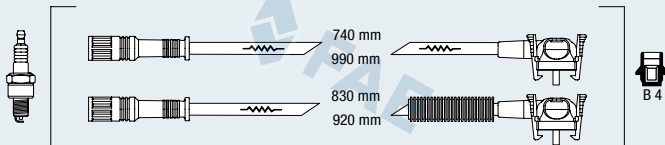
Ref. 85112

FORD		MAZDA	
Courier 1.3 i	1995 ->	121 1.3 i 8V	1996 ->
Fiesta 1.1 i	1996 ->		
Fiesta 1.3 i	1995 ->		
Fiesta Van 1.3 i	1995 ->		
KA 1.0 i	1997 ->		
KA 1.3 i	1996 ->		
Engines/Motores/Moteurs: CFI 8V.			

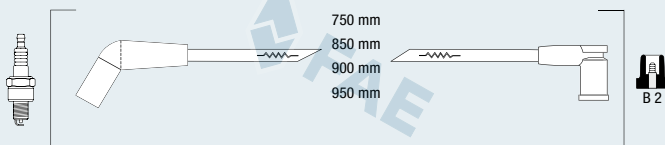
Ref. 85114 NEW

FORD		MAZDA	
Fiesta 1.3 Furgón	1996 ->	121 III 1.3	1996 ->
Fiesta IV 1.3 i	1995-02		
Ka 1.3 i	1996-02		
Ka 1.3 i, Van	1996-08		

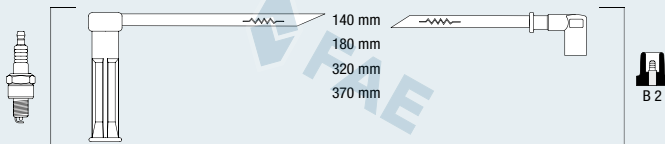
Ref. 85115

FORD		MAZDA	
Fiesta 1.25 i	1998 ->	121 1.3 i 16V	1998 ->
Fiesta 1.4 i 16V	1998 ->		
Focus 1.4 i 16V	1998-04		
Focus 1.6 i 16V	1998-04		
Puma 1.4 i 16V	1998 ->		
Puma 1.7 i 16V	1998 ->		
Engines/Motores/Moteurs: ZETEC-SE.			

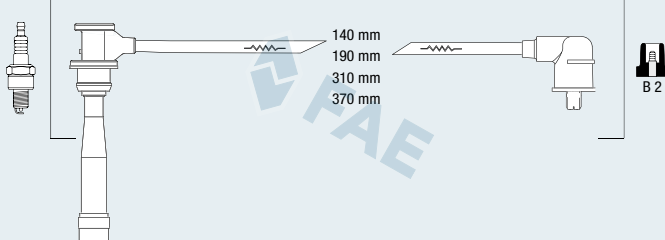
Ref. 85116 NEW

FORD		MAZDA	
Fiesta V 1.4 16V	2001 ->	2 1.4	2003 ->
Fiesta V 1.6 16V	2001 ->	2 1.6	2003 ->
Focus C-Max 1.6, Ti	2003-07		
Focus II 1.4, Sedan, Turnier	2004 ->		
Focus II 1.6, Cabrio, Sedan, Turnier	2004 ->		
Focus II 1.6 Ti, Sedan, Turnier	2004 ->		
Fusion 1.4	2002 ->		
Fusion 1.6	2002 ->		
Mondeo IV 1.6 Ti, Sedan, Turnier	2007 ->		
Puma ST 160	1999 ->		



Ref. 85120

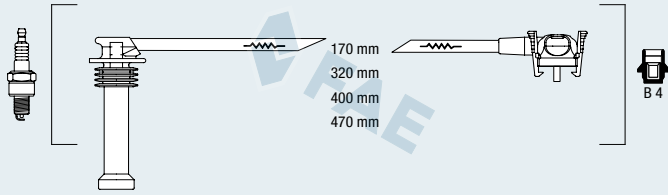

FORD			
Escort 1.8 i 16V 115 cv.	1992 ->		
Escort XR3i 16V 130 cv.	1992 ->		
Fiesta 1.8 i 16V S, XR2i	1992 ->		
Mondeo 1.6 i CLX 16V	1993 ->		
Mondeo 1.8 i CLX 16V	1993 ->		
Mondeo 2.0 i GLX 16V	1993-98		
Orion 1.6 i 16V	1992-93		
Orion 1.8 i Si Ghia 16V	1992-93		

Engines/Motores/Moteurs:
Zetec.

Ref. 85125

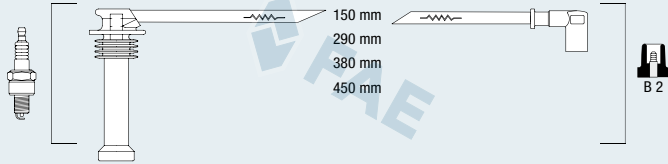

FORD		FORD Cont.	
C-Max 1.6	2007 ->	Mondeo 1.8 i 16V	1998-00
Cougar 2.0 i 16V	1998 ->	Mondeo 2.0 i 16V	1998-00
Fiesta 1.25 Van	2009 ->	Engines/Motores/Moteurs:	
Fiesta V 1.25 16V	2002 ->	ZETEC.	
Focus 1.8 i 16V	1998-04	MAZDA	
Focus 2.0 i 16V	1998-04	2.1.25, 1.4, 1.6	2003 ->
Fusion 1.25	2004 ->	VOLVO	
Fusion 1.4	2002 ->	C30 1.6	2006 ->
Grand C-Max 1.6	2010 ->	S40 II 1.6	2005 ->
Mondeo 1.6 i 16V	1998 ->	V50 1.6	2005 ->

Ref. 85126 NEW

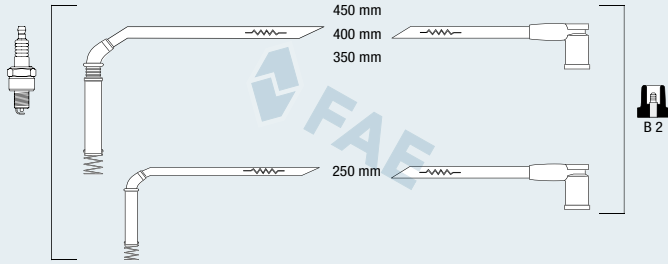

FORD			
Fiesta V 1.25 16V	2002 ->		
Fiesta V 1.3	2001 ->		
Fiesta V 1.3, Van	2001 ->		
Fusion 1.25	2004 ->		
Ka 1.3 i	1998-08		
Ka 1.3 i, Van	1996-08		
Ka 1.6 i	2003-08		

Ref. 85130

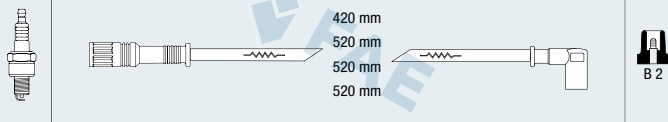

SEAT			
Marbella	1993-97		
Terra	1993-96		

Engines/Motores/Moteurs:
Inj. Monopoint.

Ref. 85140

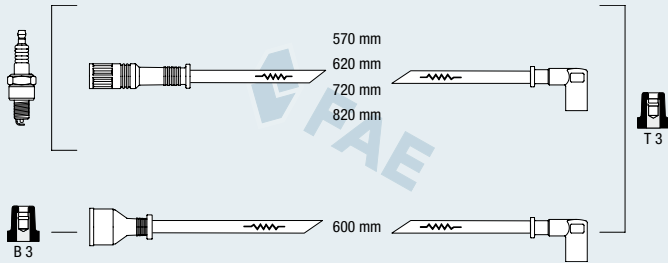

MAZDA		SUZUKI	
121 1.1, 1.3	1985-90	Alto 0.8 40 cv.	1981-92
323 (FWD) 1.1, 1.3, 1.5	1981 ->	ST90 797 cc.	1980-86
626 (FWD) 1600, 2000	1983-87	Swift 1.0 53 cv.	1983 ->
626 2.2 i LX, GLX. 115 cv.	1984 ->	Swift 1.3 GLX	1986-92
929 2.2 i 115 cv. (12V)	1984 ->	Swift 1.3 GS	1985-86
B 2000 Pick-up, Van	1985 ->	Swift 1.3 GTI	1983-92

TOYOTA			
Colt 1200, 1400, 1600	1979-84	Carina 1.6	1970-83
Colt 1300, 1500	1989-92	Celica 1.6	1970-83
Colt 1500, 1600 Turbo	1984-89	Celica 2.0	1986-90
Colt 1600, 1800	1988-90	Corolla 1.6, 1.8	1971-82

NISSAN			
Cordia 1.6, 1.8, Turbo	1982-88		
Galant 1600, 2000	1978-88		
L 300 Van 1.6	1980-85		
Lancer 1600, 1800	1988-90		
Sapporo 1.6	1978-85		
Bluebird 1.6, 1.8	1980-84		
Cherry Europe 1.2,1.35,1.5	1983-85		
Prairie (M11) 2.0	1989-92		
Silvia 2.0 ZX	1984-86		
SUBARU			
Series L 1.6, 1.8	1984-89		

DAIHATSU		HONDA Cont.	
Charade 1.0 Turbo	1983-87	Prelude 1600, 1829	1979-85
Cuore, Domino	1986-90	HYUNDAI	
FSO-POLSKI		Pony 1.3, 1.5 GLX	1985-90
Polonez 1.5	1978-90	Stellar 1.4, 1.6, 2.0	1984-91
125P 1.3	1981-90	KIA	
HONDA		Pride 1.1, 1.3, Van	1991 ->
Accord 1.6, 1.8, 2.0	1973-86	Sephia 1.6 i SLX, GTX	1994 ->
Ballade 1.5 i	1981-89	Sportage 2.0 i	1994 ->
Civic 1200, 1250, 1500	1972-84		
Civic Shuttle 1.5	1984-87		
Integra 1.5	1986-89		
Jazz 1.2	1984-86		

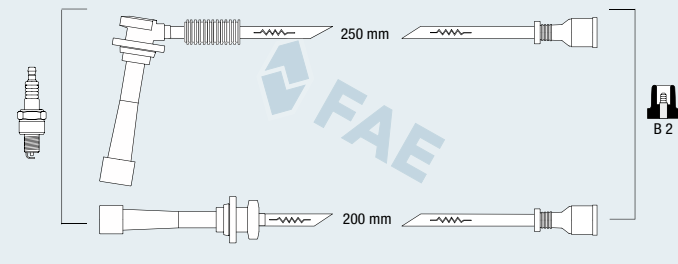
**Ref. 85145**

KIA			
Carens I 1.8 i	2000-02		
Carens II 1.8 i	2002 ->		
Clarus 1.8 i 16V	1996 ->		
Sephia 1.5, 1.8 i 16V	1995 ->		
Sephia II 1.5, 1.8 i 16V	1997-00		
Shuma 1.5, 1.8 i 16V	1997-04		
Spectra 1.5, 1.8 i 16V	1997 ->		

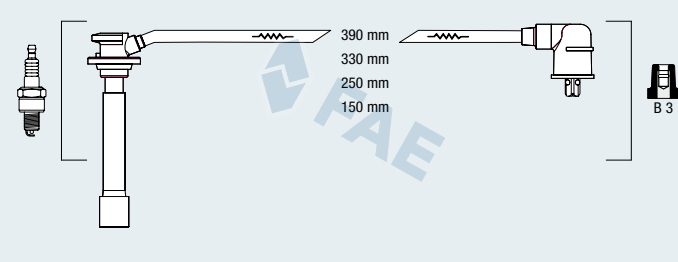
Ref. 85146 NEW

FORD		KIA	
Tourneo Connect 1.8 Di	2002 ->	Rio 1.5 16V Kombi	2002-05
		Rio 1.5 16V, Kombi	2000-05
		Shuma II 1.6, Sedan	2001-04

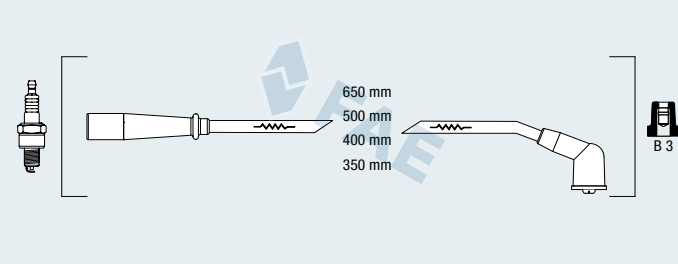
Ref. 85147 NEW

KIA			
Rio 1.3, Kombi	2000-05		

Ref. 85150

Supplied up to exhausting stock / Suministrado hasta agotar existencias / Fourni jusqu'a épuisement du stock

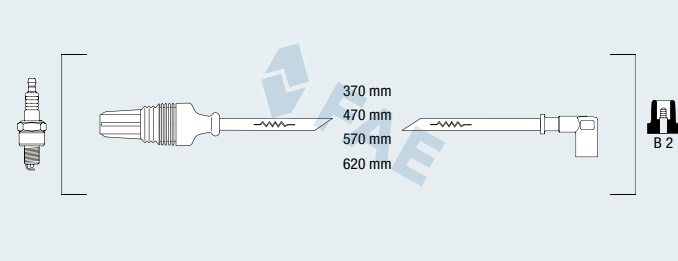

CITROËN		PEUGEOT	
AX 954 i, 1.1 i, 1.4 i	1992-93	106 1.0, 1.1, 1.4	1992-93
AX GTI 1360 cc.	1991-93	106 1.3 i KDX	1992-93
ZX 1.4 i PR-5905 ->	1992-93	106 XSI (TU3FJ)	1991-93
		205 1.0 i, 1.1 i	1991-94
		306 1.1 i, 1.4 i	1993-93
		306 1.6 i XR, XS, XT	1993-93
		405 1.4 i GL	1993-93
		Motors/Engines/Moteurs:	
		TU1M, TU3M, TU9M. Injection	
		Monopoint.	

Ref. 85160

Supplied up to exhausting stock / Suministrado hasta agotar existencias / Fourni jusqu'a épuisement du stock

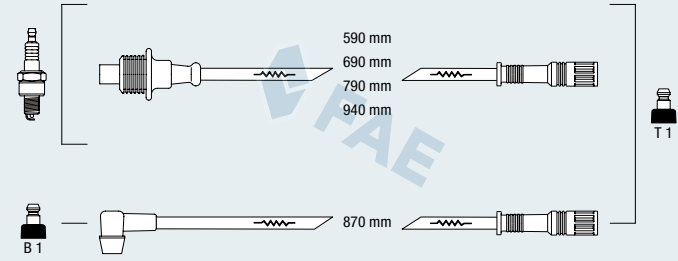

CITROËN		PEUGEOT	
BX 16 E, Break	1989-93	205 1.6 GTI (XU5J,XU5JA)	1990-94
BX 16, Break	1982-92	205 1.9 GTI (XU9JA/AZ)	1990-94
BX 19 Break, 4x4	1990-91	309 1.6 GTI (XU5JA)	1990-93
BX 19 E 4x4	1989-93	309 1.9 GTI (XU9JA/AZ)	1990-93
BX 19 E, Break, 4x4	1988-93	405 1.9 i 122 cv. (XU9JAZ)	1989-93
BX 19 GTi, 16V	1986-93		
BX 19 Gti, Break, 4x4	1988-93		
BX 19 Kat Break	1986-94		
BX 19, Break	1986-89		
ZX 1.9 i Export (XT)	1991-96		

Ref. 85190

Supplied up to exhausting stock / Suministrado hasta agotar existencias / Fourni jusqu'a épuisement du stock

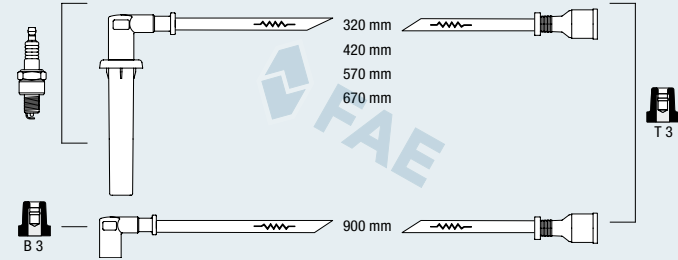

CITROËN		PEUGEOT	
C25 1.8 E	1987-94	505 GL, GR, SR	1980-89
C25 2.0 E	1981-94	505 2.0 (XN1A)	1980-89
C25 2.0, 4x4	1987-94	J 5, J 9	1984-94
FIAT			
Ducato 1.8	1982-88		
Ducato 1.8 Panorama	1982-88		
Ducato 2.0	1982-90		
Ducato 2.0 Panorama	1982-85		



Ref. 85200

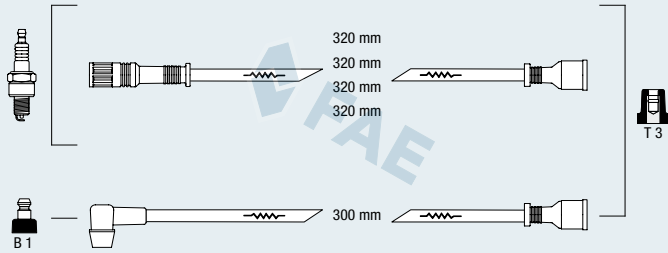

RENAULT			
Clio 1.2 i (C3G)	1995-96		
Twingo 1.2 i (C3G)	1993 ->		

Ref. 85210

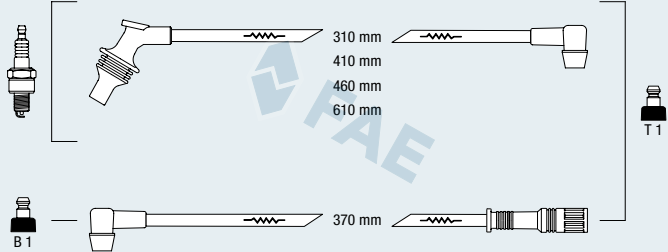

RENAULT			
Clio 1.8 i RT, S, Baccara	1990-96		
Clio 1.8 i (F3P-704)	1990-96		
Clio RSI (F3P-700)	1993-98		
R-19 1.8 i RN, RT, S, Bacc.	1992-95		
R-19 1.8 i (F3P-704)	1992-95		
R-19 RTI, RSI. (F3P-700)	1992-95		
Engines/Motores/Moteurs:			
F3P Monopoint/Multipoint.			

Ref. 85220

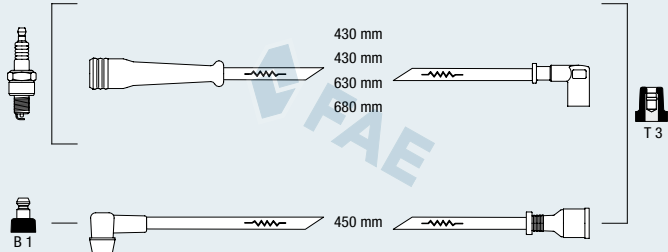

RENAULT			
Espace 2.0 i (J7R-768)	1991-96		
Espace 2.2 i (J7T-772)	1991-96		
R-21 GTX Brooken	1992-95		
R-21 TXE Manager	1992-95		
R-25 2.2 i (J7T)	1984-92		
Safrane 2.0 i (J7R-732)	1992-94		
Safrane 2.2 i (J7T-762)	1992-94		

Ref. 85230

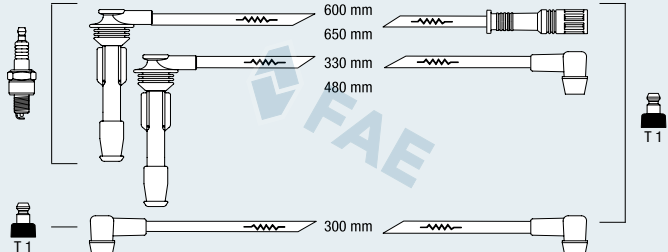

RENAULT			
Clio 16V (F7P)	1990-96		
Clio Williams (F7R)	1993-96		
R-19 16V (F7P)	1989-95		
R-19 Cabrio 16V	1991-95		

Ref. 85240

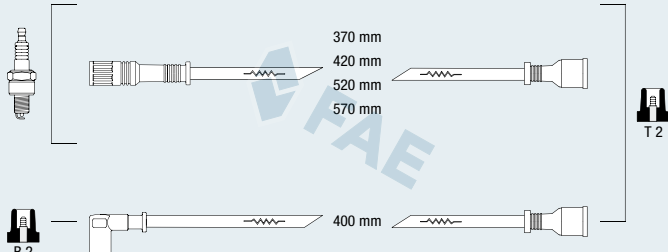

SEAT			
Marbella 850-903 cc.	1991-93		
Terra 903 cc.	1991-93		

Ref. 85250

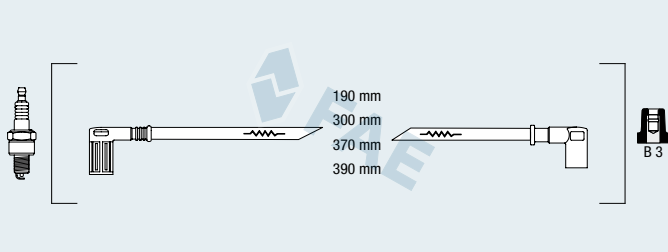

FIAT			
Cinquecento 898 ie, SPI	1992-98		
Cinquecento 903 ie, SPI	1992-98		
Panda 898 i SPI	1991-96		
Seicento 900 i	1998 ->		

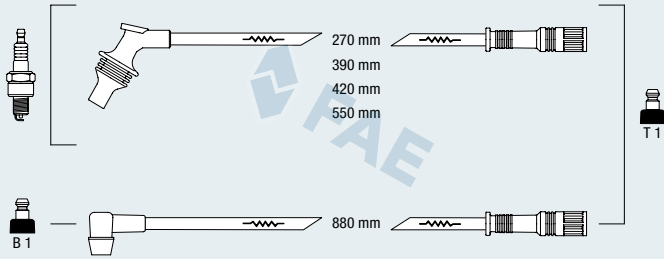
**Ref. 85260**

RENAULT			
Clio 1.8 i (F3P-755)	1993-96		
Laguna 1.8 i RN, RT, RXE	1994-98		
Laguna 1.8 i (F3P)	1994-98		
Laguna 2.0 i RN, RT, RXE	1994-98		
Laguna 2.0 i (F3R)	1994-98		
Scenic 2.0 i (F3R)	1996-98		

Ref. 85270

Supplied up to exhausting stock / Suministrado hasta agotar existencias / Fourni jusqu'a épuisement du stock

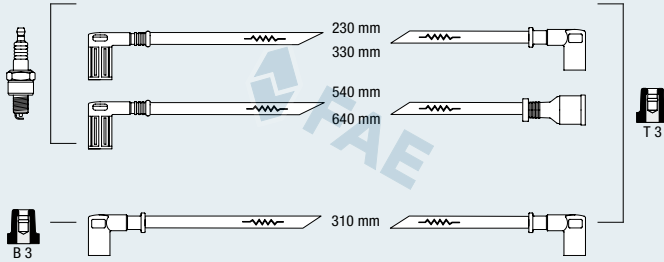

FIAT		LANCIA	
Tempra 1.4 i.e., S.W.	1992-96	Dedra 1.6 i.e.	1989-94
Tempra 1.6, S.W.	1990-93	Dedra 1.8 i.e.	1989-94
		Dedra 1.8 i.e., SW	1994-99

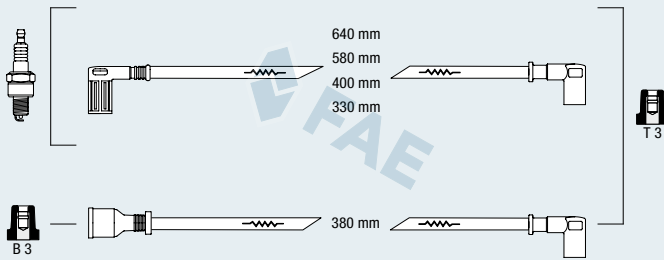
Ref. 85271

FIAT		LANCIA	
Tempra 1.4 i.e.	1992-94	Dedra 1.6 ie Cat.	1990-94
Tempra 1.6 i.e.	1990-94	Delta 1370 i	1993 ->
Tipo 1.4 i, 1.6 i	1987-92		
Tipo 1.4, 1.6 i.e.	1989-94		
Uno 1.4 i	1989-92		
Uno 70 1.4 i.e.	1989-94		
Uno 75 1.5 i.e.	1985-93		
Uno Mondo 1.4 i	1996->		
Engines/Motors/Moteurs: 8503995			

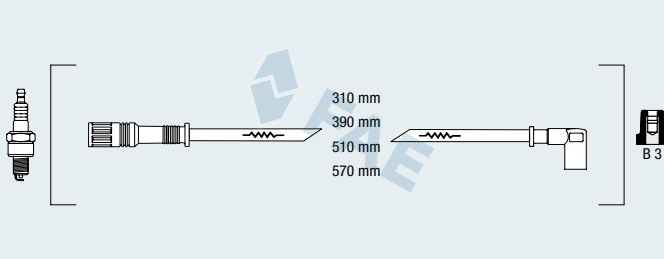
Ref. 85280

FIAT		LANCIA	
Cinquecento 1.1 i SPI	1994-98	Delta 1750 i	1993 ->
Palio 75 1.2 i, Weekend	1997 ->		
Panda 1.0, 1.1	1986-04		
Punto 55 1108 SPI	1993-99		
Punto 60 1242 SPI, MPI	1993 ->		
Punto 75 1242 SPI, MPI	1993 ->		
Seicento 1108	1998 ->		
Siena 1.0	1998 ->		
Siena 1.2	1998 ->		
Tipo 1.8	1993-95		

Ref. 85290

Supplied up to exhausting stock / Suministrado hasta agotar existencias / Fourni jusqu'a épuisement du stock

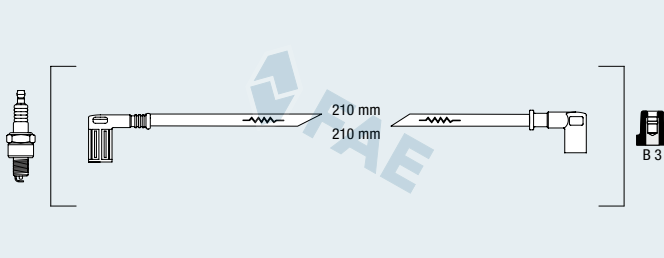

FIAT			
Cinquecento 704	1992-98		

Ref. 85320

Supplied up to exhausting stock / Suministrado hasta agotar existencias / Fourni jusqu'a épuisement du stock

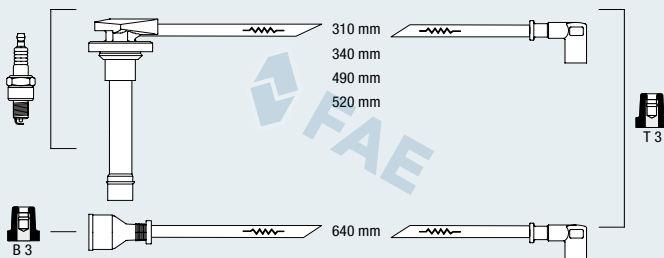

NISSAN			
Serena 1.6 i L, LX, SLX	1992 ->		
Serena 2.0 i SLX, SGX	1992 ->		
Vanette Cargo 1.6 i	1992 ->		
Engines/Motors/Moteurs: GA16DE, SR20DE.			



Ref. 85340

Supplied up to exhausting stock / Suministrado hasta agotar existencias / Fourni jusqu'a épuisement du stock

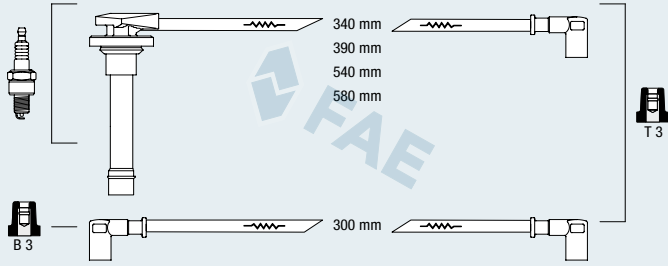

NISSAN		NISSAN Cont.	
100 NX 2.0 GTI	1991-94	Sunny III 1.6 i Traveller	1991-00
Primera 1.6 i Traveller	1990-98	Sunny III 2.0 GTI 16V	1990-95
Primera 1.6, Fastback	1990-93	Sunny III 2.0 GTI-R 4x4 Fastback	1990-95
Primera 2.0 16V, Fastback, 4x4	1990-96		
Primera 2.0 Fastback	1990-96		
Primera 2.0 GT	1990-96		
Sunny 1.6 i 16V Furgón	1992-00		
Sunny III 1.6 i	1990-95		
Sunny III 1.6 i 16V 4WD, Traveller	1990-95	Engines/Motores/Moteurs:	
Sunny III 1.6 i 16V, 4x4, Liftback	1992-00	GA16DS, SR20DE.	

Ref. 85350

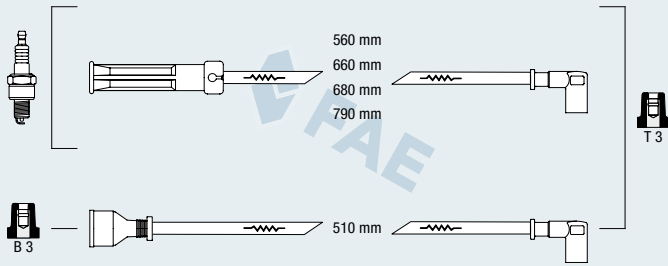

NISSAN			
Bluebird 1.8 GTI Turbo	1985-90		
Prairie 1.5 (E15S)	1982-89		
Sunny 1.3 L, LX, SLX	1984-88		
Sunny 1.5	1983-86		
Sunny 1.6 SLX	1986-88		
Sunny Coupe 1.6	1986-88		
PROTON			
Proton 1.3 GL, GLS	1989-91		
Proton 1.5 GL, GLS, SE	1989-91		
SAAB			
900 Turbo	1977-79		
95 Engines V4	1964-71		
96 Engines V4	1964-71		
99 1.7, 2.0	1970-80		
SUZUKI			
Alto 1.0 53 cv. (SOHC)	1993-02		
Swift 1.3 68 cv.	1984-01		
TOYOTA			
Starlet 1.1 (12V)	1986-89		
Starlet II 1.3i Si, XLI	1989-96		

DAIHATSU		MITSUBISHI	
Charade 1.3 (G102)	1988-99	Colt 1.3 Mirage	1983-89
Charade 1.6 EFI (G184)	1991-93	Cordia 1.6 75 cv.	1982-87
G.M.-BEDFORD		Galant 1.6	1982-85
Midi	1988 ->	Lancer 1200, 1400	1974-83
HYUNDAI		Space Wagon 1.8	1984-91
Pony 1.3	1990-94	Space Wagon 2.0	1984-91
Pony 1.5	1990-94	Tredia 1.4, 1.6	1982-86
Sonata 1.8 i, 2.0 i	1989-92	Tredia 1.6 Turbo	1982-86
Sonata 2.4 i	1990-92	Tredia 1.8	1984-88
ISUZU		Tredia 1.8 Turbo	1985-88
Trooper 2.3	1982-88		

Ref. 85360

Supplied up to exhausting stock / Suministrado hasta agotar existencias / Fourni jusqu'a épuisement du stock

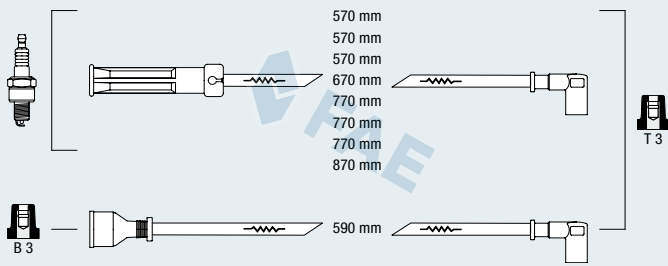

LAND ROVER		MG	
90/110 3.5 V8	1983-90	MGB GT 3.5	1973-76
Discovery I 3.5	1989-94	ROVER	
Discovery I 3.9 V8	1993-98	3500	1968-76
Discovery II 4.0 V8	1998-04		
Range Rover I 3.5	1970-81		
Range Rover I 3.5 Vogue	1981-90		
Range Rover I 3.9 Kat	1988-94		
Range Rover I 3.9 Vogue SEI	1988-94		
Range Rover II 3.9	1994-02		
Range Rover II 4.6	1994-02		

Ref. 85370

Supplied up to exhausting stock / Suministrado hasta agotar existencias / Fourni jusqu'a épuisement du stock

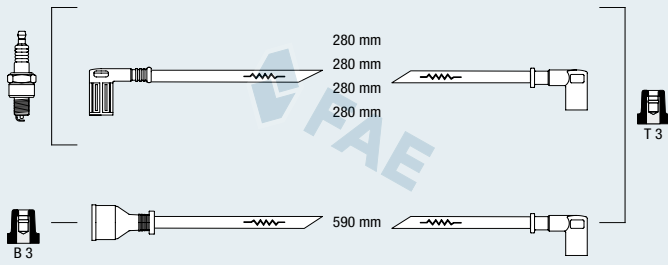

LAND ROVER		ROVER	
90 2.5	1980-90	Maestro 1.3	1984-89
110 2.2, 2.5	1983 ->	Montego 1.3	1980-84
Defender 2.5	1990 ->		
Land Rover (11A-B-111)	1968-71		
Land Rover 2.25	1971-85		

Ref. 85379 NEW

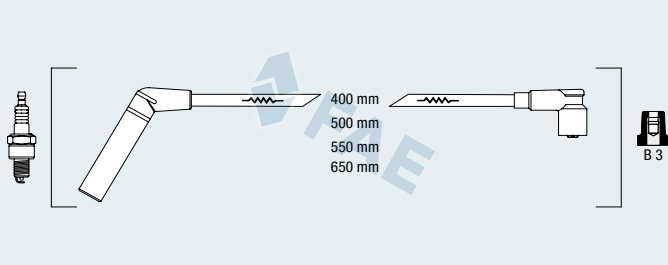

MITSUBISHI			
Colt IV 1.3 GLi 12V	1992-96		
Colt V 1300 GL, GLX	1996-00		
Colt V 1500	1995-05		
Lancer V 1.3	1992 ->		
Lancer V 1.5	1992-96		
Lancer VI 1.3 12V	1995-03		
Lancer VI 1.5 16V	1995-03		



Ref. 85380

Supplied up to exhausting stock / Suministrado hasta agotar existencias / Fourni jusqu'a épuisement du stock

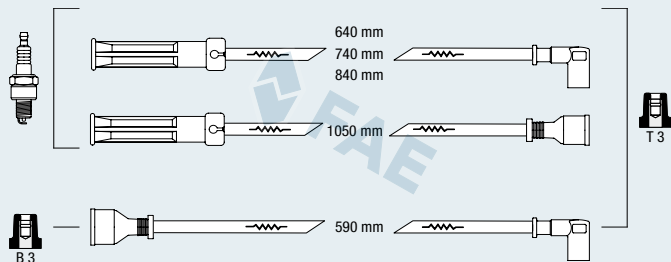

MITSUBISHI		MITSUBISHI Cont.	
Celeste 2000	1975-81	Shogun	1983 ->
Colt 1.4	1979-84	Sigma 1.6	1977-80
Galant 1.6	1985-89	Sigma 2.0	1976-85
Galant 2.0 GL, GLX, GTO	1979-87	Starion 2.0 Turbo	1982-85
L 200 Pick-up	1986-95	Starion Turbo 2.0	1982-88
L 300 Van	1985 ->		
Montero 2.3	1984-90		
Pajero 2.3	1984-90		
Sapporo 2.0 GL, GLS, GSR	1978-85		
Sapporo 2000 Turbo	1978-85		

Ref. 85381

Supplied up to exhausting stock / Suministrado hasta agotar existencias / Fourni jusqu'a épuisement du stock

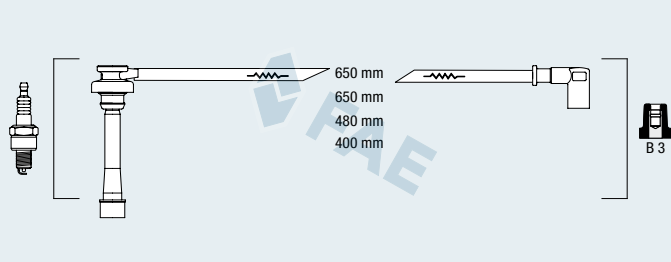

MITSUBISHI		MITSUBISHI Cont.	
Carisma 1.6, 1.8	1995-06	Space Wagon 2.0 i 16V	1992-98
Colt 1.6 i 16V	1991-94		
Expo LRV 1.8 i	1991 ->		
Galant 1.8 i 16V	1993 ->		
Galant 2.0 i	1993 ->		
Lancer 1.6 i 16V	1992-93		
Lancer Wagon 1.6 i 16V	1992 ->		
Mirage 1.8 i	1992 ->		
Space Runner 1.8 i 16V	1991-93		
Space Wagon 1.8 i 16V	1991-95		

Ref. 85382 NEW

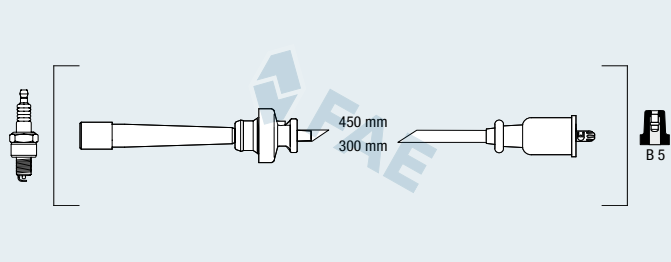

MITSUBISHI		MITSUBISHI Cont.	
Carisma 1.8, Sedan	1995-06	Space Star 1.6 16V	2001 ->
Galant VI 2.0	1996-00	Space Wagon 2.0, 4x4	1992-98
Galant VI 2.0 Station Wagon	1996-00	Space Wagon 2.4 GDI, 4x4	1998-04
Galant VI 2.4 GDI Station Wagon	1999-00		
Lancer 1.3 Sedan	2003 ->		
Lancer 1.6 Kombi	2003 ->		
Lancer 1.6 Sedan	2003 ->		
Montero iO 1.8	2001 ->		
Montero iO 1.8 GDI	1999 ->		
Space Runner 2.4 GDI	1999 ->		

Ref. 85383 NEW

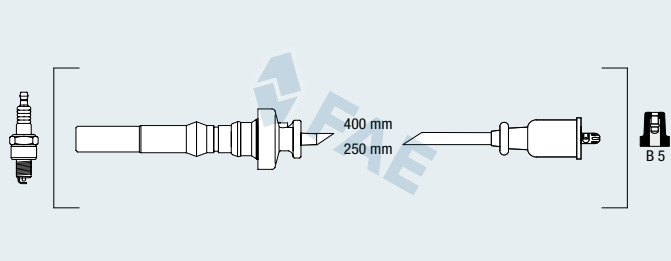

MITSUBISHI			
Colt V 1300	2000-05		
Lancer 1.3 Sedan	2003 ->		
Lancer 1.6 Kombi	2003 ->		
Lancer 1.6 Sedan	2003 ->		
Space Star 1.3 16V	1998 ->		
Space Star 1.6 16V	2001 ->		

Ref. 85384 NEW

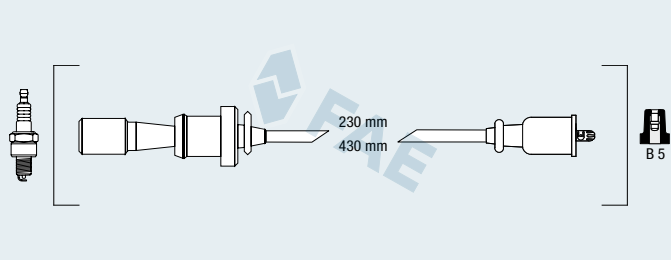

MITSUBISHI			
Lancer 2.0 Kombi	2003-07		
Lancer 2.0 Sedan	2003 ->		
Lancer VI 2.0 16V EVO IV / V / VI / VII	1996-03		
Outlander I 2.0	2003-06		
Outlander I 2.0 4WD	2003 ->		
Outlander I 2.0 Turbo 4WD	2004 ->		

Ref. 85390

Supplied up to exhausting stock / Suministrado hasta agotar existencias / Fourni jusqu'a épuisement du stock

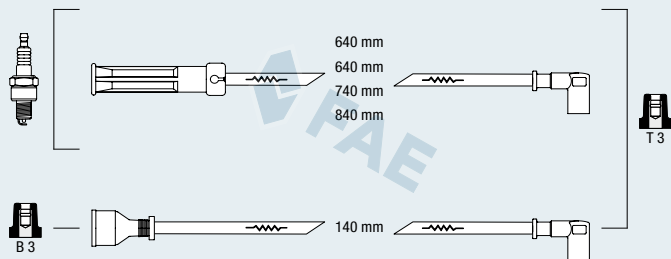

HONDA		HYUNDAI	
Civic IV 1.4 L, Sedan	1987-89	H100 2.4	1993-00
		Lantra I 1.5 i.e.	1990-95
		Lantra II 1.5 12V, Wagon	1996-00
		Pony 1.5 i	1989-95
		Pony 1.5, Sedan	1989-95
		S 1.5 i Coupe	1990-96



Ref. 85391

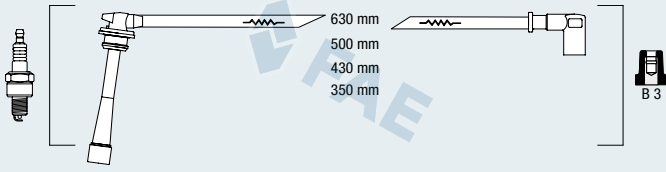

HYUNDAI		HYUNDAI Cont.	
Coupe 1.6 i 16V	1996-02	Matrix 1.8	2001 ->
Coupe 2.0 i 16V	1996-02	Santa Fe 2.4 16V	2001 ->
Elantra 1.6 i 16V	1995-00	Sonata 2.4 16V	1998-01
Elantra 1.8 i 16V	1995-00	Tiburon 1.6 i 16V	1999 ->
Elantra 2.0 i 16V	1997-00	Tiburon 2.0 i 16V	1999 ->
Elantra Station Wagon	1995-00		
Lantra 1.6 i 16V	1995-00		
Lantra 1.8 i 16V	1995-00		
Lantra 2.0 i 16V	1997-00		
Lantra Station Wagon	1995-00		

Ref. 85393 NEW

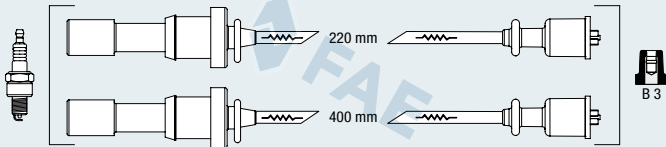

HYUNDAI		KIA	
Santa Fé 2.0	2001-06	Magentis 2.0	2001 ->
Santa Fé 2.4 16V, 4x4	2001-06		
Sonata IV 2.0 16V	1998-01		
Sonata IV 2.4 16V	1998-01		
Trajet 2.0	2000 ->		

Ref. 85394 NEW

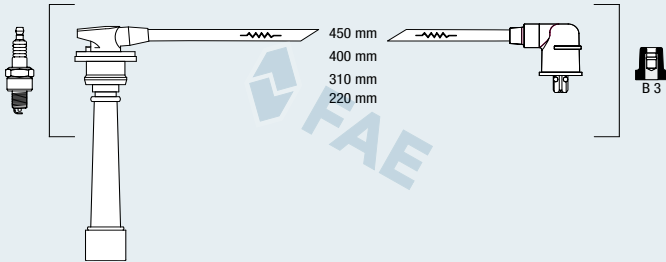

HYUNDAI			
Accent 1.5	2000 ->		
Accent 1.5 i 12V, Sedan	1994-00		
Accent 1.5 i 16V, Sedan	1995-00		
Elantra 1.6, Sedan	2000 ->		
Getz 1.4 i	2005 ->		
Getz 1.6	2002 ->		
Matrix 1.6	2001 ->		

Ref. 85396 NEW

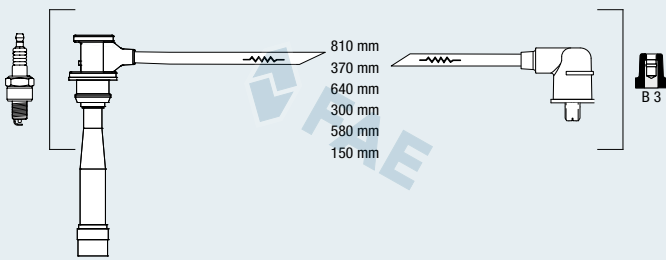

HYUNDAI			
Coupe 2.7 V6	2002 ->		
Santa Fé 2.7 V6 4x4	2001-06		
Sonata IV 2.5 V6 24V	1998-01		
Sonata IV 2.7 V6	2001-04		
Trajet 2.7 V6	2000 ->		

Ref. 85400

Supplied up to exhausting stock / Suministrado hasta agotar existencias / Fourni jusqu'a épuisement du stock

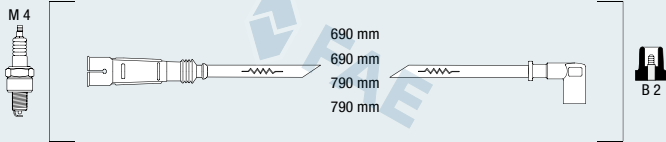

ALFA ROMEO			
33 1.7 ie 107 cv.	1988-94		
145 1.6 ie 103 cv.	1994 ->		
146 1.6 ie 103 cv.	1994 ->		

Ref. 85401

Supplied up to exhausting stock / Suministrado hasta agotar existencias / Fourni jusqu'a épuisement du stock

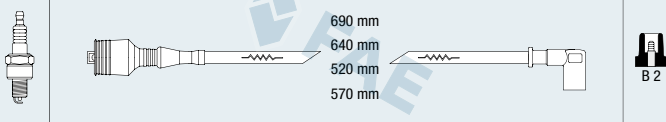

ALFA ROMEO			
Alfa 145 1.6 i	1994-96		
Alfa 146 1.6 i	1994-96		

Engines/Motores/Moteurs:
AR-33201. Nr. 0005651->.

**Ref. 85402**

Supplied up to exhausting stock / Suministrado hasta agotar existencias / Fourni jusqu'a épuisement du stock

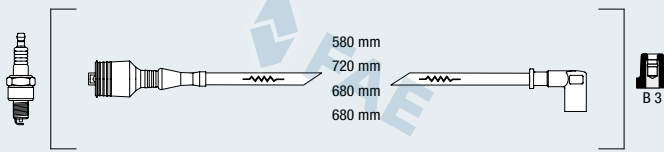

ALFA ROMEO			
Alfa 145 1.3 ie	1994-96		
Alfa 146 1.3 ie	1994-96		
Engines/Motores/Moteurs:			
AR-33501.			

Ref. 85410

Supplied up to exhausting stock / Suministrado hasta agotar existencias / Fourni jusqu'a épuisement du stock

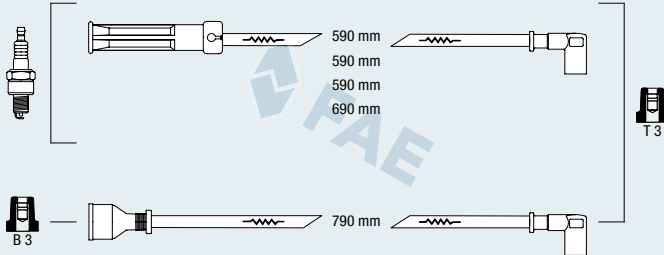

ROVER			
220 2.0 i GTI	1991-92		
220 GTI, SLI, Sport. 16V	1992-93		
420 GLI, SLI, Sport. 16V	1992-93		
820 2.0 i E, SE	1986-91		

Ref. 85420

Supplied up to exhausting stock / Suministrado hasta agotar existencias / Fourni jusqu'a épuisement du stock

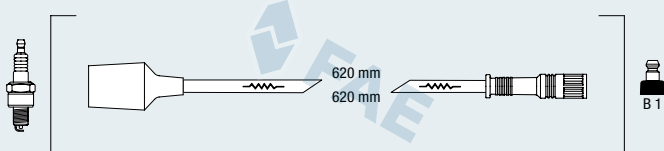

CITROËN			
2 CV (F)	1983-90		
Acadiane 2 cil.	1983-87		
Mehari 0.6	1979-87		
Mehari 4x4	1979-87		

Ref. 85430

Supplied up to exhausting stock / Suministrado hasta agotar existencias / Fourni jusqu'a épuisement du stock

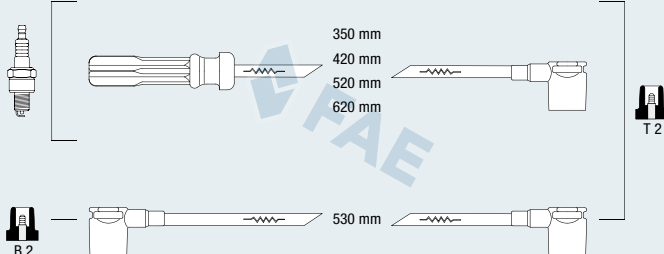

VOLVO		VOLVO Cont.	
740 2.0 (B200E, F)	1987-90	940 2.3 i Turbo (B230FT)	1990-94
740 2.0 i Turbo (B200ET)	1987-90	960 2.0 i (B200E, F)	1990-93
740 2.3 (B230K)	1987-90	960 2.0 i Turbo (B200FT)	1990-93
740 2.3 i (B230E, F)	1987-90	960 2.3 i (B230E, F)	1990 ->
740 2.3 i Turbo (B230ET,FT)	1987-90	960 2.3 i Turbo (B230FT,GT)	1990 ->
760 2.3 i Turbo (B230ET,FT)	1985-91		
780 2.0 i (B200ET)	1985-91		
940 2.0 i (B200E, F)	1990-94		
940 2.0 i Turbo (B200FT)	1990-98		
940 2.3 i (B230E, F)	1990-94		

Ref. 85440

Supplied up to exhausting stock / Suministrado hasta agotar existencias / Fourni jusqu'a épuisement du stock

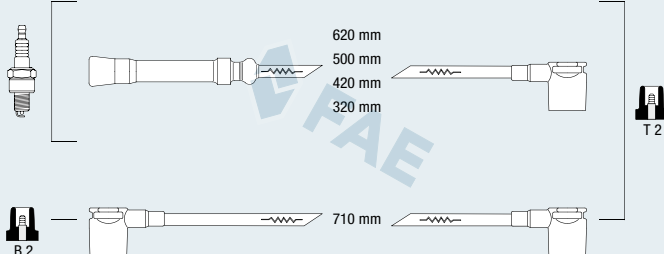

VOLVO			
740 2.0 i (B204E)	1984-90		
740 2.0 i (B204FT)	1984-90		
740 2.0 i (B204GT)	1984-90		
740 2.3 i (B234F)	1984-90		
780 2.0 i (B204GT)	1987-90		
940 2.0 i (B204E)	1990 ->		
940 2.3 i (B234F, G)	1990->		
960 2.0 i (B204E)	1990 ->		
960 2.3 i (B234F, G)	1990 ->		

Ref. 85460

Supplied up to exhausting stock / Suministrado hasta agotar existencias / Fourni jusqu'a épuisement du stock

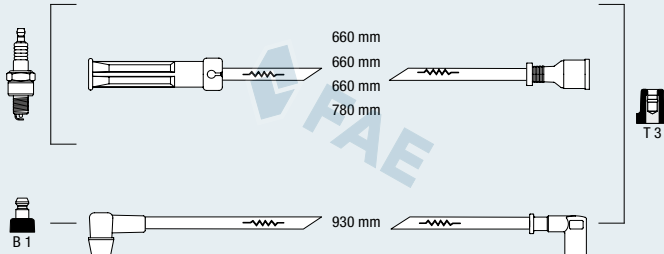

VOLVO			
240 2.3 i GL, GLT	1988-90		
340. 343. 345. 2.0 (B19A)	1980-85		
360 2.0 (B19A, E)	1980-85		
360 2.0 (B200A)	1985-87		
360 2.0 GL, GLT, GLE. (B200K)	1986-89		
360 2.0 i (B200E, F)	1986-89		
360 2.0 i Ch.360101 ->	1986-89		
740 2.3	1983-90		



Ref. 85470

Supplied up to exhausting stock / Suministrado hasta agotar existencias / Fourni jusqu'a épuisement du stock

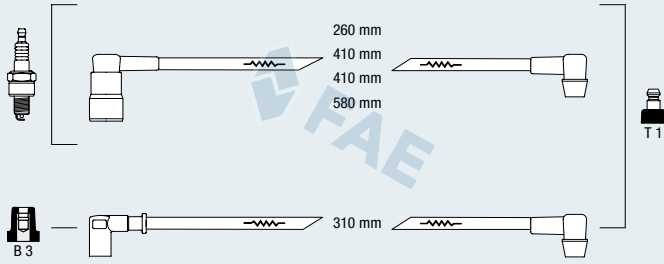

VOLVO			
440 1.7 i Turbo (B18FT)	1988-96		
440 1.7 i Turbo (B18FTM)	1988-96		
460 1.7 i Turbo (B18FT)	1990-96		
460 1.7 i Turbo (B18FTM)	1990-96		
480 1.7 i Turbo (B18FT)	1986-96		
480 2.0 Turbo	1993-95		

Ref. 85480

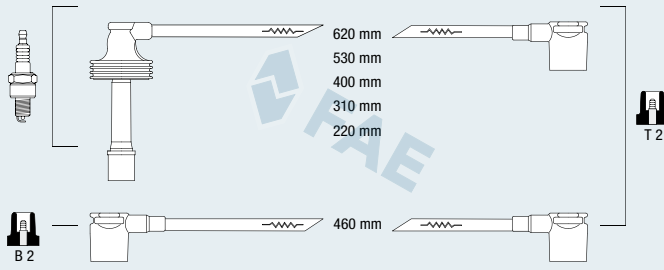

VOLVO			VOLVO Cont.
850 2.0 i GLE, GLT	1991-96	V 70 2.4 i GLE, GLT	1997-00
850 2.0 i Turbo (B5204FT)	1991-96		
850 2.3 i Turbo (B5234FT)	1994-96		
850 2.4 i GLE, GLT	1991 ->		
S40 I 2.0	1995-03		
S 70 2.0 i 20V (B5204FS)	1997-00		
S 70 2.3 i Turbo	1997-00		
S 70 2.4 i GLE, GLT	1997 ->		
V 70 2.0 i 20V (B5204FS)	1997-00		
V 70 2.3 i Turbo	1997-00		

Ref. 85481

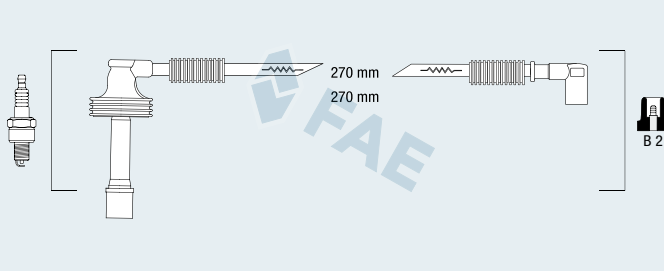

VOLVO			
S40 1.6 i, 1.8 i	1999-03		
S40 1.8 i 16V	1999-03		
S40 1.9 i T4	1997-00		
S40 2.0 i 16V	1999-03		
S40 2.0 i T	1997-03		
V40 1.6 i, 1.8 i 16V	1999-04		
V40 1.9 i T4	1997-00		
V40 2.0 i 16V	1999-04		
V40 T 2.0 i T	1997-04		
V40 T 2.0 i T4	2000-04		

Ref. 85485

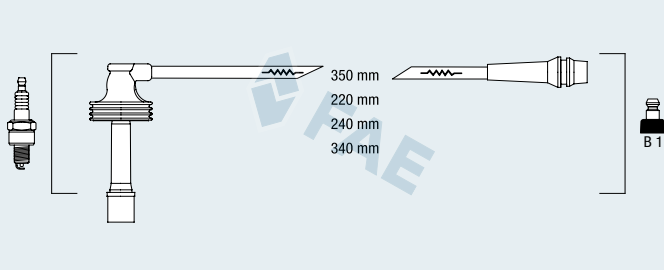

RENAULT			VOLVO Cont.
Laguna 2.0i 16V RXE,RTI	1995-01	S40 2.0i 16V (B4204S)	1996-04
Laguna GrandTour 2.0i	1995-01	S40 2.0i 16V Turbo	1996-00
Safrane 2.0i 16V RTE,RTX	1996-00	S40 2.0i T4 (B4194T)	1996-03
Engines/Motores/Moteurs:		V40 1.6i 16V (B4164S)	1997-99
N7Q.		V40 1.8i 16V (B4184S)	1996-04
VOLVO		V40 2.0i 16V (B4204)	1996-04
S40 1.6i 16V (B4164S)	1997-99	V40 2.0i 16V Turbo	1996-99
S40 1.8 (B4204S)	1996-03	V40 2.0i T4 (B4194T)	1996-04
S40 1.8i 16V (B4184S)	1996-03		

Ref. 85490

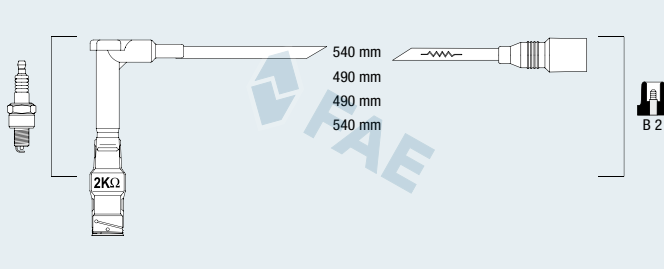

MERCEDES BENZ			
200 CE, E, TE	1993 ->		
220 CE, E, TE	1993 ->		
C 180 16V (W202)	1993-00		
C 200 16V (W202)	1993-00		
C 220 16V (W202)	1993 ->		
E 200 16V (W124)	1992 ->		
E 220 16V (W124)	1992 ->		
Engines/Motores/Moteurs:			
M 111.			

Ref. 85500

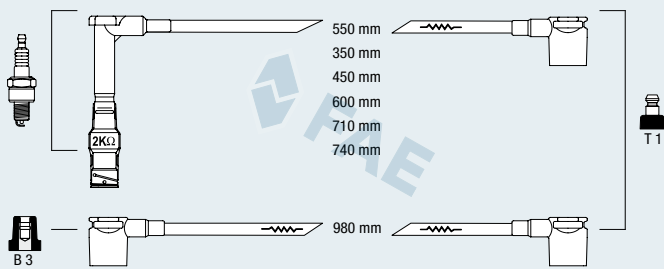

MERCEDES BENZ			
300 3.0 SL 24V (Typ 129)	1989-92		
300 3.2 SE,SEL.(Typ 124)	1991 ->		
300 CE, E, TE. (Typ 124)	1990-93		
320 3.2 S (Typ 140)	1992 ->		
Engines/Motores/Moteurs:			
M 104.			

**Ref. 85620**

Supplied up to exhausting stock / Suministrado hasta agotar existencias / Fourni jusqu'a épuisement du stock

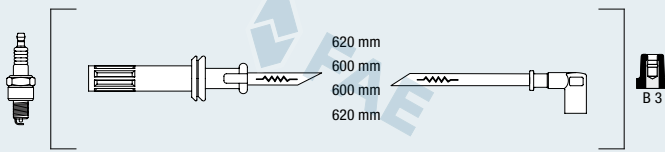

FIAT		LANCIA	
Coupe 2.0 i Turbo 16V	1994-96	Delta 2.0 i 16V HF Turbo	1993-96
		Delta HPE 2.0 ie 16V	1996 ->
		Thema 2.0 i 16V	1988-92
		Thema 2.0 i Turbo 16V	1988-92

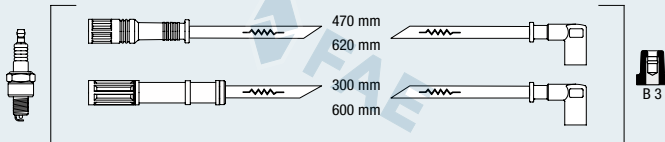
Ref. 85625

FIAT		FIAT Cont.	
Cinquecento 1.1	1994-98	Siena 1.2 i	2002 ->
Doblo 1.2, Cargo	2001 ->	Strada 1.2 i	2001 ->
Palio 1.2 i	2001 ->		
Panda 1.1 i	2003 ->	LANCIA	
Panda 1.2 i	2003 ->	Y 1.2 i	2000 ->
Panda 1100 i.e., 4x4	2000 ->	Ypsilon 1.2	2003 ->
Punto 1.2 i, Van	2003 ->		
Punto 1.2 i 60	1999 ->		
Punto Van 1.2 i 60	2000 ->		
Seicento 1.1 i	1998 ->		

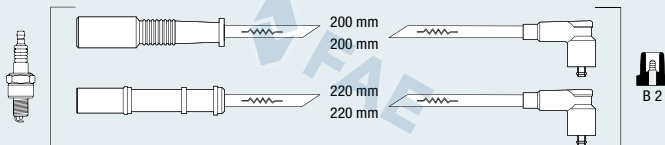
Ref. 85626 NEW

FIAT		LANCIA	
500 1.2 LPG	2010 ->	Musa 1.4	2005 ->
500 C 1.2	2009 ->	Musa 1.4 LPG	2010 ->
Doblo 1.4	2005 ->	Ypsilon 1.2	2011 ->
Doblo 1.4 Cargo	2005 ->	Ypsilon 1.4 LPG	2010 ->
Grande Punto 1.2	2005 ->		
Grande Punto 1.4	2005 ->		
Idea 1.4, LPG	2005 ->		
Linea 1.4	2007 ->		
Punto Evo 1.2	2009-12		
Punto Evo 1.4	2009-12		

Ref. 85630

Supplied up to exhausting stock / Suministrado hasta agotar existencias / Fourni jusqu'a épuisement du stock

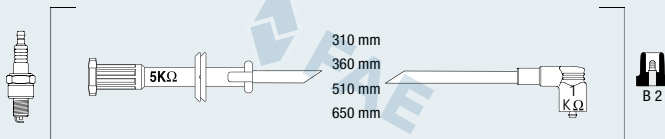

FIAT		LANCIA	
Croma 2.0 i 16V	1991-96	Kappa 2.0 i 16V Turbo	1995-98
		Thema 2.0 i 16V	1992-94
		Thema 2.0 i 16V Turbo	1992-94

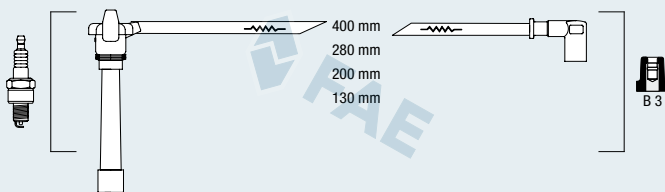
Ref. 85647

FIAT		LANCIA	
Brava 1.2 16V	1998-00	Y 1.2 i 16V	1996-03
Bravo 1.2 16V	1998-00	Ypsilon 1.2	2003 ->
Doblo 1.2	2001 ->		
Marea 1.2 16V	1998 ->		
Palio 1.2 i 16V	1996 ->		
Panda 1.2 4x4	2004 ->		
Punto 85 1.2 i 16V	1996-99		
Punto Cabrio 1.2 i 16V	1998 ->		
Siena 1.2	1998 ->		
Strada 1.2	2003 ->		

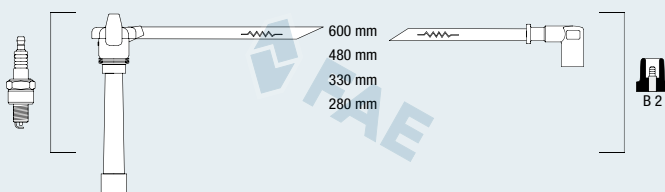
Ref. 85648

FIAT		LANCIA	
Brava 80 1.2 i 16V	1998-01	Y 1.2 16V	2000-03
Bravo 1.2 SX	1998-01	Ypsilon 1.2	2003 ->
Marea 80 1.2 i 16V	1999 ->		
Palio 1.2	1996 ->		
Punto 1.2 i 16V	1999 ->		
Strada 1.2	2003 ->		



Ref. 85650

Supplied up to exhausting stock / Suministrado hasta agotar existencias / Fourni jusqu'a épuisement du stock

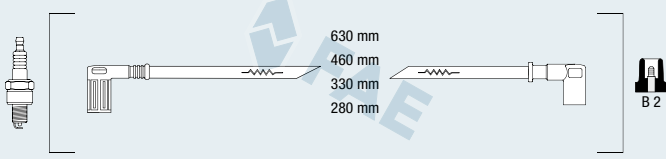

FIAT		LANCIA	
Punto 90 1.6 i MPI-GM	1994-96	Dedra 1.6 LE, SW	1994-99
Punto Cabrio 90 ELX	1994-97	Dedra 1.8 i.e.	1989-99
Tempra 1.6 i MPI-GM	1993-96	Dedra 1.8 i.e., SW	1994-99

Ref. 85680

Supplied up to exhausting stock / Suministrado hasta agotar existencias / Fourni jusqu'a épuisement du stock

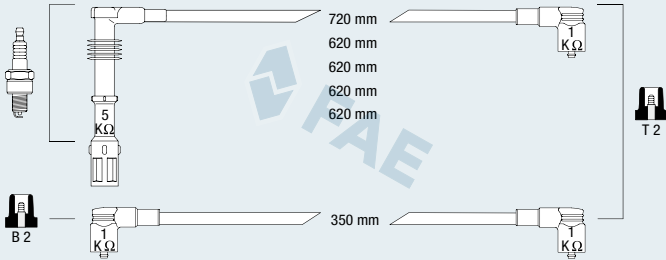

AUDI			
80 2.0 E 20V (NM)	1988-91		
80 2.3 E, Quattro. (7A)	1988-91		
90 2.0 E 20V (NM)	1988-91		
90 2.3 E, Quattro. (7A)	1988-91		
Coupe 2.0 E 20V (NM)	1989-91		
Coupe 2.3 E, Quattro. (7A)	1989-91		

Ref. 85681

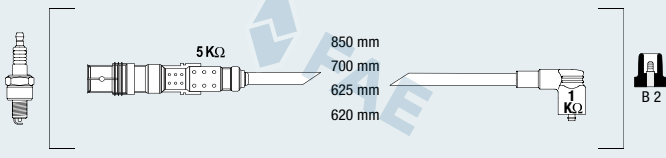

SEAT		VOLKSWAGEN	
Arosa 1.0 i, 1.4 i	1997-04	Caddy II 60 1.4	1995-04
Cordoba 1.0 Fastback	1999-02	Lupo 1.0	1998-05
Cordoba 1.4, Fastback, Vario	1999-02	Lupo 1.4	2000-05
Ibiza III 1.0 i, 1.4 i	1999-02	Lupo 1.4 FSI	2001-05
Inca 1.4 i	1995 ->	Lupo 1.6 GTI	2000-05
SKODA		Polo 1.0	1999-01
Fabia 1.0, 1.4	1999 ->	Polo 1.4	1999-01
Octavia 1.4	1999 ->	Polo 1.4 Variant	1997-01
		Polo 1.4, Variant	1998-01
		Polo 60 1.4 Classic	1995-01

Ref. 85682

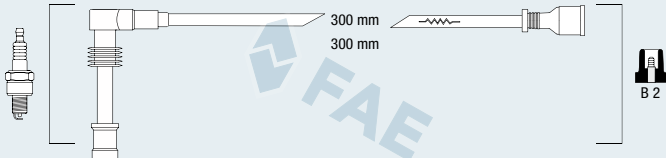

AUDI		SKODA	
A3 1.8, Quattro	1996 ->	Octavia 1.8 20V	1996 ->
A4 1.8 i	1995-00	VOLKSWAGEN	
A4 1.8 i Quattro	1995-00	Bora 1.8 4Motion	1999-05
A4 Avant 1.8 i Quattro	1995-01	Golf IV 1.8 4Motion	1997 ->
A6 1.8 i, Avant	1997 ->	Passat 1.8 i	1996-00
A6 Avant 1.8 i Quattro	1995-97	Passat Variant 1.8 i	1997-00
SEAT			
Leon 1.8 20V	1999 ->		
Toledo 1.8 20V	1999-06		

Ref. 85685

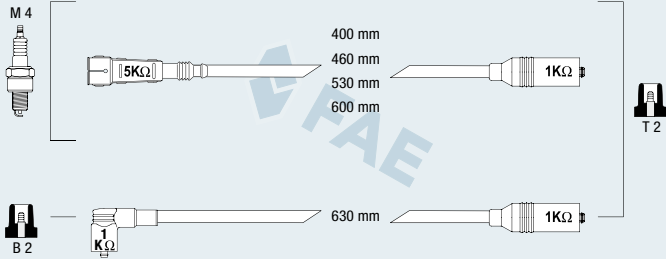

VOLKSWAGEN Cont.			
Jetta II 1.8 Kat	1987-91		
Jetta II 1.8 Syncro	1987-88		
Passat 1.6, Variant	1980-88		
Passat 1.8 G60 Syncro, Variant	1988-96		
Passat 1.8, Syncro, Variant	1996-00		
Passat 1.8, Variant	1983-88		
Passat 2.0 4motion	2000-00		
Passat 2.0, 4motion, Variant	1995-96		
Passat 2.0, Syncro, Variant	1990-96		
Santana 1.8	1983-84		
Scirocco 1.6	1986-90		
Sharan 2.0	1995-10		
Vento 1.8	1991-98		
Vento 2.0	1991-98		

SEAT		VOLKSWAGEN	
Cordoba 1.8 i	1993-99	Corrado 2.0 i	1993-95
Cordoba 2.0 i	1993-99	Golf I 1.6 Cabrio	1986-90
Ibiza II 1.0	1993-96	Golf II 1.8 GTI	1985-87
Ibiza II 1.8 i	1993-99	Golf II 1.8 GTI Kat	1987-91
Ibiza II 2.0 i	1993-99	Golf III 1.8	1991-97
Toledo I 1.8 i	1993-96	Golf III 1.8 Syncro Variant	1994-99
Toledo I 2.0 i	1991-99	Golf III 1.8 Variant	1993-99
		Golf III 1.8, Cabrio, Syncro	1993-98
		Golf III 2.0 Syncro, Variant	1995-97
		Golf III 2.0, Cabrio, Variant	1991-97
		Jetta II 1.6	1984-92
		Jetta II 1.8	1985-87



Ref. 85690

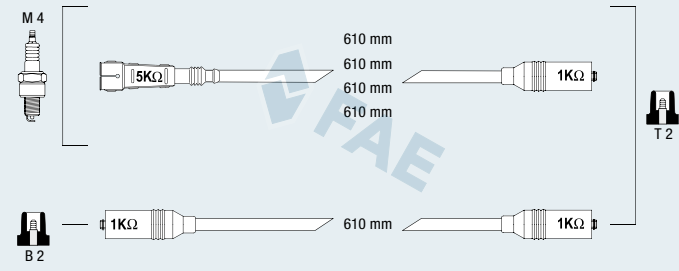

VOLKSWAGEN Cont.		VOLKSWAGEN Cont.	
Golf II 1.0	1983-85	Vento 1.4	1991-98
Golf II 1.6	1983-92	Vento 2.0	1991-98
Golf II 1.8	1984-91		
Golf II 1.8 GTI	1983-91		
Golf II 1.8 GTI G60 Syncro	1988-91		
Golf II 1.8 i Kat	1987-91		
Golf II 1.8 i Syncro Kat	1987-91		
Golf II 1.8 Syncro	1986-91		
Golf III 1.8	1991-97		
Golf III 1.8 Variant	1993-99		
Golf III 2.0, Cabrio, Variant	1991-97		
Golf IV 1.8 Cabrio	1998-02		
Golf IV 2.0 Cabrio	1998-02		
Jetta II 1.8	1984-91		
Jetta II 1.8 Kat	1987-91		
Passat 1.6, Variant	1988-91		
Passat 1.8, Variant	1988-96		
Passat 2.0, Syncro, Variant	1990-96		
Passat 2.0, Variant	1995-96		
Polo 75 1.6 Classic	1995-01		
Scirocco 1.6	1983-84		
Scirocco 1.8	1982-89		
Transporter IV 1.8	1990-92		
Transporter IV 2.0	1990-03		

AUDI		SEAT Cont.	
100 2.0 E Quattro, Avant	1990-92	Toledo I 1.8 i	1991-96
100 2.0 E, Avant	1991-94	Toledo I 2.0 i	1991-99
A6 2.0, Avant	1994-97	VOLKSWAGEN	
SEAT		Caddy I 1.5	1982-83
Cordoba 1.6 i, Vario	1994-99	Caddy I 1.6	1983-92
Cordoba 1.8 i	1993-99	Caddy I 1.8	1985-92
Cordoba 2.0 i	1993-99	Caddy II 1.6	1995-97
Ibiza II 1.6 i	1994-99	Caddy II 75 1.6	1995-97
Ibiza II 1.8 i	1993-99	Corrado 1.8 G60	1988-93
Ibiza II 2.0 i	1993-99	Corrado 2.0 i	1993-95
Toledo I 1.6 i	1991-93	Golf I 1.6 Cabrio	1983-92
Toledo I 1.8 16V	1991-99	Golf I 1.8 Cabrio	1982-89

Ref. 85691

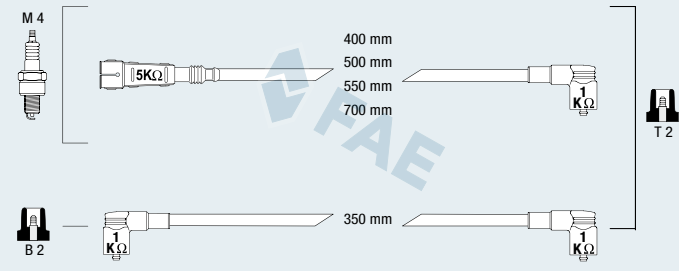

SEAT		SKODA	
Arosa 1.0 i (AER)	1997 ->	Felicia 1.6 Combi	1995 ->
Arosa 1.4 i (AEX)	1997 ->	Octavia 1.6 i (75 cv.)	1997 ->
Ibiza 1.0 i (AER)	1997 ->	VOLKSWAGEN	
		Lupo 1.0	1998-05
		Polo 1.0, 1.4, 1.6	1994-99
		Polo XXL 1.0 (AER)	1996 ->

Ref. 85692

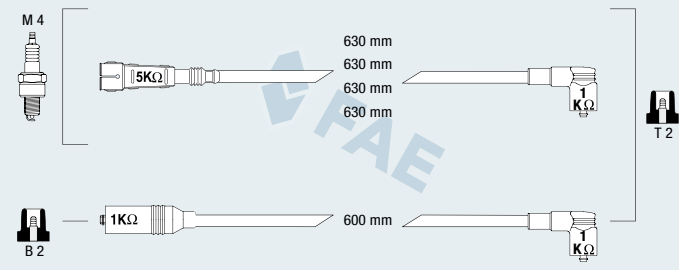

VOLKSWAGEN Cont.			
Polo 1.4 Variant	1997-01		
Polo 1.6 Variant	1997-01		
Polo 100 1.6 Classic	1995-01		
Polo 60 1.4	1995-99		
Polo 60 1.4 Classic	1995-01		
Polo 75 1.6	1994-99		
Polo 75 1.6 Classic	1995-01		
Vento 1.4	1991-98		
Vento 1.6	1994-98		

SEAT		SKODA	
Cordoba 1.4 i Vario	1996-99	Felicia 1.6 GLX Kombi	1995-98
Cordoba 1.6 i, Vario	1994-99	Felicia 1.6 LX	1995-98
Ibiza II 1.6 i	1994-99	VOLKSWAGEN	
Inca 1.6 i	1995-98	Caddy II 1.4	1995-04
Toledo I 1.6 i	1991-93	Caddy II 1.6	1995-97
Toledo I 1.8 16V	1991-99	Caddy II 60 1.4	1995-04
Toledo I 1.8 i	1993-96	Caddy II 75 1.6	1995-97
Toledo I 1.9 D	1991-99	Golf III 1.4 Variant	1993-99
Toledo I 1.9 TD	1991-99	Golf III 1.6, Cabrio, Variant	1994-98
Toledo I 1.9 TDI	1995-99	Golf III 1.6, Variant	1992-97
Toledo I 2.0 i	1991-99	Passat 1.6, Variant	1994-95
Toledo I 2.0 i 16V	1993-99	Polo 1.4 Furgón	1998-99

Ref. 85693

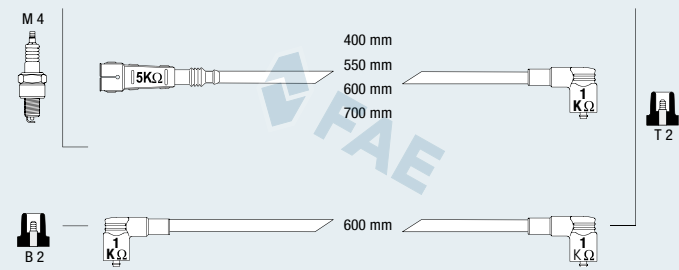

SEAT		VOLKSWAGEN	
Cordoba 1.6 i (AEE)	1996-02	Caddy 60 1.4 i (AEX)	1996 ->
Ibiza 1.4 i (AEX)	1996-02	Golf III 1.4 i (AEX)	1995-96
Inca 1.4 MPI (AEX)	1996 ->	Golf III 1.6 i (AEE)	1995-96
Inca 1.6 MPI (AEE)	1996 ->	Polo 60 1.4 i (AEX)	1995-01
SKODA		Polo Classic 1.4, 1.6	1995-01
Octavia 1.6	1996 ->	Vento 1.4 i (AEX)	1995-96
		Vento 1.6 i (AEE, AEA)	1994-96



Ref. 85694

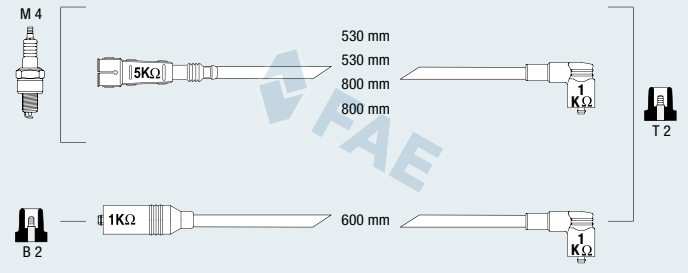

SEAT		VOLKSWAGEN	
Cordoba 1.4 i GLX, Vario	1993-96	Golf III 1.4 i, Variant	1991-95
Ibiza 1.4 i (60 cv., ABD)	1993-96	Transporter Type 2 1.9	1984-92
Ibiza 1.6 i (ABU)	1994-96	Transporter Type 2 2.1	1985-92
Inca 1.4 i (ABD)	1995 ->	Vento 1.4 i CL, GL. (ABD)	1994-97
SKODA		Vento 1.6 i (ABU)	1994-97
Felicia 1.6, 1.6 LX	1995 ->		

Ref. 85695

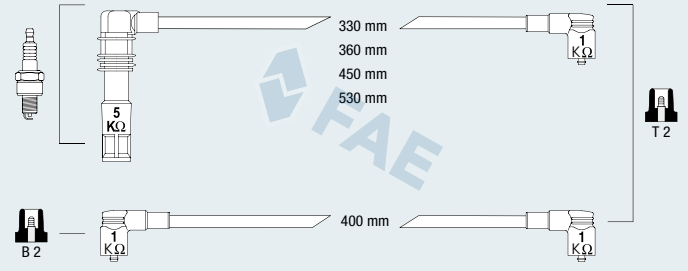

SEAT		VOLKSWAGEN	
Ibiza 1.0 16V (AST) (Brasil)	1999 ->	Polo XXL 1.4 16V (AFH)	1996-99
Ibiza 1.4 16V (AFH)	1996-99		
Cordoba 1.0 16V (AST, AFR)	1999 ->		
Cordoba 1.4 16V (AFH)	1996-99		

Ref. 85696

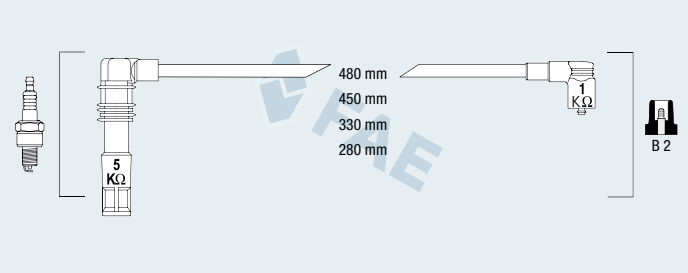

VOLKSWAGEN Cont.			
Polo 1.6 16V GTI	1999-01		
Polo 120 1.6 16V GTI	1998-99		
Polo 75 1.4 16V Classic	1999-01		

AUDI		VOLKSWAGEN	
A 2 1.4 i 16V	2000-05	Bora 1.4 16V	2000-05
SEAT		Bora 1.4 16V Kombi	2001-05
Arosa 1.4 i 16V	1998-04	Bora 1.6 16V, Kombi	2000-05
Cordoba 1.4 i 16V, SX	1999 ->	Caddy II 1.4 16V	2000-04
Cordoba Vario 1.4 i 16V	1999 ->	Golf IV 1.4 16V	1997-05
Ibiza 1.4 i 16V	1999 ->	Golf IV 1.4 16V, Variant	1999-06
Inca 1.4i 16V	2000 ->	Golf IV 1.6 16V, Variant	2000-05
Leon 1.4 i 16V	1999 ->	Golf IV 2.0 Cabrio	1998-02
Toledo 1.4 i 16V	1998-06	Golf V 1.4 16V	2003-06
SKODA		Lupo 1.4 16V	1998-05
Fabia 1.4 16V	1999 ->	Polo 1.4 16V	1999-01
Octavia 1.4 16V, Kombi	2000 ->	Polo 1.4 16V Variant	1999-01

Ref. 85700

Supplied up to exhausting stock / Suministrado hasta agotar existencias / Fourni jusqu'a épuisement du stock

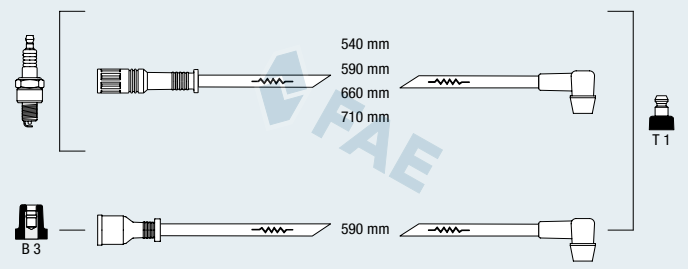

FORD			
Granada 2.0 i EFI (OHC)	1985-87		
P 100 2.0 i EFI (OHC)	1985-87		
P 100 2.0 i Cat.	1985-87		
Scorpio 2.0 i EFI (OHC)	1985-87		
Sierra 1.8 (CVH)	1988-89		
Sierra 2.0 (CVH)	1982-89		
Sierra 2.0 i EFI (OHC)	1985-87		
Transit 2.0 i EFI (OHC)	1985-87		
Transit 2.0 i Cat.	1985-87		

Ref. 85710

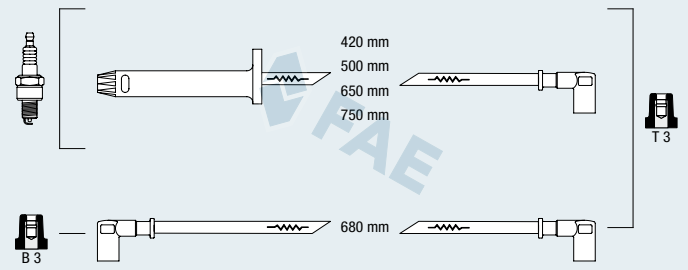

FORD			
Escort 2.0	1989 ->		
Escort 2.0 i EFI	1989 ->		
Granada MKIII 2.0	1989-93		
Granada 2.0 i EFI	1989-93		
Scorpio MKIV 2.0	1989-93		
Scorpio 2.0 i EFI	1989-94		
Sierra 2.0, 2.0 i EFI	1989-93		
Engines/Motores/Moteurs:			
DOHC / DL.			

**Ref. 85720**

Supplied up to exhausting stock / Suministrado hasta agotar existencias / Fourni jusqu'a épuisement du stock

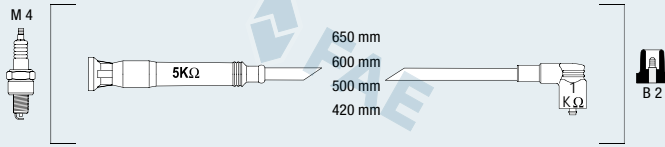

ALFA ROMEO		
155 1.75 i Twin Spark	1992 ->	Complete set consist of 8 ignition leads. Purchase of two sets needed. El juego completo está compuesto por 8 cables. Comprar 2 cajas. Le jeu complet est composé par 8 fils de bougie. L'achat de deux jeux est nécessaire.
155 1.8 i Twin Spark	1992 ->	
155 2.0 i Twin Spark	1992 ->	

Ref. 85725

Supplied up to exhausting stock / Suministrado hasta agotar existencias / Fourni jusqu'a épuisement du stock

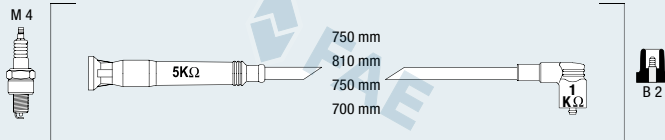

ALFA ROMEO		
Alfa 145 1.7 i 16V	1994 ->	
Alfa 146 1.7 i 16V	1994 ->	
Engines/Motores/Moteurs:		
AR-33401.		

Ref. 85730

Supplied up to exhausting stock / Suministrado hasta agotar existencias / Fourni jusqu'a épuisement du stock

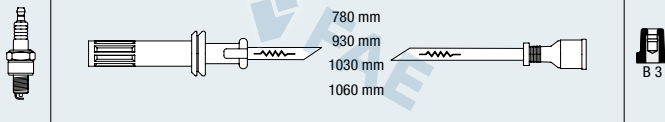

ALFA ROMEO		
155 2.0 i 16V Turbo	1992-95	
155 2.0 i Turbo Q4	1992-95	

Ref. 85739

Supplied up to exhausting stock / Suministrado hasta agotar existencias / Fourni jusqu'a épuisement du stock

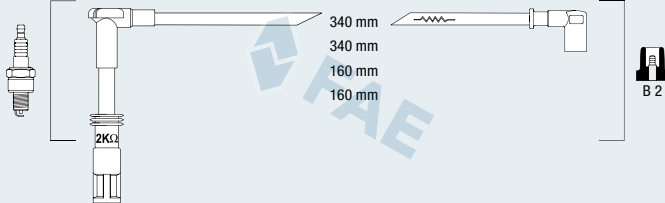

ALFA ROMEO		ALFA ROMEO Cont.	
145 1.4 i.e. 16V T.S.	1996-01	147 1.6 i, 2.0 i T.S.	2001 ->
145 1.6 i 16V T.S.	1999-01	155 1.6 i 16V T.S.	1996-98
145 1.8 i.e 16V	1998-01	155 1.7 i, 2.0 i 16V, T.S.	1995-97
145 1.8 i.e, 16V T.S	1996-99	156 1.6 i 16V T.S, S.W.	1997-05
145 2.0 i 16V, T.S, Q.V	1995-01	156 1.8 i 16V T.S, S.W.	2000-06
146 1.4 i.e, 16V T.S.	1996-01	156 2.0 i 16V T.S, S.W.	2000-02
146 1.4 i 16V T.S.	1999-01	166 2.0 i T.S.	2000 ->
146 1.8 i.e. 16V T.S.	1996-01	GTV 2.0 i 16V T.S.	2000 ->
146 2.0 i 16V Q.V.	1998-01	Spider 2.0 i 16V T.S.	1995-05
146 2.0 i 16V T.S.	1995-01		

Ref. 85740

Supplied up to exhausting stock / Suministrado hasta agotar existencias / Fourni jusqu'a épuisement du stock

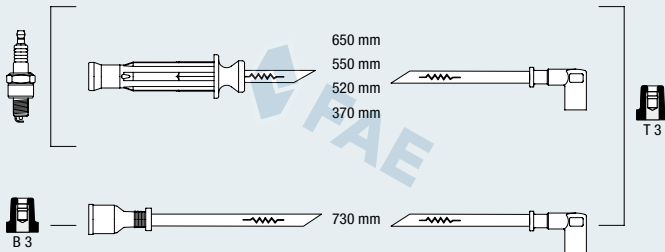

ROVER		
200 Coupe, Fastback	1991-99	
220 2.0 i 16V	1992-99	
220 Coupe 16V	1992-99	
420 2.0 i 16V	1992-99	
420 Coupe 16V	1992-99	
800 Sport, Fastback	1992-99	
820 2.0 i 16V Turbo	1992-99	
820 2.0 i 16V	1992-99	
820 2.0 i 16V SI	1992-99	

Ref. 85760

Supplied up to exhausting stock / Suministrado hasta agotar existencias / Fourni jusqu'a épuisement du stock

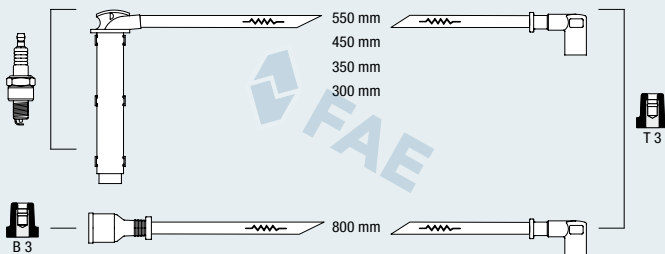

ROVER		
100 GSI / GTI 16V	1990-98	
114 GTI 16V	1990-98	
200 Fastback	1989-95	
214 1.4 i 16V	1989-95	
400 GSI / SI	1990-95	
414 1.4 i 16V	1990-95	
Metro 1.4 GTI 16V	1990-98	
Engines/Motores/Moteurs:		
K 16.		



Ref. 85764

Supplied up to exhausting stock / Suministrado hasta agotar existencias / Fourni jusqu'a épuisement du stock

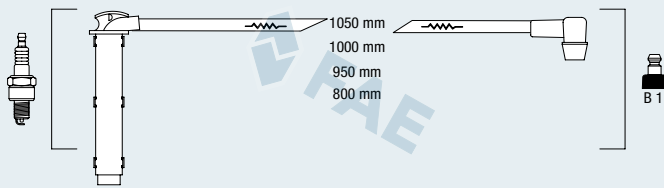

LOTUS		ROVER	
Elise 1.8i 16V	1995-00	200 218 i	1995-00
MG		200 Coupe 218	1996-00
MG ZR 160	2001 ->	25 1.8 i 16V	2000 ->
MGF 1.8 i	1995-02	400 Tourer 1.8 i	1996-98
MGTF 160	2002 ->	Coupe 1.8 i 16V	1996-99

Ref. 85765

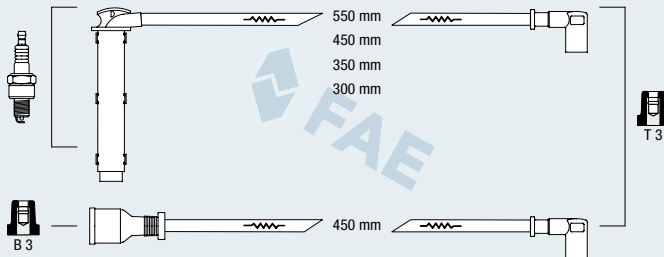

LAND ROVER		ROVER	
Freelander 1.8 16V	2000 ->	200 214, 216, Si, Coupe	1995-00
Freelander 1.8 i 16V, Soft Top	1998 ->	25 1.4 i, 1.6 i, 1.8 i, 16V	1999 ->
Freelander 2.5 V6	2000 ->	400 414, 416, Si	1995-00
MG		400 Tourer 1.6 i	1994-98
MG ZR 105	2001 ->	Cabriolet 216 1.6 i 16V	1996-99
MG ZR 120	2001 ->	Coupe 1.6 i 16V	1996-99
MGF 1.8 i 16V	1995-02		
MGTF 115, 120, 135	2002 ->		

Ref. 85766 NEW

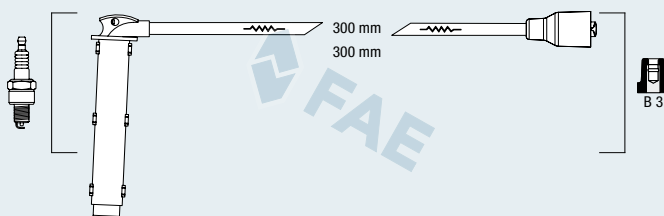

LAND ROVER		ROVER	
Freelander 2 2.0	2011 ->	25 1.4 16V	1999 ->
MG		25 1.6 16V	1999 ->
MG TF 120, 135	2002 ->	25 1.8 16V	1999 ->
MG ZR 105, 120, 160	2001 ->	45 1.4	2000 ->
MG ZS 120	2001 ->	45 1.6, Sedan	2000 ->
MG ZS 180, Fastback	2001 ->	45 1.8, Sedan	2000 ->
MG ZT 1.8 16V	2003 ->	75 1.8, Tourer, Turbo	1999 ->
MG ZT-T 1.8 T 16V	2003 ->	214 Si	1995-00
MGF 1.6	2000-02	216 Si	1995-00
MGF 1.8 i 16V	1995-02	218 K Vi	1995-00

Ref. 85780

Supplied up to exhausting stock / Suministrado hasta agotar existencias / Fourni jusqu'a épuisement du stock

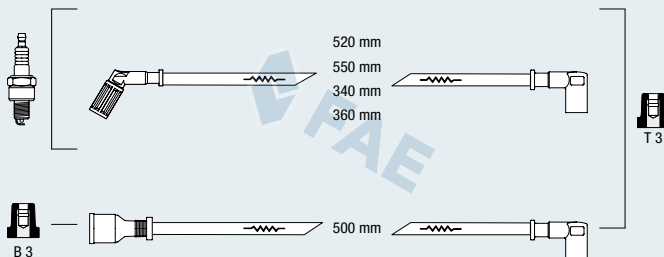

LANCIA		AUSTIN ROVER	
Y 10 1.3 i	1985-88	Metro 1.1 i	1990 ->
Y 10 1.3i GT MPI	1989-92	Metro 1.4 i	1990 ->
Y 10 1.3i Elite MPI	1992-95	ROVER	
		111 i, Si, GSi	1990 ->
		114 i, GTI	1990 ->

Ref. 85790

Supplied up to exhausting stock / Suministrado hasta agotar existencias / Fourni jusqu'a épuisement du stock

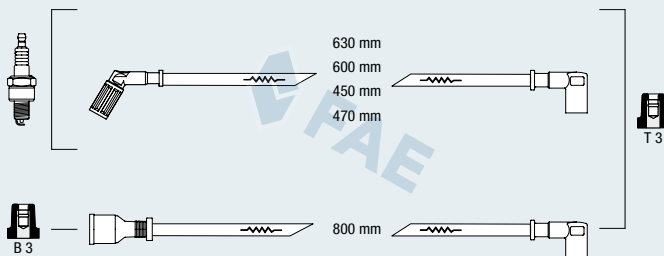

ROVER			
214 1.4, 1.4 i. ->256311	1990-92		
214 1.4 i	1992-95		
414 1.4, 1.4 i. ->256311	1990-92		
414 Si, SLI, GSi. 95 cv.	1990 ->		

Ref. 85800

Supplied up to exhausting stock / Suministrado hasta agotar existencias / Fourni jusqu'a épuisement du stock

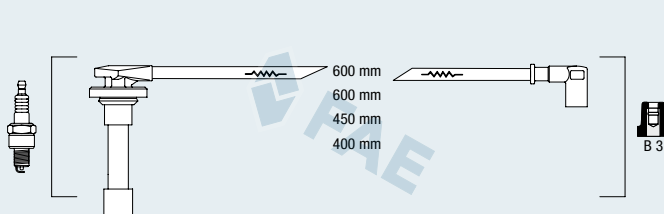

HONDA		ROVER	
Civic IV 1.5 i 16V	1991-95	216 1.6i Cabrio	1992-99
Civic IV 1.5 i 16V, Sedan	1987-91	400 1.6 i Tourer	1994-98
Civic IV 1.6 i 16V	1987-91	414 GSi/Si Kat	1993-95
Civic V 1.5 i 16V, Sedan	1991-95	416 GSi	1990-95
Civic V 1.5 i LSi Coupe	1994-95	416 GSi/GSE	1990-95
Civic VI 1.5 i Vtec-E	1994-97	416 GTI	1990-95
Concerto 1.5 i 16V, Sedan	1989-95	416 GTI/GTE	1990-95
Concerto 1.6 16V, Sedan	1989-95		
Concerto 1.6 i 16V	1989-95		
CRX II 1.6 i 16V	1987-89		

**Ref. 85801**

Supplied up to exhausting stock / Suministrado hasta agotar existencias / Fourni jusqu'a épuisement du stock

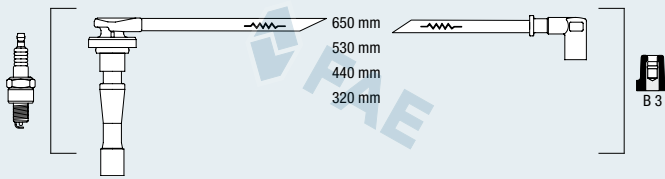

HONDA			
CR-V I 2.0 16V	1995-99		
CR-V II 2.0	2002-06		
CRX II 1.6 i 16V Vtec	1989-92		

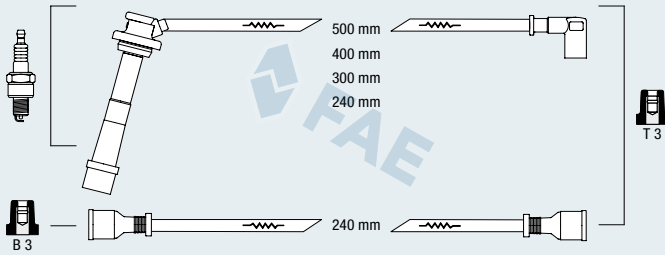
Ref. 85805

SUZUKI			
Baleno 1.3 16V Kombi	1997-02		
Baleno 1.3 i 16V, Fastback	1995-02		
Baleno 1.3, Fastback	1996-02		
Baleno 1.6 i 16V, 4x4, Fastback	1995-02		
Baleno 1.6 i 16V Kombi	1996-02		
Grand Vitara I 1.6	1998 ->		
Vitara 1.6 16V	1990-98		
Vitara 1.6 i 16V Cabrio	1990-99		
Vitara 1.6, Cabrio	1988-95		
X-90 1.6 i 16V, 4x4	1995 ->		

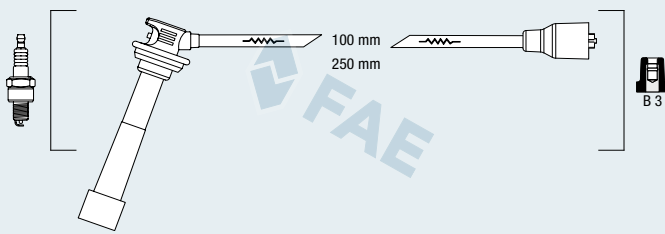
Ref. 85806 NEW

SUZUKI		SUZUKI Cont.	
Alto IV 1.1	2002 ->	Wagon R+ 1.3 4WD	2001 ->
Baleno 1.3 16V Kombi	1997-02		
Baleno 1.3 i 16V, Fastback	1995-02		
Baleno 1.6 i 16V, 4x4, Fastback	1995-02		
Baleno 1.6 i 16V Kombi	1995-02		
Carry 1.3 16V Furgón	2000 ->		
Carry 1.3 Furgón	1999 ->		
Jimny 1.3 16V	1998 ->		
Jimny 1.3 16V 4WD	1998 ->		
Wagon R+ 1.3	2000 ->		

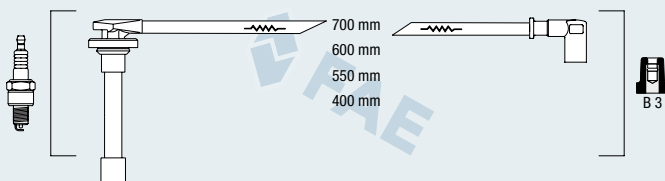
Ref. 85811

HONDA Cont.			
Civic VI 1.6 i	1994-97		
Civic VI 1.6 i Vtec Coupe	1999-00		
Civic VI 1.6 VTI, Sedan	1995-01		
Concerto 1.4, Sedan	1989-91		
Concerto 1.6 i 16V, Sedan	1989-95		
CRX III 1.6 i VTI	1992-98		
Integra 1.8 Type-R Coupe	1997-01		
Prelude IV 2.0 i 16V	1992-96		
Prelude IV 2.3 i 16V	1992-96		
Prelude V 2.0 16V	1996-00		
Shuttle 2.2 16V	1994-98		

ROVER			
216	1985-89		
216 Coupe	1992-99		
216 GSi	1989-95		
216 GTi	1990-95		
216 Vitesse	1985-89		
618 i/Si	1996-99		
620 i	1993-96		
620 Si	1993-99		
623 Si	1993-99		

HONDA		HONDA Cont.	
Accord IV 2.0 16V	1990-93	Accord V 2.3 i SR	1993-96
Accord IV 2.0 i 16V	1990-93	Accord VI 1.9 i	1996-98
Accord IV 2.0 i 16V Aerodeck	1993-93	Accord VI 2.0 i LS	1996-98
Accord IV 2.0 i 16V Coupe	1992-93	Accord VII 1.8 i	1998-02
Accord IV 2.2 i 16V	1990-93	Civic II 1.6 i 16V 4WD Shuttle	1988-95
Accord IV 2.2 i 16V Aerodeck	1991-93	Civic IV 1.3 16V	1989-91
Accord IV 2.2 i 16V Automatik	1990-93	Civic IV 1.3, Sedan	1987-89
Accord V 2.0 Coupe	1993-97	Civic IV 1.5 i 16V, Sedan	1988-91
Accord V 2.0 i	1993-96	Civic IV 1.6 i 16V	1987-91
Accord V 2.0 i LS 16V Aerodeck	1993-98	Civic IV 1.6 i 16V Sedan	1987-91
Accord V 2.0 i S	1993-96	Civic IV 1.6 i 16V, Sedan	1987-91
Accord V 2.2 i ES	1993-98	Civic V 1.3 Sedan	1992-92

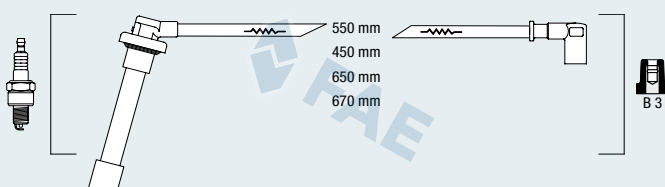
Ref. 85821

HONDA		HONDA Cont.	
Accord V 2.2 i, 16 V	1994-97	Civic 1.6i 16V EX 120 cv.	1991-97
Accord V Coupé 2.2 i	1994 ->	Civic 1.6i 16V VTEC	1991-97
Accord VI 2.2 i Vtec	1996 ->	Civic V 1.4 i 16V	1998-00
Accord VII Coupe 2.0 16 Vtec	1999 ->	Civic V 1.5 i, 1.6 i 16V	1998-01
Accord VII Coupe 2.3 16 Vtec	1998-01	Civic V 1.6 i 16V Vtec	1998-00
Civic 1.4i 16V	1995-97	CRX 1.6	1992-98
Civic 1.5i VTEC	1991-96	HR-V 1.6 16V 4WD	1999 ->
Civic 1.5i ES, LS. 90 cv.	1991-96	HR-V 1.6 16V, 4WD	1999 ->
Civic 1.6i VTEC	1991-96	Logo 1.3 i	1999 ->
Civic 1.6i ES, LS. 90 cv.	1991-96	Shuttle 2.2 16V	1994-02



Ref. 85865

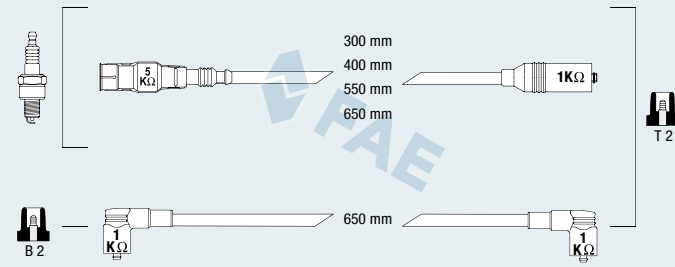

VOLKSWAGEN Cont.			
Golf II 1.8 i Kat	1987-91		
Golf II 1.8 i Syncro Kat	1987-91		
Golf III 1.6, Cabrio, Variant	1994-98		
Golf III 1.8	1991-97		
Golf III 1.8 Variant	1993-99		
Golf III 1.8, Cabrio	1991-97		
Golf III 1.8, Cabrio, Syncro	1993-97		
Golf IV 1.6 Cabrio	1998-02		
Jetta II 1.6	1986-91		
Jetta II 1.8	1984-91		
Jetta II 1.8 Kat	1987-91		
Passat 1.6, Variant	1988-91		
Passat 1.8, Variant	1988-96		
Passat 2.0, Syncro, Variant	1990-96		
Polo 1.6 Variant	1997-01		
Polo 100 1.6 Classic	1995-01		
Scirocco 1.6	1983-84		
Scirocco 1.8	1982-89		
Sharan 2.0	1995-10		
Vento 1.6	1994-98		
Vento 1.8	1991-98		
Vento 2.0	1991-98		
Engines/Motores/Moteurs:			
AFT 100 cv.			

SEAT	
Alhambra 2.0 i	1996-10
Cordoba 1.6 i, Vario	1996-99
Ibiza II 1.6 i	1996-99
Toledo I 1.6 i	1991-99
Toledo I 1.8 16V	1991-99
Toledo I 1.8 i	1991-96
Toledo I 2.0 i	1991-99
SKODA	
Felicia 1.3 i Kombi	1995 ->

VOLKSWAGEN	
Caddy I 1.5	1982-83
Caddy I 1.6	1983-92
Caddy I 1.8	1985-92
Corrado 1.8 G60	1988-93
Corrado 2.0 i	1993-95
Golf I 1.6 Cabrio	1983-92
Golf I 1.8 Cabrio	1982-89
Golf II 1.0	1983-85
Golf II 1.6	1983-92
Golf II 1.8	1984-91
Golf II 1.8 GTI	1983-91
Golf II 1.8 GTI G60 Syncro	1988-91

Ref. 85870

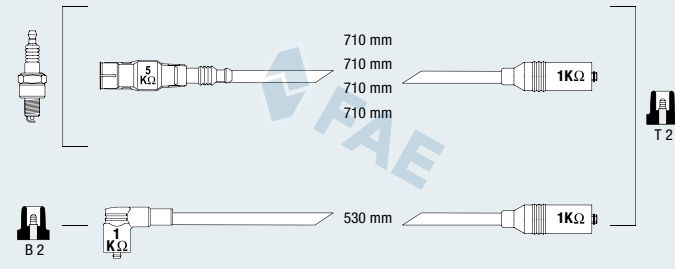

AUDI		VOLKSWAGEN	
A4 1.6 i (ADP)	1995-00	Golf III 1.6	1994-99
A4 Avant 1.6	1996-00	Golf III Cabrio 1.6	1995-99
		Golf III Variant 1.6	1994-99
		Passat 1.6	1994-00
		Passat Variant 1.6	1995-00
		Vento 1.6	1994-98

Ref. 85871 NEW

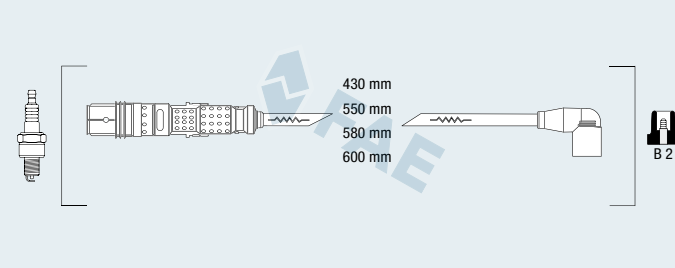

AUDI		SKODA	
A1 1.2 TFSI, Sportback	2010 ->	Octavia 1.2 TSI	2010 ->
A3 1.2 TSI, Cabrio, Sportback	2010 ->	Octavia 1.2 TSI Combi	2010 ->
SEAT		VOLKSWAGEN	
Altea 1.2 TSI	2010 ->	Roomster 1.2 TSI	2010 ->
Altea XL 1.2 TSI	2010 ->	Yeti 1.2 TSI	2009 ->
Ibiza V 1.2 TSI	2010 ->	Caddy III 1.2 TSI	2010 ->
Ibiza V 1.2 TSI Sportcoupe	2010 ->	Golf VI 1.2 TSI, Variant	2009 ->
Ibiza V 1.2 TSI ST	2010 ->	Polo 1.2 TSI	2009 ->
Leon 1.2 TSI	2010 ->	Touran 1.2 TSI	2010 ->

Ref. 85874 NEW

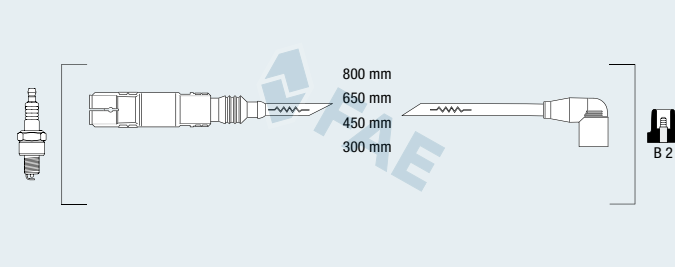

AUDI		VOLKSWAGEN	
A3 1.6	2000 ->	Bora 2.0	1998-05
Octavia 2.0 4x4 Combi	2000-04	Bora 2.0 4motion, Kombi	2000-05
		Bora 2.0 Kombi	1999-05
		Golf IV 2.0	1998-04
		Golf IV 2.0 4motion, Variant	2000-05
		Golf IV 2.0 Bi-Fuel Variant	2002-06
		Golf IV 2.0 Variant	1999-06
		New Beetle 2.0	1998 ->
		New Beetle 2.0 Cabrio	2002-10



Ref. 85875

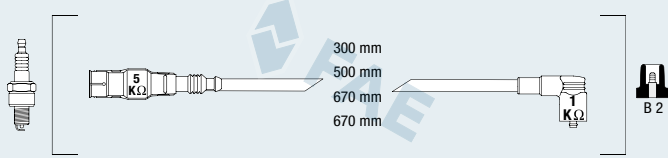

AUDI		SEAT Cont.	
A3 1.6	1996-00	Toledo II 1.6	1999-00
A3 1.6, Sportback	2004 ->	Toledo III 1.6	2004-09
A4 1.6, Avant	1994-00	SKODA	
SEAT		Fabia 2.0	1999-08
Alhambra 2.0 i	1996-10	Fabia 2.0, Combi, Sedan	1999-07
Altea 1.6	2004 ->	Octavia 1.6, Combi	1997-07
Altea XL 1.6	2006 ->	Superb 2.0	2002-08
Cordoba 1.6, Fastback, Vario	1999-02		
Cordoba 2.0	2002-09		
Ibiza III 1.6	1999-02		
Ibiza IV 2.0	2002-09		
Leon 1.6	1999-06		

VOLKSWAGEN			
Bora 1.6, Kombi	1998-05		
Bora 2.0	1998-05		
Bora 2.0 4motion, Kombi	2000-05		
Bora 2.0 Kombi	1999-05		
Caddy III 1.6	2004 ->		
Golf IV 1.6, Variant	1997-00		
Golf IV 2.0	1998-04		
Golf IV 2.0 4motion, Variant	2000-05		
Golf IV 2.0 Variant	1999-06		
Golf Plus 1.6	2005 ->		
Golf V 1.6	2004-08		
Golf V 1.6 Variant	2007 ->		
Jetta III 1.6	2005-10		
Multivan V 2.0	2003 ->		
New Beetle 1.6	1999-00		
New Beetle 2.0	1998 ->		
Passat 1.6, Variant	1996-00		
Passat 2.0	2000-05		
Passat 2.0, 4motion, Variant	2000-05		
Polo 1.6 Variant	1997-01		
Polo 100 1.6 Classic	1995-01		
Transporter V 2.0	2003 ->		

Ref. 85876

Supplied up to exhausting stock / Suministrado hasta agotar existencias / Fourni jusqu'a épuisement du stock

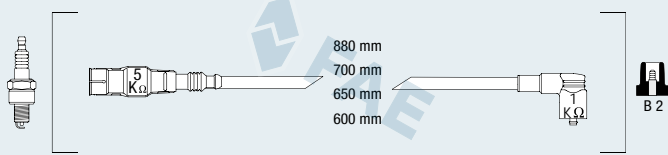

SEAT		VOLKSWAGEN	
Arosa 1.0 i	1997 ->	Lupo 1.0 i	1998 ->
Arosa 1.4 i	1997 ->	Lupo 1.4 FSI	2000-05
		Lupo 1.6 GTI	2000-05

Ref. 85878

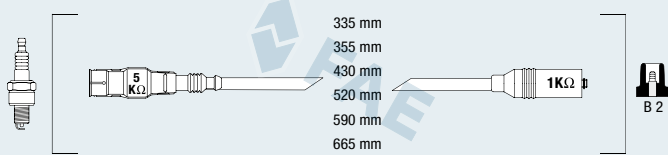

AUDI		AUDI Cont.	
100 2.6 i, Avant, Quattro,	1992-94	A8 2.8 i, Quattro	1994-96
100 2.8 i, E, Quattro	1990-94	Cabriolet 2.6 i	1993-00
80 2.6 i, E, Quattro	1992-95	Cabriolet 2.8 i	1992-00
80 2.8 i, Avant, Quattro	1992-97	Coupe 2.6 i, Quattro	1992-96
A4 2.4 i, Avant	1995-97	Coupe 2.8 i, Quattro	1991-96
A4 2.6 i, Avant, Quattro	1995-97		
A4 2.8 i, Avant, Quattro	1996-96		
A6 2.4 i	1995-97		
A6 2.6 i, Avant, Quattro	1994-97		
A6 2.8 i, Avant, Quattro	1994-97		

Ref. 85879

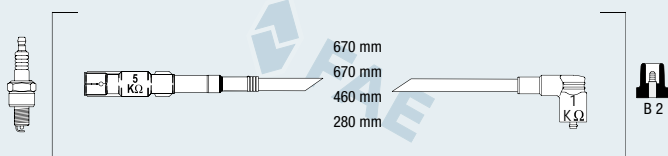

AUDI		VOLKSWAGEN	
A3 1.6	2000 ->	Bora 1.6	2000-05
A3 1.6, Sportback	2003 ->	Bora 1.6 Kombi	2000-05
A4 1.6, Avant	2000-04	Golf IV 1.6	2000-05
SKODA		Golf IV 1.6 Variant	2000-06
Octavia 1.6, Combi	2004 ->	New Beetle 1.6	2000 ->
Octavia 2.0	1999-07	New Beetle 1.6 Cabrio	2003-10
Octavia 2.0 Combi	1999-07	Touran 1.6	2003-10

Ref. 85890

Supplied up to exhausting stock / Suministrado hasta agotar existencias / Fourni jusqu'a épuisement du stock

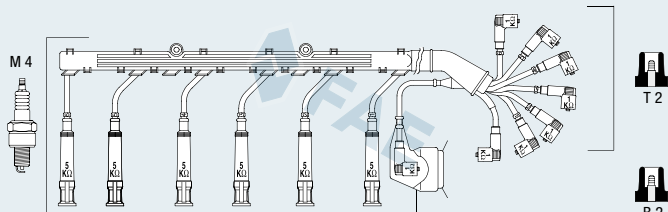

BMW			
320-6 (E21 / M10)	1980-82		
320 i, ic. (E30)	1985-87		
323 i (E30)	1985-87		
520 E Cat.	1983-87		
520 i (E28)	1986-88		
525 E Cat.	1983-87		
Engines/Motors/Moteurs:			
M 20 6 cil.			



Ref. 85910

Supplied up to exhausting stock / Suministrado hasta agotar existencias / Fourni jusqu'a épuisement du stock

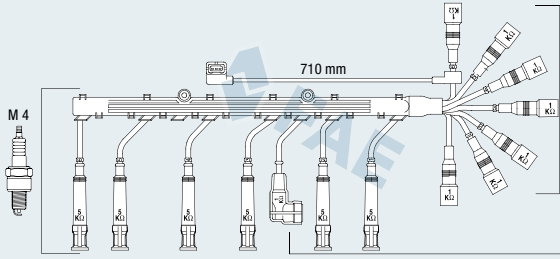

BMW			
320 i, Cabrio, Touring	1986-93		
325 i X	1986-87		
325 i X, Touring	1986-91		
325 i, Cabrio	1983-89		
325 i, Cabrio, Touring	1986-91		
520 i	1986-90		
520 i 24V, Touring	1989-95		
525 e 2.7	1981-87		
525 i	1988-91	Engines/Motores/Moteurs:	
		M 20 6 cil.	

Ref. 85920

Supplied up to exhausting stock / Suministrado hasta agotar existencias / Fourni jusqu'a épuisement du stock

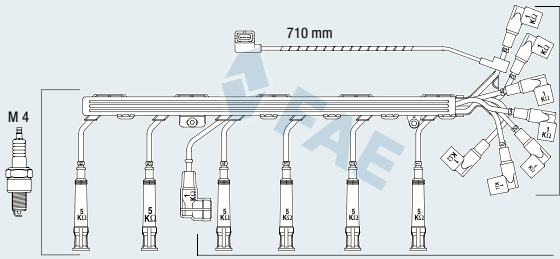

BMW			
525 i	1988-91		
530 i (E34)	1984-88		
535 i (E34)	1984-88		
730 i, il. (E32)	1986-94		
735 i, il. (E32)	1986-92		
		Engines/Motores/Moteurs:	
		M 30 6 cil.	

Ref. 85930

Supplied up to exhausting stock / Suministrado hasta agotar existencias / Fourni jusqu'a épuisement du stock

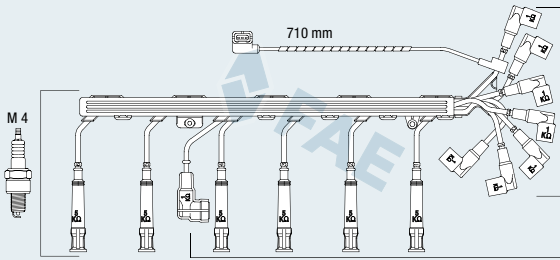

BMW		BMW Cont.	
530 i	1988-91	735 i,iL	1986-87
535 i	1988-95	745 i	1980-83
535 i, M 535 i	1985-87	M5 3.5	1985-87
628 CSi	1979-87		
635 Csi	1978-88		
728 i	1978-86		
730	1977-79		
730 i,iL	1986-94		
733 i	1977-79	Engines/Motores/Moteurs:	
735 i	1979-86	M 30 6 cil.	

Ref. 85940

Supplied up to exhausting stock / Suministrado hasta agotar existencias / Fourni jusqu'a épuisement du stock

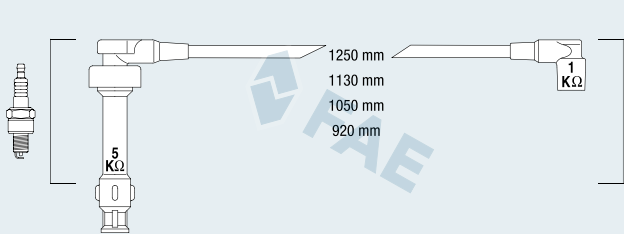

BMW			
318 is	1989-91		
318 is, Coupe	1992-95		
318 ti Compact	1994-95		
Z3 1.9	1995-99		
		Engines/Motores/Moteurs:	
		M42 4 cil.	

Ref. 85945 NEW

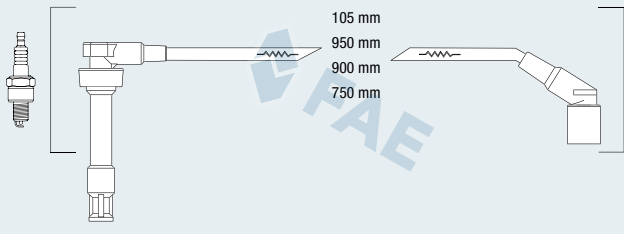

BMW			
318 is, Coupe	1992-95		
318 ti Compact	1994-95		
Z3 1.9	1995-99		

Ref. 85950

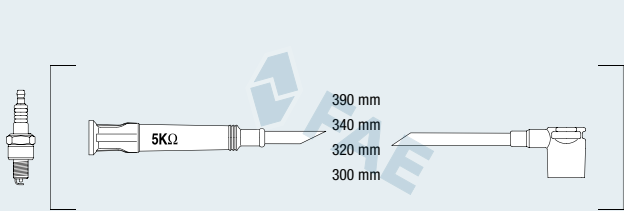

BMW			
316 g Compact	1995-00		
316 i	1990-93		
316 i, Compact	1998-00		
316 i, Compact, Coupe, Touring	1993-98		
318 i, Cabrio, Touring	1993-98		
318 is, Coupe	1993-98		
Z3 1.8	1995-98		
Z3 1.9	1998-03	Engines/Motores/Moteurs:	
		M 43.	

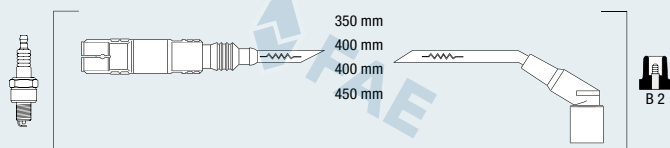
Ref. 85955 NEW

BMW			
316 Ci Coupe	2000 ->		
316 i	2000-05		
316 i, Compact	1998-00		
318 Ci Cabrio, Coupe	2001 ->		
318 Ci Coupe	1999-01		
318 i, Cabrio, Touring	1993-98		
318 i, Touring	1998-01		
518 i, Touring	1989-95		
Z3 1.8	1995-98		
Z3 1.9	1998-03		

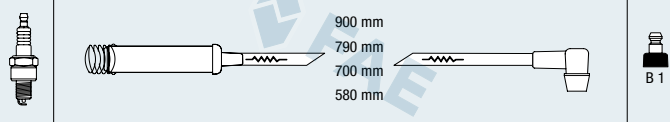
Ref. 85960

DAEWOO			
Aranos 2.0 CD (C20LZ)	1995 ->		
Cielo DLX	1994 ->		
Espero 1.8	1995-99		
Espero 2.0 CD (C20LZ)	1995-99		
Nexia 1.5	1995-97		
Nubira 1.8	1997-99		
Nubira 1.8 Wagon	1997-99		

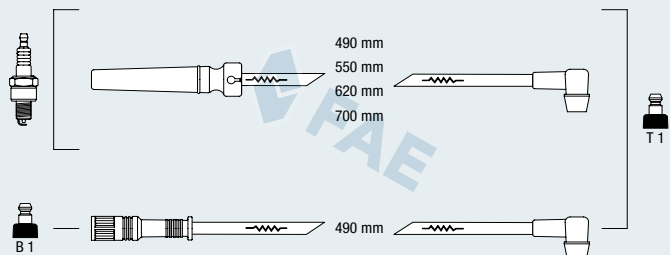
Ref. 85970

DAEWOO			
Aranos 1.5 GLX 16V	1995 ->		
Espero 1.5 GLX 16V	1995-99		
Nexia 1.5 GLX 16V	1995-97		
Nexia 1.5 GTX 16V	1995-97		
Nexia 1.5 16V 90 cv.	1995-97		

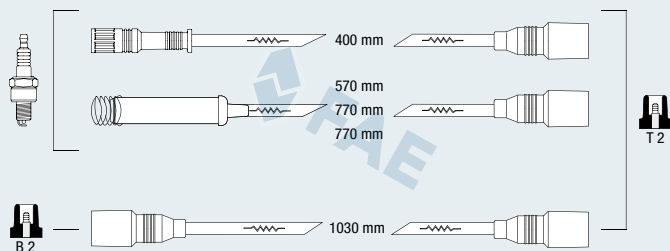
Ref. 85980

OPEL		VAUXHALL	
Frontera A 2.0 i Sport	1992-98		
Omega A 1.8 N	1986-87		
Omega A 1.8 N Caravan	1986-87		
Omega A 1.8 S, Caravan	1986-94		
Omega A 1.8, Caravan	1986-94		
Omega A 2.0 i, Caravan	1986-94		
Omega A 2.0, Caravan	1986-94		
Omega B 2.0	1994-00		
Omega B 2.0, Caravan	1994-99	Engines/Motores/Moteurs: C20NE 115 cv.	

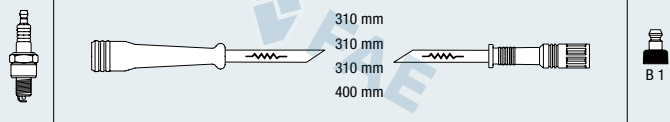
Ref. 85985

RENAULT		RENAULT Cont.	
Espace III 2.0	1996-00	Megane I 2.0 i Coach	1999-03
Laguna 1.8	1993-01	Megane I 2.0 i, Classic, Coach	1996 ->
Laguna 1.8, Grandtour	1995-01	Megane Scenic 2.0 i	1997-99
Laguna 2.0	1993-01		
Laguna 2.0, Grandtour	1993-01		
Megane I 2.0 16V, Cabrio, Coach	1996-99		
Megane I 2.0 Cabrio	1997 ->		
Megane I 2.0 i	1999 ->		
Megane I 2.0 i Cabrio	1999 ->	Engines/Motores/Moteurs: F3P, F3R.A	
Megane I 2.0 i Classic	1999 ->		

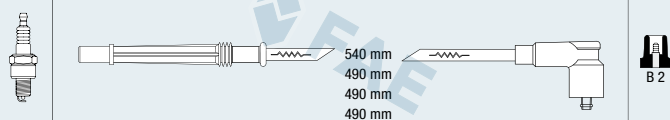
Ref. 85988 NEW

DACIA		RENAULT	
Logan 1.2 16V	2006 ->	Clio 1.2 16V Grandtour	2008 ->
Sandero 1.2 16V	2008 ->	Clio 1.2 16V Grandtour, Hi-Flex	2008 ->
NISSAN		Clio II 1.2 16V	2001 ->
Kubistar 1.2 16V	2006 ->	Clio III 1.2 16V	2005 ->
		Clio III 1.2 16V, Hi-Flex	2005 ->
		Kangoo 1.2 16V	2001 ->
		Kangoo 1.2 16V Express	2001 ->
		Modus 1.2	2004 ->
		Modus 1.2, Hi-Flex	2004 ->
		Twingo 1.2 16V	2001 ->

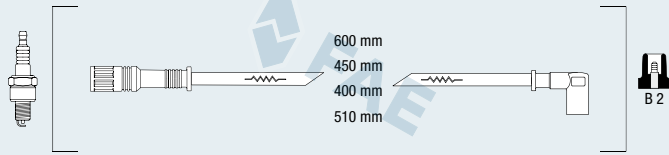
**Ref. 85990**

RENAULT			
Clio I 1.2	1996-98		
Clio II 1.1 Furgón	1998 ->		
Clio II 1.2	1998 ->		
Clio II 1.2 Furgón	1999-03		
Kangoo 1.2, Express	1997 ->		
Twingo 1.2	1996 ->		
Twingo 1.2 16V	2004 ->		
Engines/Motores/Moteurs:			
D7F.			

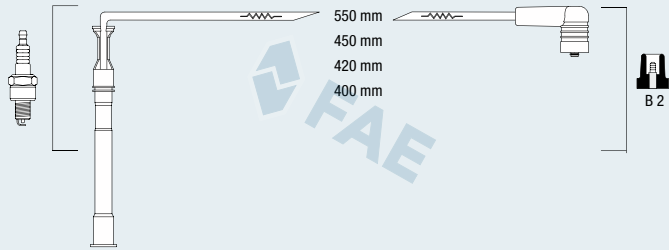
Ref. 85991

NISSAN		RENAULT	
Kubistar 1.2 i	2003 ->	Clio 1.2 16V Grandtour	2008 ->
		Clio II 1.1 Furgón	1998 ->
		Clio II 1.2	1998 ->
		Clio II 1.2 Furgón	1999-03
		Kangoo 1.2, Express	1997 ->
		Modus 1.2 16V	2007 ->
		Twingo 1.2	1996 ->
		Twingo 1.2 Turbo	2007 ->

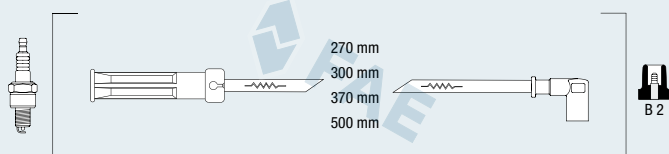
Ref. 85994

RENAULT Cont.			
Megane I 1.6 i, Classic	1996-99		
Megane Scenic 1.6 e	1997-99		
Megane Scenic 1.6 i	1997-99		
Thalia 1.4	2000 ->		

DACIA		RENAULT	
Logan 1.4	2004 ->	Clio II 1.4	1998-05
Logan 1.4 Express	2009 ->	Kangoo 1.4	1997 ->
Logan 1.4 MCV	2007 ->	Kangoo 1.4 Express	1997 ->
Logan 1.4 MPI LPG	2006 ->	Kangoo 1.6 16V bivalent	2005 ->
Logan 1.6	2004 ->	Logan 1.4, Kombi	2004 ->
Logan 1.6 16V MCV Bifuel	2008 ->	Logan 1.6	2007 ->
Logan 1.6 Express	2009 ->	Logan 1.6 Kombi	2007 ->
Logan 1.6 MCV	2007 ->	Logan 1.6, Kombi	2004 ->
Logan 1.6 Pick-up	2008 ->	Megane I 1.4 e Grandtour	1999 ->
Sandero 1.4	2008 ->	Megane I 1.4 e, Classic	1996 ->
Sandero 1.6	2008 ->	Megane I 1.6 e Cabrio, Coach	1996-99
Solenza 1.4	2003 ->	Megane I 1.6 e, Classic	1996-99

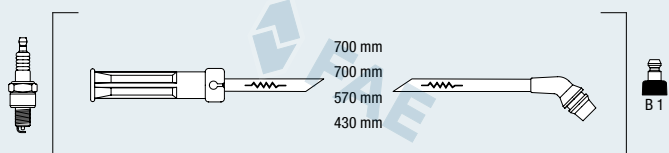
Ref. 85995

RENAULT			
Megane 1.6i RN,RT,RXE	1995-96		
Megane Classic 1.6 i	1995-96		
Megane Coach 1.6 i	1995-96		
Megane Cabriolet 1.6 i	1997-99		
Megane Coupe 1.6 i	1996 ->		
Megane Roadster 1.6 i	1997 ->		
Scenic 1.6i RTA,RTE,RTX	1996-99		
Engines/Motores/Moteurs:			
K7M. 90 cv.			

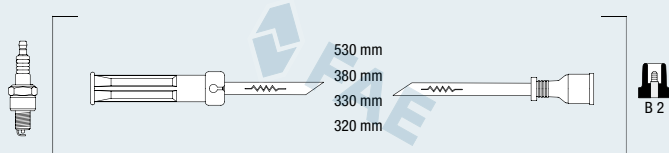
Ref. 85996

RENAULT			
Clio II 1.4	1998-05		
Clio II 1.6	1998-05		
Kangoo 1.4	1997 ->		
Kangoo 1.4 Express	1997 ->		
Laguna 1.6 16V, Grandtour	1997-01		
Megane I 1.6 e Cabrio, Coach	1996-99		
Megane I 1.6 e, Classic	1996-99		
Megane I 1.6 i, Classic	1996-99		
Megane Scenic 1.6 e	1997-99		
Megane Scenic 1.6 i	1997-99		



Ref. 85997

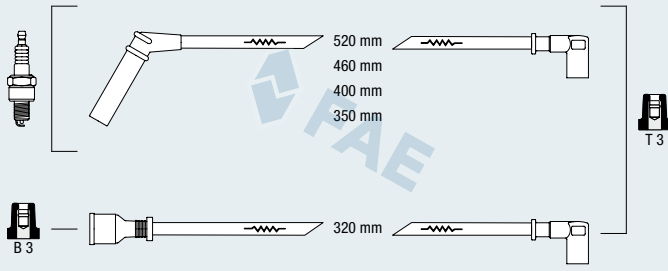

HYUNDAI			
Atos 1.0 i, Prime	1998-02		
S 1.5 i Coupe Turbo	1991-96		

Ref. 85998

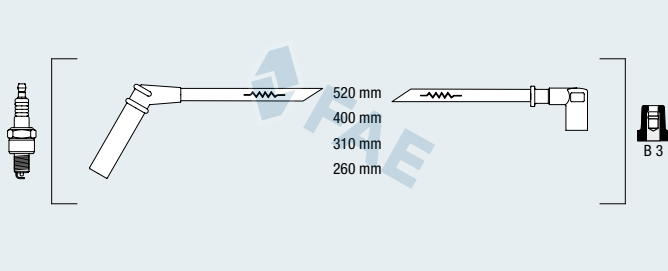

HYUNDAI		KIA	
Accent 1.3	2002 ->	Picanto 1.0	2005 ->
Accent 1.3 i 12V, Sedan	1994-00	Picanto 1.1	2004 ->
Accent 1.3, Sedan	1994-00		
Accent 1.5 i 12V, Sedan	1994-00		
Accent 1.5 i 16V, Sedan	1995-00		
Accent 1.5, Sedan	2000 ->		
Atos 1.0 i, Prime	1998-02		
Getz 1.1	2002 ->		
Getz 1.3	2002 ->		
Lantra II 1.5 12V, Wagon	1997 ->		

Ref. 85999

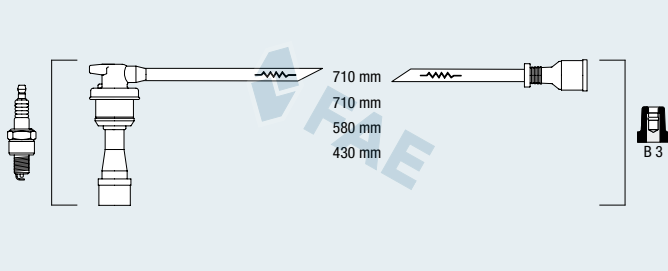

HYUNDAI		KIA	
Elantra 1.6 i	1990 ->	Colt III 1.6 GTi 16V	1988-90
Elantra 1.8 i	1992 ->	Colt III 1.8 GTi 16V Kat	1990-92
Lantra 1.6 i 16V	1990-95	Colt IV 1.8 GTi 16V	1992-96
Lantra 1.8 i 16V	1990-95	Eclipse I 2.0 i 16V, 4x4	1991-95
Santamo 2.0 16V	1999 ->	Eclipse II 2000 GS 16V	1995-99
Sonata 2.0 i (G4ZP)	1991-98	Eclipse II 2000 GT 16V	1995-99
		Galant IV 2.0 GTi 16V, 4x4, Sedan, Kat	1988-92
		Lancer IV 1.8 GTi 16V	1989-92
		Santamo 2.0 16V	1999 ->
		Santamo 2.0 16V 4x4	1999 ->

Ref. 86000

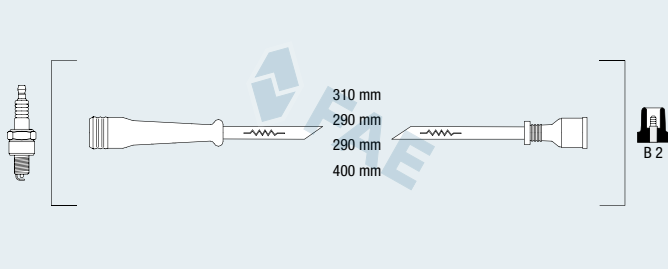

RENAULT		RENAULT Cont.	
Espace III 2.0	1996-00	Megane I 2.0 i Coach	1999-03
Laguna 1.8	1993-01	Megane I 2.0 i, Classic, Coach	1996 ->
Laguna 1.8, Grandtour	1995-01	Megane Scenic 2.0 i	1997-99
Laguna 2.0	1993-01		
Laguna 2.0, Grandtour	1993-01		
Megane I 2.0 16V, Cabrio, Coach	1996-99		
Megane I 2.0 Cabrio	1997 ->		
Megane I 2.0 i	1999 ->		
Megane I 2.0 i Cabrio	1999 ->		
Megane I 2.0 i Classic	1999 ->		

Ref. 86010

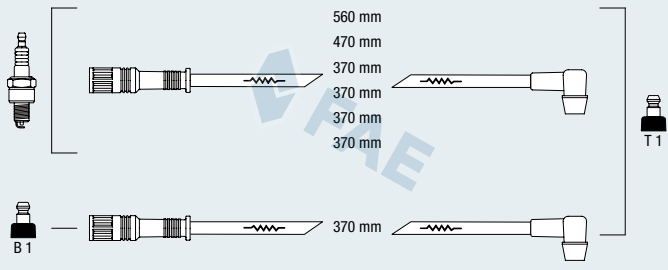

JEEP			
Cherokee 4.0 184 cv.	1995 ->		
Grand Cherokee 4.0 180 cv.	1995-99		
Grand Cherokee 4.0 185 cv.	1989-99		
Wrangler 4.0	1987-89		
Wrangler 4.0 Laredo 184 cv.	1995 ->		
Wrangler 4.0 Hard Top	1995 ->		

Ref. 86020

Supplied up to exhausting stock / Suministrado hasta agotar existencias / Fourni jusqu'a epuïsement du stock

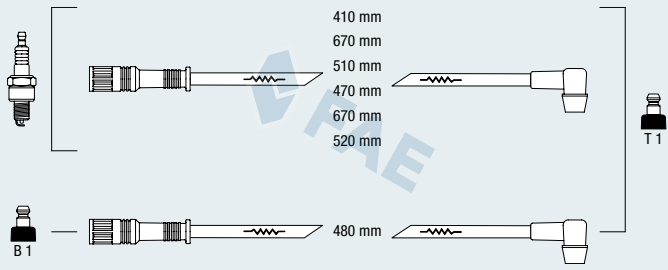

CHRYSLER		DODGE	
Voyager I 3.3	1989-90	Caravan III 3.3	2000 ->
Voyager II 3.3 i	1990-95	Caravan III 3.3 AWD	2000 ->
Voyager II 3.3 i, AWD	1990-95		
Voyager III 3.3 i	1995-01		



HYPALON

Supplied up to exhausting stock / Suministrado hasta agotar existencias / Fourni jusqu'a épuisement du stock



- L = 1200 mm. Ref. **87010**
- L = 1000 mm. Ref. **87020**
- L = 750 mm. Ref. **87040**
- L = 600 mm. Ref. **87050**
- L = 500 mm. Ref. **87060**
- L = 400 mm. Ref. **87070**
- L = 300 mm. Ref. **87080**



- L = 850 mm. Ref. **87210**
- L = 750 mm. Ref. **87220**
- L = 600 mm. Ref. **87230**
- L = 500 mm. Ref. **87240**
- L = 400 mm. Ref. **87250**
- L = 300 mm. Ref. **87260**

Lenght
Longitud
Longueur

Ø 7 mm. Hypalon Lead.
Cable Hypalon Ø 7 mm.
Câble Hypalon Ø 7 mm.

SILICONE / SILICONA / SILICONE

Supplied up to exhausting stock / Suministrado hasta agotar existencias / Fourni jusqu'a épuisement du stock



- L = 350 mm. Ref. **88500**
- L = 500 mm. Ref. **88510**
- L = 650 mm. Ref. **88520**
- L = 800 mm. Ref. **88530**
- L = 1000 mm. Ref. **88540**



- L = 650 mm. Ref. **88560**
- L = 800 mm. Ref. **88570**



- L = 600 mm. Ref. **88580**
- L = 750 mm. Ref. **88590**



- L = 650 mm. Ref. **88610**
- L = 800 mm. Ref. **88620**



- L = 500 mm. Ref. **88640**
- L = 650 mm. Ref. **88650**
- L = 800 mm. Ref. **88660**



- L = 1000 mm. Ref. **88700**



- L = 650 mm. Ref. **88740**



- L = 350 mm. Ref. **88900**
- L = 500 mm. Ref. **88910**
- L = 650 mm. Ref. **88920**
- L = 800 mm. Ref. **88930**
- L = 1000 mm. Ref. **88940**

Lenght
Longitud
Longueur

Ø 7 mm. Hypalon Lead.
Cable Hypalon Ø 7 mm.
Câble Hypalon Ø 7 mm.